



2022

REPORT ON PROPOSALS

THE WATER EFFICIENCY AND SANITATION STANDARD
TECHNICAL COMMITTEE REPORT ON PROPOSALS FOR
PUBLIC REVIEW AND COMMENT

Information on IAPMO Codes and Standards Development

1. Applicable Regulations. The primary rules governing the processing of the *Water Efficiency and Sanitation Standard* are the *IAPMO Regulations Governing Consensus Development of WE•Stand*. Other applicable rules include the *Guide for the Conduct of Participants in the IAPMO Codes and Standards Development Process*. For copies of these documents, contact the Code Development Department at IAPMO World Headquarters at 4755 E. Philadelphia Street, Ontario, CA 91761-2816 USA, or at 909-472-4100. These documents are also available at the IAPMO website at www.iapmo.org.

The following is general information on the IAPMO process. All participants, however, should refer to the actual rules and regulations for a full understanding of this process and for the criteria that govern participation.

2. Technical Committee Report (TCR). The Technical Committee Report is defined as “the Report of the Technical Committee, consisting of the Report on Proposals (ROP), as modified by the Report on Comments (ROC), published by the Association.”

3. Report on Proposals (ROP). The ROP is defined as “a report to the Association on the actions taken by Technical Committees, accompanied by a ballot statement and one or more proposals on text for a new Document or to amend an existing Document.” The ROP and the ROC together comprise the Technical Committee Report. Anyone who does not pursue an issue, either in person or by designated representative in accordance with Section 7.0 (Public Review and Comment of the Regulations Governing Consensus Development), as a proposed amendment of the Report on Proposals will be considered as having their objection resolved.

4. Report on Comments (ROC). The ROC is defined as “a report to the Association on the actions taken by Technical Committees, accompanied by a ballot statement and one or more comments resulting from public review of the Report on Proposals (ROP).” The ROP and the ROC together constitute the Technical Committee Report. Anyone who does not pursue an issue, either in person or by designated representative in accordance with Section 8.0 (Public Review and Comment of the Regulations Governing Consensus Development), as a proposed amendment of the Report on Comments will be considered as having their objection resolved.

5. Appeals. Anyone can appeal to the *Executive Committee* concerning procedural or substantive matters related to the development, content, or issuance of any Document of the Association or on matters within the purview of the authority of the Committee. Such appeals must be in written form and filed with the Secretariat (See 9.0 of the Regulations Governing Consensus Development of WE•Stand). Time constraints for filing an appeal must be in accordance with Section 9.0. Objections are deemed to be resolved if not pursued at this level.

6. Document Issuance. The WE•Stand Executive Committee is the issuer of the *Water Efficiency and Sanitation Standard*. The committee acts on the issuance of a Document within sixty days from the date of the recommendation from the ROC Technical Committee Meeting, unless this period is extended by the Executive Committee.



International Association of Plumbing and Mechanical Officials

4755 East Philadelphia Street
Ontario, California – USA 91761-2816

Ph: 909.472.4100 | Fax: 909.472.4150
<http://www.iapmo.org>

Hugo Aguilar
Recording Secretary
IAPMO Executive
Committee

To: IAPMO Members and Other Interested Parties

Date: September 23, 2022

Enclosed is your 2022 Report on Proposals (ROP).

Billy Smith
Chairman
WE•Stand

These proposals were presented to the WE•Stand Technical Committee members who met in Ontario, California on June 22-23, 2022.

All comments for consideration by the Technical Committee should be submitted to IAPMO by January 13, 2023.

On May 17-18, 2023, the Technical Committee will consider all the comments received in response to the actions contained within the ROP for the WE•Stand and will vote on whether to modify any of their previous actions.

THE BALLOT RESULTS ON ALL COMMITTEE ACTIONS ON PROPOSALS PASSED EXCEPT FOR THE FOLLOWING TWO ACTIONS:

ITEM 046	FAILED TO ACHIEVE THE NECESSARY 2/3 AFFIRMATIVE VOTE OF RETURNED BALLOTS.
ITEM 047	FAILED TO ACHIEVE THE NECESSARY 2/3 AFFIRMATIVE VOTE OF RETURNED BALLOTS.
ITEM 055	FAILED TO ACHIEVE THE NECESSARY 2/3 AFFIRMATIVE VOTE OF RETURNED BALLOTS.
ITEM 079	FAILED TO ACHIEVE THE NECESSARY 2/3 AFFIRMATIVE VOTE OF RETURNED BALLOTS.
ITEM 107	FAILED TO ACHIEVE THE NECESSARY 2/3 AFFIRMATIVE VOTE OF RETURNED BALLOTS.
ITEM 121	FAILED TO ACHIEVE THE NECESSARY 2/3 AFFIRMATIVE VOTE OF RETURNED BALLOTS.
ITEM 133	FAILED TO ACHIEVE THE NECESSARY 2/3 AFFIRMATIVE VOTE OF RETURNED BALLOTS.

In accordance with Section 6.8.2 of the Regulations Governing Consensus Development of the Water Efficiency and Sanitary Standard where the technical committee actions failed to achieve the necessary 2/3 affirmative vote, a public comment is requested for each proposal listed above. All proposals listed above shall be reconsidered by the technical committee as an automatic public comment.



2023 WE-STAND TECHNICAL COMMITTEE

(As of 06/10/22)

NAME	REPRESENTATION	CLASSIFICATION
Billy Smith, Chair	American Society of Plumbing Engineers (ASPE)	Design Professional
Charles Campbell	Topeka Winsupply Co.	Consumer
Edward Osann	Natural Resources Defense Council (NRDC)	Consumer
Gary Klein	Gary Klein and Associates, Inc.	Design Professional
Todd Kuchta	Self	Design Professional
Pat Lando	Recode	Design Professional
John Lansing	PAE Consulting Engineers	Design Professional
Rick Layton	Haines, Jones & Cadbury, LLC	Design Professional
Damon Premer	ACCO	Enforcing Authority
Amir Tabakh	City of LA Department of Water and Power	Enforcing Authority
Charles White	PHCC-National Association	Installer/Maintainer
Jeff Williams	Southern Botanical	Installer/Maintainer
Brian Granger	UA Plumbers Local 68	Labor
James Majerowicz	Plumbers Local Union 130 U A	Labor
David Mann	CA State Pipe Trades Council	Labor
Shawn Crawford	Rainwater Management Solutions	Manufacturer
Michael Cudahy	Plastic Pipe & Fittings Association	Manufacturer
Cambria McLeod	Kohler Co.	Manufacturer
Avishai Moscovich	Reed Water	Manufacturer
Kyle Thompson	Plumbing Manufacturers International (PMI)	Manufacturer
Laura Allen	Greywater Action	Special Expert
John Koeller	Koeller and Company	Special Expert
Markus Lenger	CleanBlu Innovations Inc	Special Expert
Thomas Pape	Alliance for Water Efficiency	Special Expert
Beverly Potts	Illinois PHCC	Special Expert
Steven Braband	BioSolutions Inc	User
Jim Kendzel	ASA International	User
Robert Sewell	Lescure Company, Inc.	User
Kent Sovocool	Southern Nevada Water Authority	User
Tracy Strahl, Principal Samantha Barnes, Alternate	Water Quality Association (WQA)	User
Taylor Duran	IAPMO Staff	

FORM FOR COMMENTS ON IAPMO WESTAND COMMITTEE DOCUMENTS-2020

NOTE: All Comments MUST be received by 5:00 PM PST on January 13, 2023

PLEASE USE SEPARATE FORM FOR EACH COMMENT

Forms to be submitted electronically and accessed at the following:

https://codes.iapmo.org/form_comments_WESTand_2023.aspx

Date _____ Name _____ Tel. No. _____

Organization _____ Email Address _____

Street Address _____ City _____ State _____ Zip _____

Please Indicate Organization Represented (if any) _____

Recommendation:

Check one (see instructions)
<input type="checkbox"/> Accept as Submitted
<input type="checkbox"/> Accept as Modified
<input type="checkbox"/> Reject

Section number: _____ Code: WE•Stand <input type="radio"/>
Comment on Proposal Item number: _____
Proposed Text [Note: Proposed text must be in legislative format i.e., using underscore to denote wording to be inserted (<u>wording</u>) and strike through to denote wording to be deleted (wording)].

Statement of Problem and Substantiation/Resolution:
--

Are you referencing standards in your comment? Check one <input type="checkbox"/> Yes <input type="checkbox"/> No
<u>If yes, please provide two hard copies or one electronic copy with your comment. Please note that if a standard is referenced above in your comment you must submit such standard in order for your comment to be processed. If the standard is not received by the closing date, your comment is considered incomplete and will not be processed.</u>

Patent Policy. IAPMO's patent policy is to adhere fully to the ANSI patent policy. Every proponent of a code change proposal should familiarize him or herself with the ANSI patent policy which is available in its entirety at www.ansi.org/essentialrequirements . Upon receipt of a notice of an essential patent claim, IAPMO will coordinate with the claimant to ensure collection of the assurance(s) required by IAPMO's adherence to the ANSI patent policy before the proposal that includes an essential patent claim is introduced into the code development process.

Where additional supplementary materials such as tests, research papers, or other documents need to be submitted, please provide supporting material electronically. <u>Please note that if supporting material is not received by the closing date, it will not be accepted for review by the Technical Committee.</u>
Copyright Assignment (This comment is original materials and is considered to be the submitter's own idea based on, or as a result of, research and experience, and is not copied from another source). I hereby irrevocably grant and assign IAPMO all and full rights in copyright, in this proposal. I understand and intend that I acquire no rights, including rights as a joint author, in any publication of IAPMO in which this comment in this or another similar or analogous form is used. I hereby warrant that I am the author of this comment and that I have full power and authority to enter into this copyright assignment. <input type="checkbox"/> By checking this box I affirm that I am, and agree to be legally bound by the above Copyright Assignment and the terms and conditions contained therein. I understand and intend that, by checking this box, I am creating an electronic signature that will, upon my submission of this form, have the same legal force and effect as a handwritten signature. Note: If you are not the author of this comment (this text is copied from another source) please do not submit. The author of the comment must give copyright assignment (which is the submitter's own idea based on or as a result of research, experience and is not copied from another source).

INSTRUCTIONS FOR SUBMITTING COMMENTS

PLEASE READ CAREFULLY

1. Check the appropriate box to indicate whether this comment recommends adding new text, revising existing text, or delete text without substitution (see examples below).
2. Enter the appropriate comment on proposal item number that the proposed text applies to.
3. In the space identified as "Proposed Text" indicate as follows:
 - Where making a recommendation to "Accept as Submitted", simply state "I request to accept the code change proposal as submitted by this public comment".
 - Where making a recommendation of "Accept as Modified", indicate the exact wording you propose based on the original proposal. (Refer to Examples for applying charging statement for adding text, deleting text and revising text)
 - Where making a recommendation of "Reject", simply state "I request to reject the code change proposal by this public comment".
4. In the space titled, "Statement of Problem and Substantiation/Resolution," state the problem that will be resolved by your recommendation and give the specific reason for your comment.
5. Where referencing a standard in your comment, such standard needs to be submitted in accordance with the Guidelines for Referencing Mandatory Standards. Please provide two hard copies or one electronic copy with your comment. Please note that if the standard is not received by the closing date, your comment is considered incomplete and will not be processed.
6. Where additional supplementary materials such as tests, research papers, or other documents, need to be submitted, please provide supporting material electronically. Please note that if supporting material is not received by the closing date, it will not be accepted for review by the Technical Committee.
7. Check the box for copyright assignment. Please note if you are not the author of this comment (this text is copied from another source) please do not submit the proposed change. The author of the comment must give copyright assignment (which is the submitter's own idea based on or as a result of research, experience and is not copied from another source).

Note: Content of Comments shall be in accordance with Section 7.4.1 of the IAPMO Regulations Governing Consensus Development of the Water Efficiency and Sanitation Standard. **Failure to comply with the above requirements will result in the comment not being processed.** For further information on the standards process, please contact Code Development at 909-472-4111. For technical assistance, please call 909-218-8126, or email alma.ramos@iapmo.org.

Note printed copies of the above referenced documents will not be available at the hearings.

Examples for applying charging statement for adding text, deleting text and revising text

Add new text as follows (applies only when adding a new section or all new text):

Water Service. Piping from the water main or source of water supply to the water distribution piping of the building or premises served irrespective of the water meter location.

Revise text as follows (applies when revising an existing section by deleting text, adding text or both as follows):

Building Supply. The pipe carrying potable water from the water meter or other source of water supply to the building or other point of use or distribution on the lot. Building supply shall also mean water service. Piping from the water main or source of water supply to the water distribution piping of the building or premises served irrespective of the water meter location.

Delete text without substitution (applies when deleting an entire section, table or both as follows):

~~302.0 Iron Pipe Size (IPS) Pipe. Iron, steel, brass and copper pipe shall be standard weight iron pipe size (IPS) pipe.~~

~~306.1 It shall be unlawful for any person to deposit, by any means whatsoever, into any plumbing fixture, floor drain, interceptor, sump, receptor, or device, which is connected to any drainage system, public sewer, private sewer, septic tank, or cesspool, any ashes; cinders; solids; rags; inflammable, poisonous, or explosive liquids or gas; oils; grease; or any other thing whatsoever that would, or could, cause damage to the drainage system or public sewer.~~

TABLE OF CONTENTS

Item #	Code Section	Page #
001	101.0 - 101.6	1
002	101.6.5, Table 1201.1	2
003	102.0 - 102.6	4
004	103.0 - 103.4	6
005	104.0 - 104.3.2	8
006	104.3 - 104.5.6	10
007	105.0, 105.2 - 105.3.3	12
008	106.1	14
009	107.0 - 107.6	15
010	108.0 - 108.2	17
011	201.0 - 202.1	18
012	204.0	19
013	204.0, 206.0, Chapter 7	20
014	204.0, 221.0, Chapter 7	24
015	204.0	28
016	Chapter 2, Chapter 5, Appendix D	29
017	205.0	32
018	205.0	33
019	206.0	34
020	207.0	35
021	209.0	36
022	Chapter 2, Chapter 6	37
023	209.0	44
024	210.0	45
025	214.0	46
026	214.0	47
027	218.0	48
028	220.0	49
029	220.0	50
030	221.0	51
031	221.0	52
032	221.0	53
033	221.0	54
034	221.0	55
035	221.0	56
036	221.0	57
037	225.0	58
038	225.0	59
039	301.0 - 302.2	60
040	301.3 - 301.4.6	62
041	304.0 - 304.1	64
042	305.0 - 305.2	65
043	306.0 - 306.2	66
044	308.0 - 308.1.4, Table 308.1.2	67
045	Table 402.1, Table 1201.1	69
046	402.7	72
047	402.8.1	74
048	402.9 - 402.12, Table 402.11, Table 1201.1	76
049	404.2.5	78
050	404.5	79
051	406.3, Table 1201.1	80
052	407.3, Table 1201.1	82
053	408.3	84
054	409.1	86
055	409.1	87
056	411.1 - 411.1.2, Table 411.1	89

TABLE OF CONTENTS

057	412.4 - 412.5.2	91
058	414.1, Table 1201.1	93
059	214.0, 415.0 - 415.3, 415.20	94
060	415.2, 415.4 - 415.4.3, Table 1201.1	96
061	415.3 - 415.5.2.1	98
062	415.4, Table 1201.1	99
063	415.6, Table 1201.1	100
064	415.6, 415.7, 415.10, Table 1201.1	102
065	214.0, 415.8, 415.9, 415.11	105
066	415.12	106
067	415.13	107
068	415.13.2, Table 1201.1	108
069	415.14 - 415.15, Table 1201.1	109
070	415.16	111
071	415.15 - 415.15.1	112
072	415.17	113
073	418.2, 418.4, Chapter 10, Table 1201.1	114
074	Chapter 5, Appendix C	120
075	Chapter 5	126
076	Chapter 5	127
077	Chapter 5	128
078	223.0, 502.1.1, 502.1.2	130
079	503.1	131
080	503.1.1	133
081	504.2, 504.3	134
082	505.4, 602.17, 1002.1, 1005.4, 1005.5, 1006.3, A 101.4, A 104.5.4	136
083	Chapter 2, 506.2, 506.14	139
084	506.3	143
085	506.6, 506.8, Appendix D	144
086	506.7	146
087	506.12 - 506.12.2	149
088	506.12, 506.12.1	151
089	506.12.3.2, 506.12.5, 506.12.6	153
090	506.12.5	154
091	506.12.8	155
092	506.13.1	156
093	Table 601.5.1	157
094	601.7, Table 1201.1	158
095	601.7, Table 1201.1	160
096	601.10.1	162
097	601.11.2.1, 601.11.2.2, 603.5, 604.5, 902.5, 903.14.2.1, 903.14.2.2	163
098	601.12	165
099	602.6.1	166
100	Table 602.8	167
101	602.13.1	169
102	602.13.2	170
103	602.15.1.3	171
104	603.5, 604.5	172
105	604.7, Table 1201.1	173
106	604.10.2	174
107	Chapter 8	176
108	Chapter 9	182
109	903.1, 903.4, 903.4.1	184
110	903.5 - 903.5.2, 903.5.4, 903.9, Table 1201.1	186
111	903.13, Table 1201.1	188
112	903.13.1 - 903.13.2	190
113	210.0, 1003.7	192

TABLE OF CONTENTS

114	1005.4.1 - 1005.4.2	194
115	A 101.2, A 101.7, Table 1201.1	195
116	A 101.9, A 103.1 - A 103.2	197
117	A 103.1	198
118	A 103.2	199
119	A 104.2.3, Table A 104.2.1, Table A 104.2.3	201
120	A 104.2.3, Table A 104.2.1, Table A 104.2.3	202
121	A 104.3.2	204
122	A 104.5.2.1, A 104.5.2.2	206
123	Appendix C	207
124	Appendix E, E 101.0 - E 101.6	223
125	E 102.0 - E 102.1	226
126	E 103.0 - E 103.7	228
127	E 104.0 - E 104.4.4.1, Figure E 104.1, Table 1201.1	231
128	E 105.0 - E 105.5	237
129	Appendix F, F 101.0 - F 101.4.1	239
130	F 201.0, F 201.1	242
131	602.2, F 301.0 - F 401.2, Table 1201.1	243
132	Figure F 301.1(1) - Figure F 301.1(9)	245
133	Appendix G, Table 1201.1	251
134	Table 1201.1	255
135	Table 1201.1	256
136	Table 1201.1	257
137	Table 1201.1	258
138	Table 1201.1	259
139	Table 1201.1	260
140	Table 1201.1	261
141	Table 1201.1	262
142	Table 1201.1	264
143	Table 1201.1	265

2022 WE•Stand Preprint

Copyright © 2023 [or 2021 or 2022, etc.]

By

International Association of Plumbing and Mechanical Officials

All Rights Reserved



CODES ADMINISTRATION

Proposals

Item #: 001

WEStand 2023 Section: 101.0 - 101.6

SUBMITTER: Jim Majerowicz
Plumbers Local Union 130 U.A.

RECOMMENDATION:
Revise text

101.0 Title, Scope, and General.

101.1 Title. This document shall be known as the "Water Efficiency and Sanitation Standard (WEStand)," shall be cited as such, and will be referred to herein as "this standard."

~~401.4~~**101.2 Scope.** (remaining text unchanged)

~~401.2~~**101.3 Purpose.** (remaining text unchanged)

~~101.4 Unconstitutional.~~ Where a section, subsection, sentence, clause, or phrase of this standard is, for a reason, held to be unconstitutional, such decision shall not affect the validity of the remaining portions of this standard. The legislative body hereby declares that it would have passed this standard, and each section, subsection, sentence, clause, or phrase thereof, irrespective of the fact that one or more sections, subsections, sentences, clauses, and phrases are declared unconstitutional.

~~101.5 Validity.~~ Where a provision of this standard, or the application thereof to a person or circumstance, is held invalid, the remainder of the standard, or the application of such provision to other persons or circumstances, shall not be affected thereby.

~~401.3~~**101.6 Plans Required.** (remaining text unchanged)

(renumber remaining sections)

SUBSTANTIATION:

The introduction to this standard requires additional language to address legitimacy of provisions in the event certain sections are found to be either unconstitutional or invalid. As there are multiple editions of this standard, there exists the possibility for certain provisional language to become invalid where new procedures and policies have been enacted. There also exists the possibility for technical errors within the standard, and such errors should not negate all other listed requirements. In addition, requirements which are deemed unconstitutional should not cause other portions of the standard to become invalid or unenforceable.

COMMITTEE ACTION: ACCEPT AS SUBMITTED

COMMITTEE STATEMENT:

The Technical Committee would like to note that this language correlates with the Uniform Plumbing Code.

TOTAL ELIGIBLE TO VOTE: 30

VOTING RESULTS: AFFIRMATIVE: 28 NOT RETURNED: 2 CRAWFORD, WILLIAMS



CODES ADMINISTRATION

Proposals

Item #: 002

WESStand 2023 Section: 101.6.5, Table 1201.1

SUBMITTER: Markus Lenger
CleanBlu Innovations Inc.

RECOMMENDATION:
Revise text

101.0 Title, Scope, and General.

101.6 Referenced Codes and Standards. (remaining text unchanged)

101.6.5 ~~Solar Renewables.~~ Solar ~~thermal, solar photovoltaic, hydronics, and geothermal~~ energy systems shall be installed in accordance with the Uniform Solar, ~~Hydronics and Geothermal Energy~~ Code (~~USEGUSHGC~~) promulgated by the International Association of Plumbing and Mechanical Officials (IAPMO).

**TABLE 1201.1
REFERENCED STANDARDS**

STANDARD NUMBER-YEAR	STANDARD TITLE	REFERENCED SECTION
IAPMO/ ANSI USHGC 1-2021 USEG 2018*	Uniform Solar, Hydronics and Geothermal Energy Code	101.6.5

(portion of table not shown remains unchanged)

Note: IAPMO/ANSI USHGC 1 meets the requirements for a mandatory referenced standard in accordance with Section 15.0 of IAPMO's Regulations Governing Consensus Development of the Water Efficiency and Sanitation Standard.

SUBSTANTIATION:
Reference to the USHGC has been updated to the most current designation, and Section 101.6.5 has been revised to include reference to the renewable energy systems addressed within the USHGC.

COMMITTEE ACTION: ACCEPT AS AMENDED BY THE TC

101.0 Title, Scope, and General.

101.6 Referenced Codes and Standards. (remaining text unchanged)

101.6.5 Renewables. Solar ~~thermal, solar photovoltaic,~~ hydronics, and geothermal energy systems shall be installed in accordance with the Uniform Solar, Hydronics and Geothermal Code (USHGC) promulgated by the International Association of Plumbing and Mechanical Officials (IAPMO).

**TABLE 1201.1
REFERENCED STANDARDS**

STANDARD NUMBER- YEAR	STANDARD TITLE	REFERENCED SECTION
IAPMO/ANSI USHGC 1- 2021*	Uniform Solar, Hydronics and Geothermal Code	101.6.5

(portion of table not shown remains unchanged)

COMMITTEE STATEMENT:

The proposal is being amended to remove specific reference to both "solar thermal" and "solar photovoltaic" systems. The general reference to "solar, hydronics, and geothermal energy systems" is sufficient and addresses both of these types.

TOTAL ELIGIBLE TO VOTE: 30

VOTING RESULTS: AFFIRMATIVE: 28 NOT RETURNED: 2 CRAWFORD, WILLIAMS



CODES ADMINISTRATION

Proposals

Item #: 003

WEStand 2023 Section: 102.0 - 102.6

SUBMITTER: Jim Majerowicz
Plumbers Local Union 130 U.A.

RECOMMENDATION:
Revise text

102.0 Applicability.

~~101.7~~**102.1 Conflicts.** (remaining text unchanged)

~~101.4-2~~**102.2 Existing Construction.** (remaining text unchanged)

~~107.0~~**102.3 Maintenance.** ~~107.1~~**General.** Plumbing and mechanical systems, materials, and appurtenances, both existing and new, and parts thereof shall be maintained in proper operating condition in accordance with the original design and in a safe and hazard-free condition. Devices or safeguards that are required by this standard shall be maintained in conformance with the standard edition under which installed. The owner or the owner's designated agent shall be responsible for maintenance of plumbing and mechanical systems and equipment. To determine compliance with this subsection, the Authority Having Jurisdiction shall be permitted to cause a plumbing or mechanical system or equipment to be reinspected.

~~107.2~~**102.3.1 Information Required.** (remaining text unchanged)

~~101.4-1~~**102.4 Repairs and Alterations Additions, Alterations, Renovations, or Repairs.** ~~In existing buildings or premises in which plumbing and mechanical installations that were designed and installed in accordance with this standard are to be altered, repaired, or renovated, deviations from the provisions of this standard are permitted; provided Additions, alterations, renovations, or repairs shall not cause an existing system to become unsafe, insanitary, or overloaded. Additions, alterations, renovations, or repairs to existing installations shall comply with the provisions for new construction unless~~ such deviations are found to be necessary and are first approved by the Authority Having Jurisdiction.

102.5 Health and Safety. ~~Where compliance with the provisions of this standard fails to eliminate or alleviate a nuisance, or other dangerous or insanitary condition that involves health or safety hazards, the owner or the owner's agent shall install such additional plumbing and mechanical facilities or shall make such repairs or alterations as ordered by the Authority Having Jurisdiction.~~

~~101.5~~**102.6 Appendices.** (remaining text unchanged)

(renumber remaining sections)

SUBSTANTIATION:

The proposed revisions and relocation of sections are required to provide clarification on the applicability of provisions within the standard. This reorganization allows the end user to understand how to apply requirements, address conflicts, and ensure compliance with health and safety criteria.

The current language pertaining to repairs and alterations is insufficient as it does not address compliance with provisions for new construction. This is pertinent to specify as it promotes health and safety by ensuring the most current requirements are implemented. Furthermore, the new language clarifies that additions, alterations, renovations, and repairs are all required to comply with this section.

Proposed Section 102.5 is necessary as it addresses possible health and safety concerns which may not be completely covered by this standard. There always exists the possibility for conditions which are not entirely predictable and are therefore not included. In addition, where the standard fails to ensure health and safety, there must exist language which requires approval from the Authority Having Jurisdiction.

COMMITTEE ACTION: ACCEPT AS SUBMITTED

COMMITTEE STATEMENT:

The Technical Committee would like to note that this language correlates with the Uniform Plumbing Code and provides guidance to jurisdictions without established administrative requirements.

TOTAL ELIGIBLE TO VOTE: 30

VOTING RESULTS: AFFIRMATIVE: 28 NOT RETURNED: 2 CRAWFORD, WILLIAMS



CODES ADMINISTRATION

Proposals

Item #: 004

WESand 2023 Section: 103.0 - 103.4

SUBMITTER: Jim Majerowicz
Plumbers Local Union 130 U.A.

RECOMMENDATION:
Add new text

103.0 Duties and Powers of the Authority Having Jurisdiction.

103.1 General. The Authority Having Jurisdiction shall be the authority duly appointed to enforce this standard. For such purposes, the Authority Having Jurisdiction shall have the powers of a law enforcement officer. The Authority Having Jurisdiction shall have the power to render interpretations of this standard and to adopt and enforce rules and regulations supplemental to this standard as deemed necessary in order to clarify the application of the provisions of this standard. Such interpretations, rules, and regulations shall comply with the intent and purpose of this standard. In accordance with the prescribed procedures and with the approval of the appointing authority, the Authority Having Jurisdiction shall be permitted to appoint a such number of technical officers, inspectors, and other employees as shall be authorized from time to time. The Authority Having Jurisdiction shall be permitted to deputize such inspectors or employees as necessary to carry out the functions of the standard enforcement agency. The Authority Having Jurisdiction shall be permitted to request the assistance and cooperation of other officials of this jurisdiction so far as required in the discharge of the duties in accordance with this standard or other pertinent law or ordinance.

103.2 Liability. The Authority Having Jurisdiction charged with the enforcement of this standard, acting in good faith and without malice in the discharge of the Authority Having Jurisdiction's duties, shall not thereby be rendered personally liable for damage that accrues to persons or property as a result of an act or by reason of an act or omission in the discharge of duties. A suit brought against the Authority Having Jurisdiction or employee because of such act or omission performed in the enforcement of provisions of this standard shall be defended by legal counsel provided by this jurisdiction until final termination of such proceedings.

103.3 Applications and Permits. The Authority Having Jurisdiction shall be permitted to require the submission of plans, specifications, drawings, and such other information in accordance with the Authority Having Jurisdiction, prior to the commencement of, and at a time during the progress of, work regulated by this standard. The issuance of a permit upon construction documents shall not prevent the Authority Having Jurisdiction from thereafter requiring the correction of errors in said construction documents or from preventing construction operations being carried on thereunder where in violation of this standard or of other pertinent ordinance or from revoking a certificate of approval where issued in error.

103.3.1 Licensing. Provision for licensing shall be determined by the Authority Having Jurisdiction.

103.4 Right of Entry. Where it is necessary to make an inspection to enforce the provisions of this standard, or where the Authority Having Jurisdiction has reasonable cause to believe that there exists in a building or upon premises a condition or violation of this standard that makes the building or premises unsafe, insanitary, dangerous, or hazardous, the Authority Having Jurisdiction shall be permitted to enter the building or premises at reasonable times to inspect or to perform the duties imposed by the Authority Having Jurisdiction by this standard, provided that where such building or premises is occupied, the Authority Having Jurisdiction shall present credentials to the occupant and request entry. Where such building or premises is unoccupied, the Authority Having Jurisdiction shall first make a reasonable effort to locate the owner or other person having charge or control of the building or premises and request entry. Where entry is refused, the Authority Having Jurisdiction has recourse to every remedy provided by law to secure entry. Where the Authority Having Jurisdiction shall have first obtained an inspection warrant or other remedy provided by law to secure entry, no owner, occupant, or person having charge, care or control of a building or premises shall fail or neglect, after a request is made as herein provided, to promptly permit entry herein by the Authority Having Jurisdiction for the purpose of inspection and examination pursuant to this standard.

(renumber remaining sections)

SUBSTANTIATION:

Chapter 1 (Administration) does not currently provide guidelines on duties and powers of the Authority Having Jurisdiction. Although the standard requires approval from the AHJ in various sections, there is no clarification for the end user or the possible jurisdictions that may adopt the standard as to what the AHJ can and should be doing.

The proposed sections are necessary as they address the AHJ's ability to render interpretations, adopt supplemental rules and regulations, and specify inspectors or enforcing agencies. The provisions also stipulate procedures for implementing right of entry. All new language is consistent with the plumbing code.

COMMITTEE ACTION: ACCEPT AS SUBMITTED

TOTAL ELIGIBLE TO VOTE: 30

VOTING RESULTS: AFFIRMATIVE: 28 NOT RETURNED: 2 CRAWFORD, WILLIAMS



CODES ADMINISTRATION

Proposals

Item #: 005

WESand 2023 Section: 104.0 - 104.3.2

SUBMITTER: Jim Majerowicz
Plumbers Local Union 130 U.A.

RECOMMENDATION:
Revise text

104.0 Permits Issuance.

104.1 Permits Required. It shall be unlawful for any person to construct, install, alter, or cause to be constructed, installed, or altered any composting toilet, urine diversion system, alternate water source system, reclaimed (recycled) water system, stormwater treatment system, rainwater catchment system, or blackwater treatment system in a building or on a premise without first obtaining a permit to do such work from the Authority Having Jurisdiction.

104.2 Exempt Work. A permit shall not be required for the following:

- (1) The stopping of leaks in drains, soil, waste, or vent pipe, provided, however, that a trap, drainpipe, soil, waste, or vent pipe become defective, and it becomes necessary to remove and replace the same with new material, the same shall be considered as new work and a permit shall be procured and inspection made as provided in this standard.
 - (2) The clearing of stoppages, or the repairing of leaks in pipes, valves, or fixtures, provided such repairs do not involve or require the replacement or rearrangement of valves, pipes, or fixtures.
 - (3) Where specified within this standard and approved by the Authority Having Jurisdiction.
- Exemption from the permit requirements of this standard shall not be deemed to grant authorization for work to be done in violation of the provisions of the standard or other laws or ordinances of this jurisdiction.

104.3 Application for Permit. To obtain a permit, the applicant shall first file an application therefore in writing on a form furnished by the Authority Having Jurisdiction for that purpose. Such application shall:

- (1) Identify and describe the work to be covered by the permit for which application is made.
- (2) Describe the land upon which the proposed work is to be done by legal description, street address, or similar description that will readily identify and definitely locate the proposed building or work.
- (3) Indicate the use or occupancy for which the proposed work is intended.
- (4) Be accompanied by construction documents in accordance with Section 104.3.1.
- (5) Be signed by the permittee or the permittee's authorized agent. The Authority Having Jurisdiction shall be permitted to require evidence to indicate such authority.
- (6) Give such other data and information in accordance with the Authority Having Jurisdiction.

104.3.1 Construction Documents. Construction documents, engineering calculations, diagrams, and other data shall be submitted in two or more sets, or in a digital format where permitted by the Authority Having Jurisdiction, with each application for a permit. The construction documents, computations, and specifications shall be prepared by, and designed by, a registered design professional. Construction documents shall be drawn to scale with clarity to identify that the intended work to be performed is in accordance with the standard.

Exception: The Authority Having Jurisdiction shall be permitted to waive the submission of construction documents, calculations, or other data where the Authority Having Jurisdiction finds that the nature of the work applied for is such that reviewing of construction documents is not necessary to obtain compliance with this standard.

104.3.2 Time Limitation of Application. Applications for which no permit is issued within 180 days following the date of application shall expire by limitation, plans and other data submitted for review thereafter, shall be returned to the applicant or destroyed by the Authority Having Jurisdiction. The Authority Having Jurisdiction shall be permitted to exceed the time for action by the applicant for a period not to exceed 180 days upon request by the applicant showing that circumstances beyond the control of the applicant have prevented the action from being taken. No application shall be extended more than once. In order to renew action on an application after expiration, the applicant shall resubmit plans and pay a new plan review fee.

(renumber remaining sections)

SUBSTANTIATION:

Section 104.0 (Permits) is being modified to include subsections that provide clear requirements and exemptions for permits. Within the proposed subsections, the language clearly lists the required information to provide on applications as well as what to include in the construction documents.

This assists with providing clarity on permit requirements applicable to any composting toilet, urine diversion system, alternate water source system, reclaimed (recycled) water system, storm water treatment system, rainwater catchment system, or blackwater treatment system in a building or on a premise. The provided language improves the WE•Stand and is also consistent with the plumbing and mechanical code.

COMMITTEE ACTION: ACCEPT AS SUBMITTED

TOTAL ELIGIBLE TO VOTE: 30

VOTING RESULTS: AFFIRMATIVE: 28 NOT RETURNED: 2 CRAWFORD, WILLIAMS



CODES ADMINISTRATION

Proposals

Item #: 006

WESand 2023 Section: 104.3 - 104.5.6

SUBMITTER: Jim Majerowicz
Plumbers Local Union 130 U.A.

RECOMMENDATION:
Revise text

~~104.3~~**104.4 Permit Fees.** (remaining text unchanged)

~~104.4~~**104.5 Permit Issuance.** (remaining text unchanged)

~~104.2~~**104.5.1 Approved Plans or Construction Documents.** Where the Authority Having Jurisdiction issues the permit where plans are required, the Authority Having Jurisdiction shall endorse in writing or stamp the construction documents "APPROVED." Such approved construction documents shall not be changed, modified, or altered without authorization from the Authority Having Jurisdiction, and the work shall be done in accordance with approved plans.

The Authority Having Jurisdiction shall be permitted to issue a permit for the construction of a part of a gray water system, reclaimed (recycled) water system, on-site treated nonpotable water system, or rainwater catchment system before the entire construction documents for the whole system have been submitted or approved, provided adequate information and detailed statements have been filed in accordance with the pertinent requirements of this standard. The holder of such permit shall be permitted to proceed at the holder's risk without assurance that the permit for the entire building, structure, or system will be granted.

104.5.2 Validity of Permit. The issuance of a permit or approval of construction documents shall not be construed to be a permit for, or an approval of, a violation of the provisions of this standard or other ordinance of the jurisdiction. No permit presuming to give authority to violate or cancel the provisions of this standard shall be valid.

The issuance of a permit based upon plans, specifications, or other data shall not prevent the Authority Having Jurisdiction from thereafter requiring the correction of errors in said plans, specifications, and other data or from preventing building operations being carried on thereunder where in violation of this standard or of other ordinances of this jurisdiction.

104.5.3 Expiration. A permit issued by the Authority Having Jurisdiction under the provisions of this standard shall expire by limitation and become null and void where the work authorized by such permit is not commenced within 180 days from the date of such permit, or where the work authorized by such permit is suspended or abandoned at a time after the work is commenced for a period of 180 days. Before such work is recommenced, a new permit shall first be obtained to do so, and the fee, therefore, shall be one-half the amount required for a new permit for such work, provided no changes have been made or will be made in the original construction documents for such work, and provided further that such suspensions or abandonment has not exceeded 1 year.

104.5.4 Extensions. A permittee holding an unexpired permit shall be permitted to apply for an extension of the under that permit where the permittee is unable to commence work within the time required by this section. The Authority Having Jurisdiction shall be permitted to extend the time for action by the permittee for a period not exceeding 180 days upon written request by the permittee showing that circumstances beyond the control of the permittee have prevented the action from being taken. No permit shall be extended more than once. In order to renew action on a permit after expiration, the permittee shall pay a new full permit fee.

104.5.5 Suspension or Revocation. The Authority Having Jurisdiction shall be permitted to, in writing, suspend or revoke a permit issued under the provisions of this standard where the permit is issued in error or on the basis of incorrect information supplied or in violation of an ordinance or regulation of the jurisdiction.

104.5.6 Retention of Plans. One set of approved construction documents and computations shall be retained by the Authority Having Jurisdiction until final approval of the work covered therein. One set of approved construction documents, computations, and manufacturer's installation instructions shall be returned to the applicant and said set shall be kept on the site of the building or work at times during which the work authorized thereby is in progress.

(renumber remaining sections)

SUBSTANTIATION:

To further support the proposed additions within the previous item, language is also being presented for plans which are approved. Currently, the WE•Stand is lacking requirements within Chapter 1 (Administration) which address such topics, and it would be beneficial to include these provisions to assist users and promote adoption of the standard. The proposed new language strengthens the provisions of the WE•Stand and is also consistent with both the mechanical and plumbing code.

COMMITTEE ACTION: ACCEPT AS SUBMITTED

TOTAL ELIGIBLE TO VOTE: 30

VOTING RESULTS: AFFIRMATIVE: 28 NOT RETURNED: 2 CRAWFORD, WILLIAMS



CODES ADMINISTRATION

Proposals

Item #: 007

WEStand 2023 Section: 105.0, 105.2 - 105.3.3

SUBMITTER: Jim Majerowicz
Plumbers Local Union 130 U.A.

RECOMMENDATION:
Revise text

105.0 Inspections and Testing.

105.2 Required Inspections. New work and such portions of existing systems as affected by new work, or changes, shall be inspected by the Authority Having Jurisdiction to ensure compliance with the requirements of this standard and to ensure that the installation and construction of the plumbing system are in accordance with approved plans. The Authority Having Jurisdiction shall make the following inspections and other such inspections as necessary. The permittee or the permittee's authorized agent shall be responsible for the scheduling of such inspections as follows:

- (1) The underground inspection shall be made after trenches or ditches are excavated and bedded, piping installed, and before backfill is put in place.
- (2) Rough-in inspection shall be made prior to the installation of wall or ceiling membranes.
- (3) Final inspection shall be made upon completion of the installation.

105.2.1 Uncovering. Where a urine diversion system, alternate water source system, reclaimed (recycled) water system, stormwater treatment system, rainwater catchment system, or blackwater treatment system, or part thereof, which is installed, altered, or repaired, is covered or concealed before being inspected, tested, and approved as prescribed in this standard, it shall be uncovered for inspection after notice to uncover the work has been issued to the responsible person by the Authority Having Jurisdiction. The requirements of this section shall not be considered to prohibit the operation of the urine diversion system, alternate water source system, reclaimed (recycled) water system, stormwater treatment system, rainwater catchment system, or blackwater treatment system installed to replace existing equipment serving an occupied portion of the building in the event a request for inspection of such equipment has been filed with the Authority Having Jurisdiction not more than 72 hours after such replacement work is completed, and before a portion of system is concealed by a permanent portion of the building.

105.2.2 Other Inspections. In addition to the inspections required by this standard, the Authority Having Jurisdiction shall be permitted to require other inspections to ascertain compliance with the provisions of this standard and other laws that are enforced by the Authority Having Jurisdiction.

105.2.3 Inspection Requests. It shall be the duty of the person doing the work authorized by a permit to notify the Authority Having Jurisdiction that such work is ready for inspection. The Authority Having Jurisdiction shall be permitted to require that a request for inspection be filed not less than 1 working day before such inspection is desired. Such request shall be permitted to be made in writing or by telephone, at the option of the Authority Having Jurisdiction. It shall be the duty of the person requesting inspections in accordance with this standard to provide access to and means for inspection of such work.

105.2.4 Advance Notice. It shall be the duty of the person doing the work authorized by the permit to notify the Authority Having Jurisdiction, orally or in writing, that said work is ready for inspection. Such notification shall be given not less than 24 hours before the work is to be inspected.

105.2.5 Responsibility. It shall be the duty of the holder of a permit to make sure that the work will stand the test prescribed before giving the notification. The equipment, material, and labor necessary for inspection or tests shall be furnished by the person to whom the permit is issued or by whom inspection is requested.

105.2.6 Reinspections. A reinspection fee shall be permitted to be assessed for each inspection or reinspection where such portion of work for which inspection is called is not complete or where required corrections have not been made. This provision shall not be interpreted as requiring reinspection fees the first time a job is rejected for failure to be in accordance with the requirements of this standard, but as controlling the practice of calling for inspections before the job is ready for inspection or reinspection.

Reinspection fees shall be permitted to be assessed where the approved plans are not readily available to the inspector, for failure to provide access on the date for which the inspection is requested, or for deviating from plans requiring the approval of the Authority Having Jurisdiction.

To obtain reinspection, the applicant shall file an application therefore in writing upon a form furnished for that purpose and pay the reinspection fee. In instances where reinspection fees have been assessed, no additional inspection of the work will be performed until the required fees have been paid.

105.3 Testing of Systems. The urine diversion system, alternate water source system, reclaimed (recycled) water system, stormwater treatment system, rainwater catchment system, or blackwater treatment system shall be tested and approved in accordance with this standard or the Authority Having Jurisdiction. Tests shall be conducted in the presence of the Authority Having Jurisdiction or the Authority Having Jurisdiction's duly appointed representative.

No test or inspection shall be required where a composting toilet, urine diversion system, alternate water source system, reclaimed (recycled) water system, stormwater treatment system, rainwater catchment system, or blackwater treatment system, or part thereof, is set up for exhibition purposes and has no connection with water or the drainage system. In cases where it would be impractical to provide the required water or air tests, or for minor installations and repairs, the Authority Having Jurisdiction shall be permitted to make such inspection as deemed advisable in order to be assured that the work has been performed in accordance with the intent of this standard. Joints and connections in the composting toilet, urine diversion system, alternate water source system, reclaimed (recycled) water system, stormwater treatment system, rainwater catchment system, or blackwater treatment system shall be airtight, gastight and watertight for the pressures required by the test.

105.3.1 Defective Systems. In buildings or premises condemned by the Authority Having Jurisdiction because of an insanitary condition of a composting toilet, urine diversion system, alternate water source system, reclaimed (recycled) water system, stormwater treatment system, rainwater catchment system, or blackwater treatment system, or part thereof, the alterations in such system shall be in accordance with the requirements of this standard.

105.3.2 Retesting. Where the Authority Having Jurisdiction finds that the work will not pass the test, necessary corrections shall be made, and the work shall be resubmitted for test or inspection.

105.3.3 Approval. Where prescribed tests and inspections indicate that the work is in accordance with this standard, a certificate of approval shall be issued by the Authority Having Jurisdiction to the permittee on demand.

SUBSTANTIATION:

The current section provided for inspection and testing is being improved as it now would include provisions for inspection requests, advanced notice of inspection, reinspection, testing of systems, defective systems, and approval.

The current language is insufficient as it only requires inspection after installation is complete. There is no guidance or direction given for scheduling of inspections or any of the topics previously mentioned. Without the new language, the requirements for inspections are lacking and are ambiguous. Additionally, the proposed language is consistent with the layout and content of the plumbing code.

COMMITTEE ACTION: ACCEPT AS SUBMITTED

TOTAL ELIGIBLE TO VOTE: 30

VOTING RESULTS: AFFIRMATIVE: 28 NOT RETURNED: 2 CRAWFORD, WILLIAMS



CODES ADMINISTRATION

Proposals

Item #: 008

WEStand 2023 Section: 106.1

SUBMITTER: Jim Majerowicz
Plumbers Local Union 130 U.A.

RECOMMENDATION:
Revise text

106.0 Connection Approval.

106.1 Connections. No person shall make connection to any plumbing system regulated by this standard for which a permit is required unless approved by the Authority Having Jurisdiction. No person shall make the connection from a water-supply line nor shall connect to a sewer system regulated by this standard and for which a permit is required until approved by the Authority Having Jurisdiction.

SUBSTANTIATION:

The proposed modification is needed to protect the water supply line as well as the sewer system. Requiring approval by the AHJ before connection strengthens the provisions of Section 106.1 (Connections) and correlates with the plumbing code.

COMMITTEE ACTION: REJECT

COMMITTEE STATEMENT:

Since the plumbing system includes both the supply and sewer lines, the proposed new language is redundant. The Technical Committee believes the existing language sufficiently addresses such connections.

TOTAL ELIGIBLE TO VOTE: 30

VOTING RESULTS: AFFIRMATIVE: 28 NOT RETURNED: 2 CRAWFORD, WILLIAMS



CODES ADMINISTRATION

Proposals

Item #: 009

WEStand 2023 Section: 107.0 - 107.6

SUBMITTER: Jim Majerowicz
Plumbers Local Union 130 U.A.

RECOMMENDATION:
Add new text

107.0 Violations and Penalties.

107.1 General. It shall be unlawful for a person, firm, or corporation to erect, construct, enlarge, alter, repair, move, improve, remove, convert, demolish, equip, use, or maintain a urine diversion system, alternate water source system, reclaimed (recycled) water system, stormwater treatment system, rainwater catchment system, or blackwater treatment system, materials, equipment, appurtenances, and other associated components or permit the same to be done in violation of this standard.

107.2 Notice of Correction or Violation. Notices of correction or violation shall be written by the Authority Having Jurisdiction and shall be permitted to be posted at the site of the work, mailed, or delivered to the permittee or their authorized representative.

Refusal, failure, or neglect to comply with such notice or order within 10 days of receipt thereof, shall be considered a violation of this standard and shall be subject to the penalties set forth by the governing laws of the jurisdiction.

107.3 Penalties. A person, firm, or corporation violating a provision of this standard shall be deemed guilty of a misdemeanor, and upon conviction thereof, shall be punishable by a fine, imprisonment, or both set forth by the governing laws of the jurisdiction. Each separate day or portion thereof, during which a violation of this standard occurs or continues, shall be deemed to constitute a separate offense.

107.4 Stop Orders. Where work is being done contrary to the provisions of this standard, the Authority Having Jurisdiction shall be permitted to order the work stopped by notice in writing served on persons engaged in the doing or causing work to be done, and such persons shall forthwith stop work until authorized by the Authority Having Jurisdiction to proceed with the work.

107.5 Authority to Disconnect Utilities in Emergencies. The Authority Having Jurisdiction shall have the authority to disconnect a system and other utilities serving a building, structure, or equipment regulated by this standard in case of an emergency where necessary to eliminate an immediate hazard to life or property.

107.6 Authority to Condemn. Where the Authority Having Jurisdiction ascertains that a urine diversion system, alternate water source system, reclaimed (recycled) water system, stormwater treatment system, rainwater catchment system, or blackwater treatment system or portion thereof, regulated by this standard, has become hazardous to life, health, or property, or has become insanitary, the Authority Having Jurisdiction shall order in writing that such system, either be removed or placed in a safe or sanitary condition. The order shall fix a reasonable time limit for compliance. No person shall use or maintain a defective system after receiving such notice. Where such system is to be disconnected, written notice shall be given. In cases of immediate danger to life or property, such disconnection shall be permitted to be made immediately without such notice.

(renumber remaining sections)

SUBSTANTIATION:

Currently, the WE•Stand is lacking requirements within Chapter 1 (Administration) which address violations and penalties for unlawful construction and use of systems covered by this standard. Specifically, Section 107.6 (Authority to Condemn) is needed to ensure that systems which have become hazardous to life, health, or property, or have become insanitary, are shut down or removed. Additionally, it is useful to specify that systems can be disconnected or shut down in the event of an emergency. The proposed new language strengthens the provisions of the WE•Stand and is also consistent with the layout and provisions of the plumbing code.

COMMITTEE ACTION: ACCEPT AS SUBMITTED

TOTAL ELIGIBLE TO VOTE: 30

VOTING RESULTS: AFFIRMATIVE: 27 NOT RETURNED: 3 CRAWFORD, MCLEOD, WILLIAMS



CODES ADMINISTRATION

Proposals

Item #: 010

WEStand 2023 Section: 108.0 - 108.2

SUBMITTER: Jim Majerowicz
Plumbers Local Union 130 U.A.

RECOMMENDATION:
Add new text

108.0 Board of Appeals.

108.1 General. In order to hear and decide appeals of orders, decisions, or determinations made by the Authority Having Jurisdiction relative to the application and interpretations of this standard, there shall be and is hereby created a Board of Appeals consisting of members who are qualified by experience and training to pass upon matters pertaining to composting toilet, urine diversion system, alternate water source system, reclaimed (recycled) water system, stormwater treatment system, rainwater catchment system, or blackwater treatment system design, construction, and maintenance and the public health aspects of such systems and who are not employees of the jurisdiction. The Authority Having Jurisdiction shall be an ex-officio member and shall act as secretary to said board but shall have no vote upon a matter before the board. The Board of Appeals shall be appointed by the governing body and shall hold office at its pleasure. The board shall adopt rules of procedure for conducting its business and shall render decisions and findings in writing to the appellant with a duplicate copy to the Authority Having Jurisdiction.

108.2 Limitations of Authority. The Board of Appeals shall have no authority relative to interpretation of the administrative provisions of this standard, nor shall the board be empowered to waive requirements of this standard.

SUBSTANTIATION:

Section 108.0 specifies that there must be a Board of Appeals to address and hear appeals on orders and decisions made by the AHJ. This ensures that appeals are reviewed by members who are qualified by experience and training in relevant topics. Limitations for the Board of Appeals are also included to prevent the requirements of the WE•Stand from being waived.

COMMITTEE ACTION: ACCEPT AS SUBMITTED

COMMITTEE STATEMENT:

The Technical Committee would like to note that this language correlates with the Uniform Plumbing Code and provides guidance to jurisdictions without established administrative requirements.

TOTAL ELIGIBLE TO VOTE: 30

VOTING RESULTS: AFFIRMATIVE: 28 NOT RETURNED: 2 CRAWFORD, WILLIAMS



CODES ADMINISTRATION

Proposals

Item #: 011

WEStand 2023 Section: 201.0 - 202.1

SUBMITTER: Jazmin Curiel
Self

RECOMMENDATION:
Revise text

201.0 General.

201.1 Applicability. For the purpose of this standard, the following terms have the meanings indicated in this chapter. No attempt is made to define ordinary words, which are used in accordance with their established dictionary meanings, except where a word has been used loosely and it is necessary to define its meaning as used in this standard to avoid misunderstanding.

~~The definitions of terms are arranged alphabetically according to the first word of the term.~~

202.0 Definition of Terms.

202.1 General. The definitions of terms are arranged alphabetically according to the first word of the term.

SUBSTANTIATION:

The proposed modifications allow for consistency with the Uniform Codes.

COMMITTEE ACTION: ACCEPT AS SUBMITTED

TOTAL ELIGIBLE TO VOTE: 30

VOTING RESULTS: AFFIRMATIVE: 28 NOT RETURNED: 2 CRAWFORD, WILLIAMS



CODES ADMINISTRATION

Proposals

Item #: 012

WEStand 2023 Section: 204.0

SUBMITTER: John S Lansing
PAE Consulting Engineers

RECOMMENDATION:
Add new text

204.0 -B-

Backflow. The flow of water or other liquids, mixtures, or substances into the distributing pipes of a potable supply of water from sources other than the intended source.

Backflow Preventer. A backflow prevention device, an assembly, or another method to prevent backflow into the potable water system.

SUBSTANTIATION:

The terms “backflow” and “backflow preventer” are used throughout the standard, and it would benefit users of the WE•Stand if such terms were defined appropriately. To ensure sure correct terminology is provided, the proposed definitions were gathered from the plumbing code.

COMMITTEE ACTION: ACCEPT AS SUBMITTED

TOTAL ELIGIBLE TO VOTE: 30

VOTING RESULTS: AFFIRMATIVE: 28 NOT RETURNED: 2 CRAWFORD, WILLIAMS



CODES ADMINISTRATION

Proposals

Item #: 013

WEStand 2023 Section: 204.0, 206.0, Chapter 7

SUBMITTER: Pat Lando
Recode

RECOMMENDATION:
Revise text

204.0 - B -

~~**Blackwater.** Waste water containing bodily or other biological wastes discharged from toilets and kitchen sink waste.~~

206.0 - D -

~~**Domestic Sewage.** The liquid and water-borne wastes derived from the ordinary living processes, free from industrial wastes, and of such character as to permit satisfactory disposal, without special treatment, into the public sewer or by means of a private sewage disposal system.~~

CHAPTER 7 ONSITE **BLACKWATER DOMESTIC SEWAGE** TREATMENT SYSTEMS

701.0 General.

701.1 Applicability. The provisions of this chapter shall apply to the water quality, monitoring, design, construction, alteration, repair, and operation requirements of onsite ~~blackwater domestic sewage~~ treatment systems for non-potable reuse.

701.2 Allowable Use of **Blackwater Domestic Sewage.** Where approved or required by the Authority Having Jurisdiction, ~~blackwater domestic sewage~~ shall be permitted to be used in lieu of potable water for uses such as, but not limited, to water closets, urinals, clothes washers, ornamental plant irrigation, and dust suppression.

702.0 System Design.

702.1 Requirements. Onsite ~~blackwater domestic sewage~~ treatment systems shall meet the design, construction, and performance requirements of Section 702.1.1 or 702.1.2.

702.1.1 Listed **Blackwater Domestic Sewage Treatment Systems.** Onsite ~~blackwater domestic sewage~~ treatment systems shall be listed to NSF 350, installed according to the manufacturer's instructions, and commissioned in accordance with Section 703.0.

702.1.2 Alternative Design Systems. Where approved by the Authority Having Jurisdiction, onsite ~~blackwater domestic sewage~~ treatment systems for residential and commercial applications shall comply with the provisions of Sections 702.2 through 705.0.

702.2 Permit. It shall be unlawful for any person to construct, install, alter, or cause to be constructed, installed, or altered any ~~blackwater domestic sewage~~ treatment system in a building or on a premise without first obtaining a permit to do such work from the Authority Having Jurisdiction.

702.4 Material Compatibility. ~~Blackwater Domestic sewage~~ treatment systems shall be constructed of materials that are compatible with the type of pipe and fitting materials, water treatment, and water conditions in the system.

702.5 Log Reduction Targets. ~~Blackwater Domestic sewage~~ treatment systems shall be designed to meet the log reduction targets as set forth in Table 702.5. To meet the log reduction targets in Table 702.5, treatment processes used in ~~blackwater domestic sewage~~ systems shall comply with Section 702.7 for validation or be operated according to conditions approved by the Authority Having Jurisdiction.

TABLE 702.5

**LOG REDUCTION TARGETS FOR 10⁻⁴ INFECTIONS PER PERSON PER YEAR BENCHMARKS FOR
BLACKWATER DOMESTIC SEWAGE TREATMENT SYSTEMS**

(portions of table not shown remains unchanged)

702.6 Effluent Water Quality Parameters. Blackwater Domestic sewage treatment systems shall be designed to meet the effluent water quality parameters for water closet and urinal fixture use listed in Table 702.6.

702.8 Health and Safety. Treated blackwater domestic sewage shall not create a nuisance or odor, nor threaten human health, or damage the quality of surface water or groundwater.

702.9 Monitoring Requirements. Monitoring of blackwater domestic sewage treatment systems shall be based on the risk level in accordance with Table 702.9(1). The parameters listed in Table 702.9(2) shall be monitored by sensors placed in the effluent of the system and connected to a smart controller. The smart controller shall activate an alarm when the parameters in Table 702.9(2) are outside the specifications and shall shut the system down when the alarm is not acknowledged after a period of 8 hours has elapsed. For Category 2, quarterly grab samples shall be taken out of the effluent and analyzed by an accredited lab. The sensors' accuracy and response shall be validated upon commissioning of the system by an independent third party.

702.10 System Requirements. The design and installation of onsite blackwater domestic sewage treatment systems shall meet the requirements of Section 702.10.1 through Section 702.10.6.

702.10.1 Connections to Potable or Reclaimed (Recycled) Water Systems. Blackwater Domestic sewage treatment systems shall have no direct connection to any potable water supply or reclaimed (recycled) water source system. Potable water or reclaimed (recycled) water shall be permitted to be used as makeup water for a blackwater domestic sewage treatment system provided the potable or reclaimed (recycled) water supply connection is protected by an airgap.

702.10.2 Bypass Connection. A bypass shall be provided for the input connection to the blackwater domestic sewage treatment system. The bypass shall be a diverter valve normally open to the blackwater domestic sewage treatment system. The normally closed port of the diverter valve shall be connected directly to the plumbing drainage system according to the plumbing code.

702.10.3 Overflow Connection. Blackwater Domestic sewage treatment overflow shall be connected directly to the plumbing drainage system. The overflow shall be provided with a backwater valve at the point of connection to the plumbing drainage system. The backwater valve shall be accessible for inspection and maintenance.

702.10.4 Fail-safe Mechanisms. Blackwater Domestic sewage treatment systems shall be equipped with an automatic shutdown of the treatment process when a malfunction occurs.

702.10.5 Flow Meter Totalizer. Buildings with blackwater domestic sewage treatment systems shall include a flow meter totalizer on the treated blackwater domestic sewage distribution system and a flow meter totalizer on the potable make-up water connection to the blackwater domestic sewage treatment system.

703.0 Commissioning.

703.1 General. Onsite blackwater domestic sewage treatment systems shall be commissioned in accordance with the requirements of Section 703.1 through Section 703.5.

703.2 Requirements. Commissioning for blackwater domestic sewage treatment systems shall be included in the design and construction processes of the project. Commissioning shall be performed by a person who demonstrates competency in commissioning blackwater domestic sewage treatment systems as required by the Authority Having Jurisdiction.

703.3 Plan. The construction documents shall include the commissioning plan for the blackwater domestic sewage treatment system. The commissioning plan shall be approved by the Authority Having Jurisdiction prior to commissioning the blackwater domestic sewage treatment system. The commissioning plan shall include the following: (1) - (8) (remaining text unchanged)

703.4 Performance Testing. Performance tests shall verify that the installation and operation of the equipment of the blackwater domestic sewage treatment system is in accordance with the approved plans and specifications. The performance test report shall include the equipment tested, the testing methods utilized, and proof of proper calibration of the equipment.

705.0 Inspection. Field inspections shall take place during and after construction while the contractor is on-site to verify that the blackwater domestic sewage treatment system components have been properly supplied and installed according to the plans and specifications used for installation. Record drawings shall be maintained with changes to the approved plans by the contractor and available for periodic inspection as needed.

SUBSTANTIATION:

The term "blackwater" should be removed for several reasons. First the existing definition does not accurately include all of the water sources for these systems. "Blackwater" reuse systems typically use waters from fixtures other than toilets and kitchen sinks, such as showers and lavatories. Second the term is duplicative of the existing definition for "domestic sewage" found in the body of the plumbing code.

As stakeholders work to codify the use of alternate water types, there has been a trend to name and define an increasing number of alternate water types based on both the sources of the water and the contents of the water, including pathogens and organic content. This has led to assigning nebulous, color-based terms such as "blackwater", "graywater", "dark-graywater", "yellow-water", and "brown-water". Many of these terms are commonly used, generally well defined in different codes, however these terms, especially those utilizing various colors, such as graywater (greywater) and blackwater, fail to communicate an adequate level of technical accuracy or a reasonable description of the resource that would allow for a clear public understanding.

More importantly, these terms are not consistent or standardized throughout the nation making this issue increasingly problematic as these systems become more complicated in design and wide-spread in adoption. In addition to the terms "blackwater", "brown-water" and "yellow-water" being inadequately descriptive of the resource, they have potential to reinforce negative stereotypes about people of color. The use of color descriptors for water that is considered a public health risk could be seen as reinforcing a culture where the colors are associated with "bad" versus "good", which runs counter to the fact that all alternate water supplies can be put to beneficial end uses. The establishment of a clear and more appropriate set of water reuse terms and definitions is foundational to all other technical considerations.

Much of this proposal was prepared for the 2019 IAPMO WE•Stand proposals and at the time it was perhaps too forward thinking. Today we find ourselves in a different place where social equity and institutional racism is a forefront idea. IAPMO and the Technical Committee has the opportunity to remove codified language that is inaccurate, duplicative and may appear to support practices of institutionalized racism. As Executive Director of Recode, I have been working on this issue since 2018 with our nation-wide coalition that supported this proposal. Moreover, our support of the 2019 Plumbing Industry Leadership Council request to the US EPA demonstrates the need for leadership in removing these colloquial and potentially damaging terms from our building codes.

[Supporting documentation is provided in KAVI for TC review]

COMMITTEE ACTION: REJECT

COMMITTEE STATEMENT:

The proposed change in terminology is not desired as "blackwater" is common technical industry terminology, and the term "blackwater" is not interchangeable with "domestic sewage" as currently defined. Additionally, this change conflicts with terminologies used in the plumbing code.

The Technical Committee also does not agree with the substantiation provided but believes the intent is beneficial as science-based descriptions for water are available.

Furthermore, additional definitions are required to provide the necessary clarity for distinction between the varying levels of water quality and contaminants which allow for appropriate classifications to be determined.

TOTAL ELIGIBLE TO VOTE: 30

VOTING RESULTS: AFFIRMATIVE: 23 NEGATIVE: 5 NOT RETURNED: 2 CRAWFORD, WILLIAMS

EXPLANATION OF AFFIRMATIVE:

ALLEN: I agree with the need to change the terms, but I am not sure "domestic sewage" is the right word. I look forward to working on finding the best words for all the various waters in the future.

KOELLER: The proposed action is entirely outside of the scope of WE•Stand and was correctly rejected by the committee. The terms being proposed for change have stood for decades and do not warrant reconsideration.

MANN: I agree with John Koeller, and furthermore, as was brought up at the T.C. meeting, should one agree with the change they are agreeing with the substantiation. The substantiation is totally WOKE!!!

PAPE: IAPMO should consider a task group to rename and redefine water categories based up upon a variety of water qualities. "Black" and "gray" are no longer adequate to describe the various water qualities and appropriate uses. The insinuation that these terms are racist is intolerable.

SOVOCOOOL: While I agree that the terminology here and other places needs changing, I think there is risk in doing it in piecemeal fashion in this way. Here "domestic sewage" and other revised terms may cause more problems without comprehensive development and a rollout plan for the industry.

EXPLANATION OF NEGATIVE:

KLEIN: I think that the terminology that exists for different water sources developed in a piecemeal manner, starting with the then common understanding that there was only one water source. We are quickly running out of color choices that are clearly related to the water source. For example, why purple for municipally treated reclaimed water? I think that IAPMO and WE•Stand should form a working group to look into a comprehensive reclassification scheme.

LANDO: The proposal offers a reasonable understanding that color coded language in a plumbing standard is not based in science and/or is appropriate and must be resolved. The proposal identifies a sound, or at least a better solution than the redundant and colloquial nature of terms that exist in the standard.

LANSING: The proposal offers valid points for improving terminology and suggests terms that are primarily consistent with international usage, with some exceptions. I believe a working group should be set up to develop this further.

LENGER: This is a big step in the right direction.

OSANN: The proposal offers a reasonable description of wastewater containing toilet waste, moving away from color coded shorthand.



CODES ADMINISTRATION

Proposals

Item #: 014

WEStand 2023 Section: 204.0, 221.0, Chapter 7

SUBMITTER: Pat Lando
Recode

RECOMMENDATION:
Revise text

204.0 - B -

~~Blackwater. Waste water containing bodily or other biological wastes discharged from toilets and kitchen sink waste.~~

221.0 - S -

~~Sewage. Liquid waste containing animal or vegetable matter in suspension or solution and that may include liquids containing chemicals in solution.~~

CHAPTER 7 ONSITE **BLACKWATER SEWAGE** TREATMENT SYSTEMS

701.0 General.

701.1 Applicability. The provisions of this chapter shall apply to the water quality, monitoring, design, construction, alteration, repair, and operation requirements of onsite **blackwater sewage** treatment systems for non-potable reuse.

701.2 Allowable Use of Blackwater Sewage. Where approved or required by the Authority Having Jurisdiction, **blackwater sewage** shall be permitted to be used in lieu of potable water for uses such as, but not limited, to water closets, urinals, clothes washers, ornamental plant irrigation, and dust suppression.

702.0 System Design.

702.1 Requirements. Onsite **blackwater sewage** treatment systems shall meet the design, construction, and performance requirements of Section 702.1.1 or 702.1.2.

702.1.1 Listed Blackwater Sewage Treatment Systems. Onsite **blackwater sewage** treatment systems shall be listed to NSF 350, installed according to the manufacturer's instructions, and commissioned in accordance with Section 703.0.

702.1.2 Alternative Design Systems. Where approved by the Authority Having Jurisdiction, onsite **blackwater sewage** treatment systems for residential and commercial applications shall comply with the provisions of Sections 702.2 through 705.0.

702.2 Permit. It shall be unlawful for any person to construct, install, alter, or cause to be constructed, installed, or altered any **blackwater sewage** treatment system in a building or on a premise without first obtaining a permit to do such work from the Authority Having Jurisdiction.

702.4 Material Compatibility. **Blackwater Sewage** treatment systems shall be constructed of materials that are compatible with the type of pipe and fitting materials, water treatment, and water conditions in the system.

702.5 Log Reduction Targets. **Blackwater Sewage** treatment systems shall be designed to meet the log reduction targets as set forth in Table 702.5. To meet the log reduction targets in Table 702.5, treatment processes used in **blackwater sewage** systems shall comply with Section 702.7 for validation or be operated according to conditions approved by the Authority Having Jurisdiction.

TABLE 702.5
LOG REDUCTION TARGETS FOR 10⁻⁴ INFECTIONS PER PERSON PER YEAR BENCHMARKS FOR
BLACKWATER SEWAGE TREATMENT SYSTEMS

(portion of table not shown remains unchanged)

702.6 Effluent Water Quality Parameters. Blackwater Sewage treatment systems shall be designed to meet the effluent water quality parameters for water closet and urinal fixture use listed in Table 702.6.

702.8 Health and Safety. Treated blackwater sewage shall not create a nuisance or odor, nor threaten human health, or damage the quality of surface water or groundwater.

702.9 Monitoring Requirements. Monitoring of blackwater sewage treatment systems shall be based on the risk level in accordance with Table 702.9(1). The parameters listed in Table 702.9(2) shall be monitored by sensors placed in the effluent of the system and connected to a smart controller. The smart controller shall activate an alarm when the parameters in Table 702.9(2) are outside the specifications and shall shut the system down when the alarm is not acknowledged after a period of 8 hours has elapsed. For Category 2, quarterly grab samples shall be taken out of the effluent and analyzed by an accredited lab. The sensors' accuracy and response shall be validated upon commissioning of the system by an independent third party.

702.10 System Requirements. The design and installation of onsite blackwater sewage treatment systems shall meet the requirements of Section 702.10.1 through Section 702.10.6.

702.10.1 Connections to Potable or Reclaimed (Recycled) Water Systems. Blackwater Sewage treatment systems shall have no direct connection to any potable water supply or reclaimed (recycled) water source system. Potable water or reclaimed (recycled) water shall be permitted to be used as makeup water for a blackwater sewage treatment system provided the potable or reclaimed (recycled) water supply connection is protected by an airgap.

702.10.2 Bypass Connection. A bypass shall be provided for the input connection to the blackwater sewage treatment system. The bypass shall be a diverter valve normally open to the blackwater sewage treatment system. The normally closed port of the diverter valve shall be connected directly to the plumbing drainage system according to the plumbing code.

702.10.3 Overflow Connection. Blackwater Sewage treatment overflow shall be connected directly to the plumbing drainage system. The overflow shall be provided with a backwater valve at the point of connection to the plumbing drainage system. The backwater valve shall be accessible for inspection and maintenance.

702.10.4 Fail-safe Mechanisms. Blackwater Sewage treatment systems shall be equipped with an automatic shutdown of the treatment process when a malfunction occurs.

702.10.5 Flow Meter Totalizer. Buildings with blackwater sewage treatment systems shall include a flow meter totalizer on the treated blackwater sewage distribution system and a flow meter totalizer on the potable make-up water connection to the blackwater sewage treatment system.

703.0 Commissioning.

703.1 General. Onsite blackwater sewage treatment systems shall be commissioned in accordance with the requirements of Section 703.1 through Section 703.5.

703.2 Requirements. Commissioning for blackwater sewage treatment systems shall be included in the design and construction processes of the project. Commissioning shall be performed by a person who demonstrates competency in commissioning blackwater sewage treatment systems as required by the Authority Having Jurisdiction.

703.3 Plan. The construction documents shall include the commissioning plan for the blackwater sewage treatment system. The commissioning plan shall be approved by the Authority Having Jurisdiction prior to commissioning the blackwater sewage treatment system. The commissioning plan shall include the following:

(1) - (8) (remaining text unchanged)

703.4 Performance Testing. Performance tests shall verify that the installation and operation of the equipment of the blackwater sewage treatment system is in accordance with the approved plans and specifications. The performance test report shall include the equipment tested, the testing methods utilized, and proof of proper calibration of the equipment.

705.0 Inspection. Field inspections shall take place during and after construction while the contractor is on-site to verify that the blackwater sewage treatment system components have been properly supplied and installed according to the plans and specifications used for installation. Record drawings shall be maintained with changes to the approved plans by the contractor and available for periodic inspection as needed.

SUBSTANTIATION:

The term "blackwater" should be removed for several reasons. First the existing definition does not accurately include all of the water sources for these systems. "Blackwater" reuse systems typically use waters from fixtures other than toilets and kitchen sinks, such as showers and lavatories. Second the term is duplicative of the existing definition for "sewage" found in the body of the plumbing code.

As stakeholders work to codify the use of alternate water types, there has been a trend to name and define an increasing number of alternate water types based on both the sources of the water and the contents of the water, including pathogens and organic content. This has led to assigning nebulous, color-based terms such as "blackwater", "graywater", "dark-graywater", "yellow-water", and "brown-water". Many of these terms are commonly used, generally well defined in different codes, however these terms, especially those utilizing various colors, such as graywater (greywater) and blackwater, fail to communicate an adequate level of technical accuracy or a reasonable description of the resource that would allow for a clear public understanding.

More importantly, these terms are not consistent or standardized throughout the nation making this issue increasingly problematic as these systems become more complicated in design and wide-spread in adoption. In addition to the terms "blackwater", "brown-water" and "yellow-water" being inadequately descriptive of the resource, they have potential to reinforce negative stereotypes about people of color. The use of color descriptors for water that is considered a public health risk could be seen as reinforcing a culture where the colors are associated with "bad" versus "good", which runs counter to the fact that all alternate water supplies can be put to beneficial end uses. The establishment of a clear and more appropriate set of water reuse terms and definitions is foundational to all other technical considerations.

Much of this proposal was prepared for the 2019 IAPMO WE•Stand proposals and at the time it was perhaps too forward thinking. Today we find ourselves in a different place where social equity and institutional racism is a forefront idea. IAPMO and the Technical Committee has the opportunity to remove codified language that is inaccurate, duplicative and may appear to support practices of institutionalized racism. As Executive Director of Recode, I have been working on this issue since 2018 with our nation-wide coalition that supported this proposal. Moreover, our support of the 2019 Plumbing Industry Leadership Council request to the US EPA demonstrates the need for leadership in removing these colloquial and potentially damaging terms from our building codes.

[Supporting documentation is provided in KAVI for TC review]

COMMITTEE ACTION: REJECT

COMMITTEE STATEMENT:

The proposed change in terminology is not desired as "blackwater" is common technical industry terminology, and the term "blackwater" is not interchangeable with "sewage" as currently defined. Additionally, this change conflicts with terminologies used in the plumbing code.

The Technical Committee also does not agree with the substantiation provided but believes the intent is beneficial as science-based descriptions for water are available.

Furthermore, additional definitions are required to provide the necessary clarity for distinction between the varying levels of water quality and contaminants which allow for appropriate classifications to be determined.

TOTAL ELIGIBLE TO VOTE: 30

VOTING RESULTS: AFFIRMATIVE: 26 NEGATIVE: 2 NOT RETURNED: 2 CRAWFORD, WILLIAMS

EXPLANATION OF AFFIRMATIVE:

OSANN: The intent of the proposal is appropriate, but the substantiation lacks any description or justification of the actual definition of "sewage" in the proposal.

SOVOCOOL: While I agree that the terminology here and other places needs changing, I think there is risk in doing it in piecemeal fashion in this way. Revised terms may cause more problems without comprehensive development and a rollout plan for the industry.

EXPLANATION OF NEGATIVE:

LANDO: The proposal offers a reasonable understanding that color coded language in a plumbing standard is not based in science and/or is appropriate and must be resolved.* The proposal identifies a sound, or at least a better solution than the redundant and colloquial nature of terms that exist in the standard. (*The substantiation is almost identical to Item #013.)

LANSING: The term "sewage" is appropriate in this application.



CODES ADMINISTRATION

Proposals

Item #: 015

WEStand 2023 Section: 204.0

SUBMITTER: John S Lansing
PAE Consulting Engineers

RECOMMENDATION:
Add new text

204.0 - B -

Building Supply. The pipe carrying potable water from the water meter or another source of water supply to a building or other point of use or distribution onsite.

SUBSTANTIATION:

The proposed definition supports the provisions of the WE-Stand by providing clarity on the term "building supply." This language appropriately defines the term and correlates with the terminology as shown in the plumbing code.

COMMITTEE ACTION: ACCEPT AS SUBMITTED

TOTAL ELIGIBLE TO VOTE: 30

VOTING RESULTS: AFFIRMATIVE: 27 NEGATIVE: 1 NOT RETURNED: 2 CRAWFORD, WILLIAMS

EXPLANATION OF NEGATIVE:

PAPE: I am not certain the definition should be restricted to potable water.



CODES ADMINISTRATION

Proposals

Item #: 016

WEStand 2023 Section: Chapter 2, Chapter 5, Appendix D

SUBMITTER: Markus Lenger
Chair, WE-Stand Urine Diversion Systems & Treatment Task Group

RECOMMENDATION:
Revise text

205.0 - C -

~~Commode~~. ~~The composting toilet fixture for collecting, containing, or transporting excreta to the compost processor.~~
Compost Additives. Any material such as sawdust, wood shavings, and other compostable material added to the ~~commode~~ dry toilet or compost processor to maintain operational conditions within the composting toilet system.

206.0 - D -

Dry Toilet. A fixture for collecting, containing, or transporting excreta, without the use of water. (Also known as commode or site-built toilet.)

222.0 - T -

Transfer. The controlled transfer of excreta or partially processed humus between ~~commode~~ dry toilet and composting processor or between multi-stage composting processors.

223.0 - U -

Urine Diversion. Separation of urine from other excreta that occurs at the ~~commode~~ dry toilet.

504.0 Maintenance and Inspection.

504.2 Operation and Maintenance Manual. An owner's manual shall present clear instructions for maintenance and be transferred to the new owner upon transfer of property or tenancy. The owner's manual shall include:

- (1) – (3) (remaining text unchanged)
- (4) Expected input of and capacity for excreta and compost additives to compost toilet system specifying loading of ~~commode(s)~~ dry toilet(s) and compost processor(s).
- (5) – (9) (remaining text unchanged)

505.0 Composting Toilet System Design.

505.4 ~~Commodes~~ Dry Toilets.

505.4.1 Odor. ~~Commode~~ Dry toilet design or use shall mitigate the infiltration of odors into the building during normal operation and in the event of temporary power failure.

505.4.2 Contact. ~~Commodes~~ Dry toilets shall transport excreta into the compost processor or contain excreta for transfer as designed according to the owner's manual.

505.4.3 Vectors. ~~Commodes~~ Dry toilets shall limit vectors and prevent human contact except for regular maintenance as designed according to the owner's manual.

505.5 Compost Processors. (remaining text unchanged)

505.5.3 Transfer. Where unfinished excreta or diverted urine is transferred between processors or from ~~commode~~ dry toilet to processor, transfer and cleaning of containers and provisions for limiting user exposure shall be according to the owner's manual.

505.5.5 Vermin (Rodent) Proofing. The compost processor shall be protected to prevent the entrance of rodents, vermin, and insects. No unsecured opening other than vents, drainage, or **commode dry toilet** may exceed ½-inch (12 mm) in the least dimension.

505.5.8 Ventilation. Negative ventilation between the **commode dry toilet** and compost processor shall be provided when the compost processor is connected directly to the **commode dry toilet** without a trap. **Commodes Dry toilets** that are not connected to the compost processor do not require a vent.

506.10 Venting. **Commode Dry toilet** fixtures without traps that require ventilation shall be connected to either a dry toilet ventilation stack or a urine diversion ventilation stack. Nonwater urinals used as urine diversion systems shall be connected to a dry toilet ventilation stack or a urine diversion ventilation stack.

**APPENDIX D
COMPOSTING TOILET AND URINE DIVERSION INSPECTION CHECKLIST**

D 201.0 Composting Toilet and Urine Diversion Inspection Checklist. This section includes the inspection checklist form.

Commode Dry Toilet

- If **commode dry toilet** uses repurposed container for transporting excreta into compost processor, container meets third part listing by a listing agency, including US 49 CFR Section 178.274 Specifications for UN Portable Tanks.

Compost Processors

- Compost processors shall have a leachate collection, recirculation, evaporation, or drainage system. See also Leachate Storage Tank checklist.
- Compost processor is rodent proof. No unsecured opening other than vents, drainage, or **commode dry toilet** may exceed ½-inch in the least dimension.
- All composting processors shall be labeled and protected from human contact, surface water and precipitation.
- Compost processor must pass a water tightness test by filling the system to the maximum designed liquid storage capacity of the unit for a duration of 24 hours.
- Where unprocessed excreta or diverted urine is transferred from **commode dry toilet** to processor(s), provide tools and cleaning materials as described in the owner's manual.
- Commodes Dry toilets** connected to compost processor without a trap shall maintain negative ventilation. If compost processor is not connected to the **commode dry toilet** no vent is required.
- Vent stacks terminate at exterior of the building as required by the plumbing or mechanical code.
- The compost processor is sized in accordance with the approved design.

Urine Diversion System

- Material used for urine diversion shall be stainless steel or non-metallic pipe. Concrete piping is prohibited.
- Urine diversion piping is identifiable and labeled. Pipe diameters are sized in accordance with AHJ and the plumbing code.
- Where unprocessed urine is transferred from **commode dry toilet** to processor(s), provide tools and cleaning materials as described in the owner's manual.
- Changes in direction of urine diversion piping shall be made by a long-sweep 90-degree fitting or other approved fittings of equivalent sweep.
- Fixtures discharging into urine diversion piping connected to the plumbing drainage system shall be trapped and vented according to the plumbing code.
- Urine diversion piping is installed at a minimum grade of ½- inch per foot, or 4 percent toward the point of disposal.
- Urine is diverted to a storage tank or an approved plumbing drainage system.
- A maintenance plan shall be included per the design system.

Venting

- ~~Commode~~ Dry toilet fixtures connected directly to compost processor(s) without traps require a ventilation system.
- Nonwater urinals used as urine diversion systems shall be connected to a dry toilet ventilation stack or a urine diversion ventilation stack.

Start up and operation

- Schedule for addition of necessary compost additives.
- Source or provider of necessary compost additives. Source may be on-site.
- Schedule and instructions for all regular maintenance tasks.
- Expected input of and capacity for excreta and compost additives to compost toilet system specifying loading of ~~commode(s)~~ dry toilet(s) and compost processor(s).

(portion of checklist not shown remains unchanged)

SUBSTANTIATION:

The definition for "commode" is a vernacular word that typically describes a fixture in a pit toileting system. Compost toileting systems may use many different types of fixtures that use "toilet" as the basis of its nomenclature. To align with this, "commode" should be replaced with "dry toilet" throughout the WE•Stand. Following the appropriate nomenclature, "toilet," more accurately describes the fixtures that operate without water in compost toileting systems. For these reasons, the proposed modifications are necessary and improve the WE•Stand.

COMMITTEE ACTION: REJECT

COMMITTEE STATEMENT:

The proposal is being rejected as there are commodes which are not entirely "dry." The term "commode" is therefore needed for the enforcement of such installations regarding the limitations of the provisions being applied to other types of applicable toilets.

Additionally, the phrase "transporting excreta" in the provided definition may cause confusion. The Technical Committee recommends the Urine Diversion Systems & Treatment Task Group make the necessary revisions via public comment.

TOTAL ELIGIBLE TO VOTE: 30

VOTING RESULTS: AFFIRMATIVE: 27 NEGATIVE: 1 NOT RETURNED: 2 CRAWFORD, WILLIAMS

EXPLANATION OF NEGATIVE:

LANDO: The "commode" is a colloquial term for the component in a composting/pit toilet system that a person sits on. It typically does not use water. *A commode may or may not be a part of a urine reuse system.

Definitions that are in succession with the plumbing code are:

Toilet

- as approved proposal #016 Dry Toilet
- as approved proposal #078 Urine Diverting Dry Toilet
- as approved proposal #078 Urine Diverting Toilet

*A commode that uses water would be defined as toilet.



CODES ADMINISTRATION

Proposals

Item #: 017

WEStand 2023 Section: 205.0

SUBMITTER: John S Lansing
PAE Consulting Engineers

RECOMMENDATION:
Add new text

205.0 - C -

Construction Documents. Plans, specifications, written, graphic, and pictorial documents prepared or assembled for describing the design, location, and physical characteristics of the elements of a project necessary for obtaining a permit.

SUBSTANTIATION:

The proposed definition clearly indicates what construction documents are to consist of. This provides additional clarity and supports the provisions throughout the standard which require construction documents be submitted to the AHJ for review and approval. Although more detailed specifications are listed in the mandatory body of the document, the proposed definition would also be beneficial for inclusion within Chapter 2 (Definitions). Such language is also consistent with the plumbing code.

COMMITTEE ACTION: ACCEPT AS SUBMITTED

TOTAL ELIGIBLE TO VOTE: 30

VOTING RESULTS: AFFIRMATIVE: 28 NOT RETURNED: 2 CRAWFORD, WILLIAMS



CODES ADMINISTRATION

Proposals

Item #: 018

WEStand 2023 Section: 205.0

SUBMITTER: John S Lansing
PAE Consulting Engineers

RECOMMENDATION:
Add new text

205.0 - C -

Contamination. An impairment of the quality of the potable water that creates hazard to public health through poisoning or the spread of disease by sewage, industrial fluids, waste, or other material that compromises the potable water quality. Also defined as High Hazard.

SUBSTANTIATION:

There are various provisions within the WE•Stand which are in place to prevent contamination of potable water. In support of these provisions, a definition for “contamination” is being proposed. The provided terminology is both clear and appropriate for inclusion. Additionally, the language is similar to the plumbing code.

COMMITTEE ACTION: REJECT

COMMITTEE STATEMENT:

The proposal is unnecessary as the definition is already found in the plumbing code, and the term is only mentioned in Table 802.5. Additionally, “contamination” is a commonly used term which is sufficiently defined in the standard dictionary.

TOTAL ELIGIBLE TO VOTE: 30

VOTING RESULTS: AFFIRMATIVE: 26 NEGATIVE: 2 NOT RETURNED: 2 CRAWFORD, WILLIAMS

EXPLANATION OF AFFIRMATIVE:

KLEIN: I think that “contamination” is a generally understood term. Defining it in WE•Stand is helpful for readers new to the space, but is not essential.

EXPLANATION OF NEGATIVE:

LANSING: Further terminology clarification is warranted, even though the use within the text is currently limited.

LENGER: I am in favor of the additional clarification.



CODES ADMINISTRATION

Proposals

Item #: 019

WEStand 2023 Section: 206.0

SUBMITTER: John S Lansing
PAE Consulting Engineers

RECOMMENDATION:
Add new text

206.0 - D -

Drainage System. Includes all the piping within public or private premises that conveys sewage, storm water, or other liquid wastes to a legal point of disposal, but does not include the mains of a public sewer system or a public sewage treatment or disposal plant.

SUBSTANTIATION:

The proposed definition for "drainage system" is appropriate for addition into the WE•Stand as it supports listed provisions throughout the document. The terminology is inclusive of all the piping within public or private premises that conveys liquid wastes. Such language also correlates with the plumbing code.

COMMITTEE ACTION: ACCEPT AS SUBMITTED

TOTAL ELIGIBLE TO VOTE: 30

VOTING RESULTS: AFFIRMATIVE: 27 NEGATIVE: 1 NOT RETURNED: 2 CRAWFORD, WILLIAMS

EXPLANATION OF AFFIRMATIVE:

KOELLER: Agree with Mr. Thomas Pape's comment. This needs a small editorial change before publishing.

EXPLANATION OF NEGATIVE:

PAPE: Are there premises other than public or private?



CODES ADMINISTRATION

Proposals

Item #: 020

WEStand 2023 Section: 207.0

SUBMITTER: John S Lansing
PAE Consulting Engineers

RECOMMENDATION:
Add new text

207.0 - E -

Effluent. Treated or untreated wastewater typically discharged into surface waters from sewers, treatment plants, or industrial facilities.

SUBSTANTIATION:

The term "effluent" is used throughout Chapter 4, Chapter 7, and Chapter 8 without any current terminology provided in Chapter 2. Without clarification, it may be unclear to the end user as to the type of wastewater these provisions apply to. More specifically, there are water quality requirements that must be followed based on wastewater reuse for water closets and urinal fixtures. The proposed definition also aligns with the US EPA.

COMMITTEE ACTION: REJECT

COMMITTEE STATEMENT:

The provided terminology does not align with the intent of the language used in the WE•Stand which indicates that effluent is treated water.

TOTAL ELIGIBLE TO VOTE: 30

VOTING RESULTS: AFFIRMATIVE: 22 NEGATIVE: 6 NOT RETURNED: 2 CRAWFORD, WILLIAMS

EXPLANATION OF AFFIRMATIVE:

BARNES: I agree with the comment left by the American Supply Association (Jim Kendzel).

KENDZEL: There is a need for a definition for the term "effluent." However, the motion to reject approved by the Committee is appropriate. Proponent or a Committee member could submit a definition that is consistent with the use of the term in the standard.

EXPLANATION OF NEGATIVE:

KLEIN: Effluent needs to be clearly defined in WE•Stand since it is used many times, and in somewhat different contexts. The TC should establish a working group to review the uses of the word and make sure that the rules for an effluent discharge are clearly distinguished from an effluent that, after treatment, becomes a new water source.

KOELLER: If "effluent" is used repeatedly in the document, it should be defined.

LANSING: Adding a definition for "effluent" is useful for further strengthening the WE•Stand document.

LENGER: There is a need to define effluent.

PREMER: "Effluent" needs to be defined in the WE•Stand.

TABAKH: I agree with the other comments provided.



CODES ADMINISTRATION

Proposals

Item #: 021

WEStand 2023 Section: 209.0

SUBMITTER: Jazmin Curiel
Self

RECOMMENDATION:
Add new text

209.0 - G -

Grade. The slope or fall of a line of pipe in reference to a horizontal plane. In drainage, it is usually expressed as the fall in a fraction of an inch (in)_(mm) or percentage slope per foot (ft)_(m) length of pipe.

SUBSTANTIATION:

The term "grade" is used throughout the WE•Stand for provisions pertaining to the installation of storage tanks and horizontal piping. The provided definition is clear and correlates with the plumbing code. Additionally, such language assists users of the standard and provides additional information needed for applying provisions.

COMMITTEE ACTION: REJECT

COMMITTEE STATEMENT:

The proposed definition is correct for plumbing applications but is incorrect as used within the WE•Stand. This adds confusion as to what "grade" vs. "slope" is considered within this document. The term "grade" throughout the WE•Stand provisions is not related to slope, and where grade is specified a slope is provided. In order to mitigate this issue, the Technical Committee recommends that a public comment be submitted which provides this distinction.

TOTAL ELIGIBLE TO VOTE: 30

VOTING RESULTS: AFFIRMATIVE: 28 NOT RETURNED: 2 CRAWFORD, WILLIAMS

EXPLANATION OF AFFIRMATIVE:

LANDO: The term "grade" throughout the WE•Stand provisions is not related to slope but to the land. To mitigate this confusion, a public comment should be submitted which provides this distinction.



CODES ADMINISTRATION

Proposals

Item #: 022

WEStand 2023 Section: Chapter 2, Chapter 6

SUBMITTER: Pat Lando
Recode

RECOMMENDATION:
Revise text

209.0 - G -

Gray Water Sullage. Untreated waste water that has not come into contact with toilet waste, kitchen sink waste, dishwasher waste or similarly contaminated sources. **Gray water Sullage** includes waste water from bathtubs, showers, lavatories, clothes washers and laundry tubs. Also known as **gray water**, grey water, graywater, and greywater.

Gray Water Sullage Diverter Valve. A valve that directs **gray water sullage** to the sanitary drainage system or to a subsurface irrigation system.

203.0 - A -

Alternate Water Source. Nonpotable source of water that includes but not limited to **gray-water sullage**, on-site treated nonpotable water, rainwater, and reclaimed (recycled) water.

206.0 - D -

Disposal Field. An intended destination for **gray-water sullage**, including but not limited to, a mulch basin or receiving landscape feature, **gray-water sullage** leach field, or other approved method of disposal.

215.0 - M -

Mulch. Organic materials, such as wood chips and fines, tree bark chips, and pine needles that are used in a mulch basin to conceal **gray-water sullage** outlets and permit the infiltration of **gray-water sullage**.

Mulch Basin. A subsurface catchment area for **gray-water sullage** that is filled with mulch and of sufficient depth and volume to prevent ponding, surfacing or runoff.

221.0 - S -

Subsoil Irrigation Field. **Gray-water Sullage** irrigation field installed in a trench within the layer of soil below the topsoil. This system is typically used for irrigation of deep rooted plants.

Subsurface Irrigation Field. **Gray-water Sullage** irrigation field installed below finished grade within the topsoil.

Surge Tank. A reservoir to modify the fluctuation in flow rates to allow for uniform distribution of **gray-water sullage** to the points of irrigation.

601.0 General.

601.1 Scope. (remaining text unchanged)

601.1.1 Allowable Use of Alternate Water. Where approved or required by the Authority Having Jurisdiction, alternate water sources (reclaimed (recycled) water, **gray-water sullage** and onsite treated nonpotable water) used in lieu of potable water shall be in accordance with the provisions of this chapter.

601.2 System Design. Alternate water source systems shall be designed in accordance with this chapter by a licensed plumbing contractor, Registered Design Professional, or a person who demonstrates competency to design the alternate water source system as required by the Authority Having Jurisdiction. Components, piping, and fittings used in any alternate water source system shall be listed.

Exceptions:

(1) A person registered or licensed to perform plumbing design work is not required to design **gray-water sullage** systems having a maximum discharge capacity of 250 gallons per day (gal/d) (15.77 L/s) for single family and multi-family dwellings.

(2) (remaining text unchanged)

601.3 Permit. (remaining text unchanged)

601.3.1 Clothes Washer System. A clothes washer system in compliance with all of the following is exempt from the construction permit specified in Section 601.3 and shall be permitted to be installed or altered without a construction permit:

- (1) Where required, notification has been provided to the enforcing agency regarding the proposed location and installation of a **gray-water sullage** irrigation or disposal system.
- (2) The design shall allow the user to direct the flow to the irrigation or disposal field or the building sewer. The direction control of the **gray-water sullage** shall be clearly labeled and readily accessible to the user.
- (3) The installation, change, alteration, or repair of the system does not include a potable water connection or a pump and does not affect other building, plumbing, electrical, or mechanical components including structural features, egress, fire-life safety, sanitation, potable water supply piping, or accessibility. The pump in a clothes washer shall not be considered part of the **gray-water sullage** system.
- (4) The **gray-water sullage** shall be contained on the site where it is generated.
- (5) **Gray-water Sullage** shall be directed to and contained within an irrigation or disposal field.
- (6) (remaining text unchanged)
- (7) **Gray-water Sullage** shall be permitted to be released above the ground surface provided at least 2 inches (51 mm) of mulch, rock, or soil, or a solid shield covers the release point. Other methods which provide equivalent separation are also acceptable.
- (8) **Gray-water Sullage** systems shall be designed to minimize contact with humans and domestic pets.
- (9) (remaining text unchanged)
- (10) **Gray-water Sullage** shall not contain hazardous chemicals derived from activities such as cleaning car parts, washing greasy or oily rags, or disposing of waste solutions from home photo labs or similar hobbyist or home occupational activities.
- (11) Exemption from construction permit requirements of this code shall not be deemed to grant authorization for any **gray-water sullage** system to be installed in a manner that violates other provisions of this code or any other laws or ordinances of the Authority Having Jurisdiction.
- (12) (remaining text unchanged)
- (13) **Gray-water Sullage** discharge from a clothes washer system through a standpipe shall be properly trapped in accordance with the plumbing code.

**TABLE 601.5.1
MINIMUM ALTERNATE WATER SOURCE TESTING, INSPECTION, AND MAINTENANCE FREQUENCY**

DESCRIPTION	MINIMUM FREQUENCY
Inspect and maintain mulch basins for gray-water sullage irrigation systems	As needed to maintain mulch depth and prevent ponding and runoff

(portion of table not shown remains unchanged)

601.5 Maintenance and Inspection. (remaining text unchanged)

601.5.2 Maintenance Log. A maintenance log for **gray-water sullage** and on-site treated nonpotable water systems is required to have a permit in accordance with Section 601.3 and shall be maintained by the property owner and be available for inspection. The property owner or designated appointee shall ensure that a record of testing, inspection and maintenance as required by Table 601.5.1 is maintained in the log. The log will indicate the frequency of inspection and maintenance for each system.

601.6 Operation and Maintenance Manual. An operation and maintenance manual for **gray-water sullage** and on-site treated water systems required to have a permit in accordance with Section 601.3 shall be supplied to the building owner by the system designer. The operating and maintenance manual shall include the following:

(1) – (7) (remaining text unchanged)

601.7 Minimum Water Quality Requirements. The minimum water quality for alternate water source systems shall meet the applicable water quality requirements for the intended application as determined by the Authority Having Jurisdiction. In the absence of water quality requirements for on-site treated nonpotable systems, the water quality requirements of NSF 350 or the EPA/625/R-04/108 shall apply.

Exception: Water treatment is not required for **gray-water sullage** used for subsurface irrigation.

601.11 Inspection and Testing. Alternate water source systems shall be inspected and tested in accordance with Section 601.11.1 and Section 601.11.2.

Exception: Non-pressurized **graywater sullage** or on-site nonpotable water systems without any connection to a potable water system.

601.12 Separation Requirements. All underground alternate water source service piping other than **gray-water sullage** shall be separated from the building sewer in accordance with the plumbing code. Treated nonpotable water pipes run or laid in the same trench as potable water pipes shall have a 12 inch (305 mm) minimum vertical and horizontal separation when both pipe materials are approved for use within a building. Where horizontal piping materials do not meet this requirement the minimum separation shall be increased to 60 inches (1524 mm). The potable water piping shall be installed at an elevation above the treated nonpotable water piping.

602.0 Gray-water Sullage Systems.

602.1 General. The provisions of this section shall apply to the construction, alteration, and repair of **gray-water sullage** systems.

602.2 Gray-water Sullage Collection Piping. New single-family dwellings shall have the a separate waste piping system for all **gray-water sullage** fixtures per the Plumbing Code. The separate piping system shall be piped to outside the building and terminate into an approved **Gray-water sullage** Diverter Valve per Section 602.5 before connecting to the waste system from non-**gray-water sullage** fixtures.

Exception: Where ground conditions do not provide percolation or where prohibited by the Plumbing Code.

602.2.1 Diverter. The diverter valve shall be connected and installed in the open position to the building sewer. The **gray water sullage** diversion port shall remain capped off for future use until a **gray-water sullage** irrigation/reuse system is installed.

602.2.3 Regulatory. **Gray-water Sullage** reuse and irrigation system components shall meet local, and state code and regulatory requirements.

602.3 Discharge. **Gray-water Sullage** diverted away from a sewer or private sewage disposal system of single family and multi-family dwellings, shall discharge to a subsurface irrigation or subsoil irrigation system, or to a mulch basin, or disposal field. **Gray-water Sullage** shall not be used to irrigate root crops or food crops intended for human consumption that come in contact with soil.

602.4 Surge Capacity. **Gray-water Sullage** systems shall be designed to have the capacity to accommodate flow rates entering the system and distribute the total amount of estimated **gray-water sullage** entering the system on a daily basis to a subsurface irrigation field, subsoil irrigation field, or mulch basin without surfacing, ponding, or runoff. A surge tank is required for systems that are unable to accommodate peak flow rates and distribute the total amount of **gray-water sullage** by gravity drainage. The water discharge for **gray-water sullage** systems shall be determined in accordance with Section 602.12.1 or Section 602.12.2. Systems that produce more **gray-water sullage** than needed by the landscape shall discharge excess water into the sewer or private sewage disposal system.

602.5 Diversion. The **gray-water sullage** system shall connect to the sanitary drainage system downstream of fixture traps and vent connections through a diverter valve(s) approved by the Authority Having Jurisdiction. The diverter shall be installed in an accessible location and clearly indicate the direction of flow.

Exception: A clothes washer system in compliance with Section 601.3.1

602.6 Backwater Valves. **Gray-water Sullage** drains subject to backflow shall be provided with a backwater valve so located as to be accessible for inspection and maintenance.

602.7 Connections to Potable and Reclaimed (Recycled) Water Systems. **Gray-water Sullage** systems shall have no direct connection to any potable water supply, on-site treated nonpotable water supply, or reclaimed (recycled) water systems. Potable, on-site treated nonpotable, or reclaimed (recycled) water is permitted to be used as makeup water for a non-pressurized storage tank provided the connection is protected by an airgap in accordance with the plumbing code.

602.8 Location. No **gray-water sullage** system or part thereof shall be located on any lot other than the lot that is the site of the building or structure that discharges the **gray-water sullage**, nor shall any **gray-water sullage** system or part thereof be located at any point having less than the minimum distances indicated in Table 602.8.

TABLE 602.8
LOCATION OF GRAY-WATER SULLAGE SYSTEM

(portion of table not shown remains unchanged)

602.9 Plot Plan Submission. No permit for any **gray-water sullage** system shall be issued until a plot plan with appropriate data satisfactory to the Authority Having Jurisdiction has been submitted and approved.

602.10 Prohibited Location. **Gray-water Sullage** systems are prohibited where there is insufficient lot area or inappropriate soil conditions for adequate absorption to prevent the ponding, surfacing or runoff of the **gray-water sullage**, or on any property in a geologically sensitive area as determined by the Authority Having Jurisdiction.

602.11 Drawings and Specifications. The Authority Having Jurisdiction shall require any or all of the following information to be included with or in the plot plan before a permit is issued for a **gray-water sullage** system, or at any time during the construction thereof:

(1) Plot plan drawn to scale and completely dimensioned, showing lot lines and structures, direction and approximate slope of surface, location of all present or proposed retaining walls, drainage channels, water supply lines, wells, paved

areas and structures on the plot, number of bedrooms and plumbing fixtures in each structure, location of private sewage disposal system and expansion area or building sewer connecting to the public sewer, and location of the proposed **gray-water sullage** system.

(2) – (5) (remaining text unchanged)

602.12 Procedure for Estimating Gray-water Sullage Discharge. **Gray-water Sullage** systems shall be designed to distribute the total amount of estimated **gray-water sullage** on a daily basis. The water discharge for **gray-water sullage** systems shall be determined in accordance with Section 602.12.1 or Section 602.12.2.

602.12.1 Single Family Dwellings and Multi-Family Dwellings. The **gray-water sullage** discharge for single family and multi-family dwellings shall be calculated by water use records, calculations of local daily per person interior water use, or the following procedure:

(1) (remaining text unchanged)

(2) The estimated **gray-water sullage** flows of each occupant shall be calculated as follows:

Showers and bathtubs 13 gallons (50 L) per day/occupant

Lavatories 4 gallons (15 L) per day/occupant

Laundry 10 gallons (38 L) per day/occupant

(3) The total number of occupants shall be multiplied by the applicable estimated **gray-water sullage** discharge as provided above and the type of fixtures connected to the **gray-water sullage** system.

602.12.2 Commercial, Industrial, and Institutional Occupancies. The **gray-water sullage** discharge for commercial, industrial, and institutional occupancies shall be calculated by utilizing the procedure in Section 602.12.1, water use records, or other documentation to estimate **gray-water sullage** discharge.

602.13 Gray-water Sullage System Components. **Gray-water Sullage** system components shall be in accordance with Section 602.13.1 through Section 602.13.7.

602.13.1 Surge Tanks. Where installed, surge tanks shall comply with the following:

(1) (remaining text unchanged)

(2) Each surge tank shall be vented as required by the plumbing code. The vent size shall be determined based on the total **gray-water sullage** fixture units as outlined in the plumbing code.

(3) (remaining text unchanged)

(4) Each surge tank shall have its rated capacity permanently marked on the unit. In addition, a sign stating **GRAY WATER SULLAGE, DANGER — UNSAFE WATER** shall be permanently marked on the holding tank.

(5) – (10) (remaining text unchanged)

602.13.2 Gray-water Sullage Pipe and Fitting Materials. Aboveground and underground building drainage and vent pipe and fittings for **gray-water sullage** systems shall comply with the requirements for aboveground and underground sanitary building drainage and vent pipe and fittings in the plumbing code.

602.13.3 Subsoil Irrigation Field Materials. Subsoil irrigation field piping shall be constructed of perforated high-density polyethylene pipe, perforated ABS pipe, perforated PVC pipe, or other approved materials, provided that sufficient openings are available for distribution of the **gray-water sullage** into the trench area. Material, construction, and perforation of the pipe shall be in compliance with the appropriate absorption field drainage piping standards and shall be approved by the Authority Having Jurisdiction.

602.13.4 Subsurface Irrigation Field and Mulch Basin Supply Line Materials. Materials for **gray-water sullage** piping outside the building for non-pressure gravity systems shall be ABS, polyethylene, PVC or other approved DWV pipe. Pressure systems shall be pressure rated polyethylene or PVC or other approved pressure rated pipe. Drip feeder lines shall be PVC or polyethylene tubing.

602.13.6 Trap. **Gray-water Sullage** piping discharging into the surge tank or having a direct connection to the sanitary drain or sewer piping shall be downstream of an approved water seal type trap(s). If no such trap(s) exists, an approved vented running trap shall be installed upstream of the connection to protect the building from any possible waste or sewer gases.

602.13.7 Backwater Valve. A backwater valve shall be installed on all **gray-water sullage** drain connections to the sanitary drain or sewer.

602.14 Subsurface Irrigation System Zones. Each zone in an irrigation or disposal field having one or more valved zones shall be of adequate size to receive the **gray-water sullage** anticipated in that zone.

602.14.1 Required Area of Subsurface Irrigation Fields, Subsoil Irrigation Fields and Mulch Basins. The minimum effective irrigation area of subsurface irrigation fields, subsoil irrigation fields, and mulch basins shall be determined by Table 602.14.1 for the type of soil found in the excavation, based upon a calculation of estimated **gray-water sullage** discharge pursuant to Section 602.12. For a subsoil irrigation field, the area shall be equal to the aggregate length of the perforated pipe sections within the valved zone multiplied by the width of the proposed subsoil irrigation field.

602.14.2 Determination of Maximum Absorption Capacity. The irrigation field and mulch basin size shall be based on the maximum absorption capacity of the soil and determined using Table 602.14.1. For soils not listed in Table 602.14.1, the maximum absorption capacity for the proposed site shall be determined by percolation tests or other method acceptable to the Authority Having Jurisdiction. A **gray-water sullage** system is prohibited where the percolation test shows the absorption capacity of the soil is unable to accommodate the maximum discharge of the proposed **gray water sullage** irrigation system.

602.14.3 Groundwater Level. No excavation for an irrigation field, disposal field, or mulch basin shall extend within 3 feet (914 mm) vertical of the highest known seasonal groundwater level, nor to a depth where **gray-water sullage** contaminates the groundwater or surface water. The applicant shall supply evidence of groundwater depth to the satisfaction of the Authority Having Jurisdiction.

602.15 Subsurface and Subsoil Irrigation Field, and Mulch Basin Design and Construction. Subsurface and subsoil irrigation field, and mulch basin design and construction shall be in accordance with Section 602.15.1 through Section 602.15.3. Where a **gray-water sullage** irrigation system design is predicated on soil tests, the subsurface or subsoil irrigation field or mulch basin shall be installed at the same location and depth as the tested area.

**TABLE 602.15.1.4
SUBSURFACE IRRIGATION DESIGN CRITERIA FOR SIX TYPICAL SOILS**

TYPE OF SOIL	MAXIMUM EMITTER DISCHARGE	MINIMUM NUMBER OF EMITTERS PER GALLON OF ESTIMATED GRAY WATER SULLAGE DISCHARGE PER DAY*
	gallon/day	gallon/day
Sand	1.8	0.6
Sandy loam	1.4	0.7
Loam	1.2	0.9
Clay loam	0.9	1.1
Silty clay	0.6	1.6
Clay	0.5	2.0

For SI units: 1 gallon per day = 0.000043 L/s

* The estimated **gray-water sullage** discharge per day shall be determined in accordance with Section 602.8.

602.15.1 Subsurface Irrigation Field. (remaining text unchanged)

602.15.1.5 Controls. The system design shall provide user controls, such as valves, switches, timers, and other controllers, to rotate the distribution of **gray-water sullage** between irrigation zones.

602.15.2 Mulch Basin. (remaining text unchanged)

602.15.2.1 Size. Mulch basins shall be of sufficient size to accommodate peak flow rates and distribute the total amount of estimated **gray-water sullage** on a daily basis without surfacing, ponding or runoff. Mulch basins shall have a depth of not less than 10 inches (254 mm) below finished grade. The mulch basin size shall be based on the maximum absorption capacity of the soil and determined using Table 602.14.1.

602.15.2.2 Minimum Depth. **Gray-water Sullage** supply piping, including drip feeders, shall be a minimum 2 inches (51 mm) below finished grade and covered with mulch.

602.16 Gray-water Sullage System Color and Marking Information. Pressurized **gray-water sullage** distribution systems shall be identified as containing nonpotable water in accordance with the plumbing code.

602.18 Testing. Building drains and vents for **gray-water sullage** systems shall be tested in accordance with the plumbing code. Surge tanks shall be filled with water to the overflow line prior to and during inspection. Seams and joints shall be left exposed, and the tank shall remain watertight. A flow test shall be performed through the system to the point of **gray-water sullage** discharge. Lines and components shall be watertight up to the point of the irrigation perforated and drip lines.

602.19 Maintenance. **Gray-water Sullage** systems and components shall be maintained in accordance with Table 601.5.1.

SUBSTANTIATION:

The term "graywater" should be changed throughout the code to "sullage" which was a commonly used 16th English century word defined as "waste from household sinks, showers and baths, but not toilets." -Oxford Dictionary

As stakeholders work to codify the use of alternate water types, there has been a trend to name and define an increasing number of alternate water types based on both the sources of the water and the contents of the water, including pathogens and organic content. This has led to assigning nebulous, color-based terms such as "blackwater", "graywater", "dark-graywater", "yellow-water", and "brown-water". Many of these terms are commonly used and generally well defined in different codes; however these terms, especially those utilizing various colors,

such as graywater (greywater) and blackwater, fail to communicate an adequate level of technical accuracy or a reasonable description of the resource that would allow for a clear public understanding. More importantly, these terms are not consistent or standardized throughout the nation making this issue increasingly problematic as these systems become more complicated in design and wide-spread in adoption.

In addition to the terms “blackwater”, “brown-water” and “yellow-water” being inadequately descriptive of the resource, they have potential to reinforce negative stereotypes about people of color. The use of color descriptors for water that is considered a public health risk could be seen as reinforcing a culture where the colors are associated with “bad” versus “good”, which runs counter to the fact that all alternate water supplies can be put to beneficial end uses.

The establishment of a clear and more appropriate set of Water Reuse terms and definitions is foundational to all other technical considerations. Much of this proposal was prepared for the 2019 IAPMO WE•Stand proposals and at the time it was perhaps too forward thinking. Today we find ourselves in a different place where social equity and institutional racism is a forefront idea. IAPMO and the Technical Committee has the opportunity to remove codified language that is inaccurate, duplicative and may appear to support practices of institutionalized racism. As Executive Director of Recode, I have been working on this issue since 2018 with our nation-wide coalition that supported this proposal. Moreover, our support of the 2019 Plumbing Industry Leadership Council request to the US EPA demonstrates the need for leadership in removing these colloquial and potentially damaging terms from our building codes.

Additional information pertaining to the Water Reuse Action Plan created by the Environmental Protection Agency may be accessed via the following link:

<https://www.regulations.gov/docket/EPA-HQ-OW-2019-0174>

[Supporting documentation is provided in KAVI for TC review]

COMMITTEE ACTION: REJECT

COMMITTEE STATEMENT:

The proposed change in terminology is not desired as “gray water” is common technical industry terminology. Additionally, this change conflicts with terminologies used in the plumbing code.

The Technical Committee also does not agree with the substantiation provided but believes the intent is beneficial as science-based descriptions for water are available.

Furthermore, additional definitions are required to provide the necessary clarity for distinction between the varying levels of water quality and contaminants which allow for appropriate classifications to be determined.

TOTAL ELIGIBLE TO VOTE: 30

VOTING RESULTS: AFFIRMATIVE: 24 NEGATIVE: 4 NOT RETURNED: 2 CRAWFORD, WILLIAMS

EXPLANATION OF AFFIRMATIVE:

KOELLER: The proposed action to redefine a term commonly used in industry is outside of the scope of WE•Stand and was correctly rejected by the committee. The terms being proposed for change have stood for decades and do not warrant reconsideration.

MANN: This was rejected and should stay rejected. The reason statement by the committee is correct. Furthermore, if one accepts the proposal, they are accepting the substantiation and the substantiation is WOKE!!! It does not reflect the thinking of the entire population. If it did, then no one would be white-water rafting.

EXPLANATION OF NEGATIVE:

KLEIN: WE•Stand needs to lead the way with better language even if it runs counter to currently accepted terms.

LANDO: The proposal offers a reasonable understanding that color coded language in a plumbing standard is not based in science and/or is appropriate and must be resolved. The proposal identifies a sound, or at least a better solution than the colloquial nature of term that exists in the WE•Stand. Many state codes have now adopted other

sequential terms such as light and dark gray water, or other spellings such as grey water that further weaken the definition of this resource.

The voting membership, IAMPO and the standards that are published are part of an institution of writing rules and regulations that affect the public. Arguing that this term should remain because it has long-standing industry use is literally the definition of "institutionalized discrimination" and should be refrained from use as a substantiation.

"Institutional discrimination refers to prejudicial practices and policies within institutions that result in the systematic denial of resources and opportunities to members of subordinate groups. This form of discrimination is maintained by the laws, organizational guidelines, or TRADITIONS of an institution."

LANSING: The term "sullage" is an accurate description of these systems and improves on the arbitrary language. The term graywater also has inconsistent use in the US industry and internationally (ex: greywater, grey water, graywater, gray-water, etc.) and standardized terminology reflective of the water quality would be valuable.

LENGER: I agree with Pat Lando's argument.



CODES ADMINISTRATION

Proposals

Item #: 023

WEStand 2023 Section: 209.0

SUBMITTER: Jazmin Curiel
Self

RECOMMENDATION:
Add new text

209.0 - G -

Groundwater. Water that exists beneath the earth's surface.

SUBSTANTIATION:

Since this document addresses excavation limitations and provisions to prevent contamination of groundwater, it is appropriate to include a definition for "groundwater" in Chapter 2. Lastly, similar language was accepted by the UPC Technical Committee for Item #016.

COMMITTEE ACTION: REJECT

COMMITTEE STATEMENT:

The provided terminology is too broad and leads to misinterpretation. Additionally, this language does not provide any benefit to the WE-Stand as presented. There needs to be a distinction where groundwater is considered "water infiltrated within the soil below the earth's surface."

TOTAL ELIGIBLE TO VOTE: 30

VOTING RESULTS: AFFIRMATIVE: 28 NOT RETURNED: 2 CRAWFORD, WILLIAMS

EXPLANATION OF AFFIRMATIVE:

KLEIN: The TC should find other sources that define groundwater and use them as a starting place for a definition that makes sense within the standard.

KOELLER: Not ALL water beneath the 'surface' is normally classified as 'groundwater,' e.g., is potable water inside a buried supply pipe legitimately classified as groundwater? Of course not.



CODES ADMINISTRATION

Proposals

Item #: 024

WEStand 2023 Section: 210.0

SUBMITTER: Jazmin Curiel
Self

RECOMMENDATION:
Add new text

210.0 - H -

Heat Exchanger. A device that transfers heat from one medium to another.

SUBSTANTIATION:

Heat exchangers are addressed in Chapter 10, and providing a simple definition would be beneficial to users of the WE•Stand. In particular, Chapter 10 focuses on conserving water and energy associated with the generation and use of hot water. In order to accomplish this, various requirements aligning with ASHRAE are laid out within the chapter, many of which pertain to heat exchangers. Furthermore, the provided definition is consistent with the plumbing code. For these reasons, the new language is necessary for inclusion.

COMMITTEE ACTION: REJECT

COMMITTEE STATEMENT:

The provided substantiation mentions consistency with the plumbing code. However, the definition for "heat exchanger" does not exist in the plumbing code.

TOTAL ELIGIBLE TO VOTE: 30

VOTING RESULTS: AFFIRMATIVE: 26 NEGATIVE: 2 NOT RETURNED: 2 CRAWFORD, WILLIAMS

EXPLANATION OF AFFIRMATIVE:

KENDZEL: I support the Committee's decision to reject; however, it seems the issue can be easily resolved in public comment by updating the substantiation to reflect text is consistent with the Mechanical Code. A definition for "heat exchanger" is needed since it is used in Chapter 10.

EXPLANATION OF NEGATIVE:

LENGER: "Heat exchanger" needs a definition.

PAPE: The definition is needed despite the flaw in the substantiation.



CODES ADMINISTRATION

Proposals

Item #: 025

WEStand 2023 Section: 214.0

SUBMITTER: Jazmin Curiel
Self

RECOMMENDATION:
Add new text

214.0 - L -

Labeled. Equipment or materials bearing a label of a listing agency (accredited conformity assessment body). See Listed (third-party certified).

SUBSTANTIATION:

Numerous locations within the WE-Stand require products to be "labeled." "Listed (third-party certified)" is currently defined in Chapter 2, and this additional definition provides needed clarity. The terminology also correlates with the plumbing code.

COMMITTEE ACTION: REJECT

COMMITTEE STATEMENT:

The provided definition for "labeled" does not align with each reference to "labeled" within the WE-Stand. The current definition for "Listing (third-party certified)" is sufficient and prevents misinterpretation. There must be a distinction between labeling from a listing agency, and labeling to provide information outside of certification.

TOTAL ELIGIBLE TO VOTE: 30

VOTING RESULTS: AFFIRMATIVE: 28 NOT RETURNED: 2 CRAWFORD, WILLIAMS



CODES ADMINISTRATION

Proposals

Item #: 026

WEStand 2023 Section: 214.0

SUBMITTER: Jazmin Curiel
Self

RECOMMENDATION:
Revise text

214.0 - L -

Lavatory Faucet. A faucet that discharges into a lavatory basin in a domestic or commercial installation.

SUBSTANTIATION:

The proposed minor modification clarifies that the faucet is to discharge to a lavatory basin. Additionally, the language consistent with the plumbing code.

COMMITTEE ACTION: REJECT

COMMITTEE STATEMENT:

The additional language is redundant and unnecessary as a lavatory is already defined as a basin or vessel.

TOTAL ELIGIBLE TO VOTE: 30

VOTING RESULTS: AFFIRMATIVE: 28 NOT RETURNED: 2 CRAWFORD, WILLIAMS



CODES ADMINISTRATION

Proposals

Item #: 027

WEStand 2023 Section: 218.0

SUBMITTER: Billy Smith
Chair, WE-Stand Technical Committee

RECOMMENDATION:
Add new text

218.0 - P -

Plumbing System. Includes all potable water, alternate water sources, building supply, and distribution pipes; all plumbing fixtures and traps; all drainage and vent pipes; and all building drains and building sewers, including their respective joints and connections, devices, receptors, and appurtenances within the property lines of the premises.

SUBSTANTIATION:

The proposed terminology for "plumbing system" is clear and may be valuable to users of the WE-Stand. Such language was derived from the terminology provided in the plumbing code. Additionally, many of the provisions within this standard incorporate the plumbing system and connections to it. For these reasons, the definition is beneficial.

COMMITTEE ACTION: ACCEPT AS SUBMITTED

TOTAL ELIGIBLE TO VOTE: 30

VOTING RESULTS: AFFIRMATIVE: 26 NEGATIVE: 2 NOT RETURNED: 2 CRAWFORD, WILLIAMS

EXPLANATION OF AFFIRMATIVE:

KOELLER: I agree with the comment by Mr. Thomas Pape on this ballot. Minor editorial changes need to be made before publication.

LANDO: Agreed: "There are terms used in this definition that are already defined in Chapter 2; thus, should be italicized."

EXPLANATION OF NEGATIVE:

PAPE: There are terms used in this definition that are already defined in Chapter 2; thus, should be italicized.

PREMER: I agree with the prior comments in terms of editorial change.



CODES ADMINISTRATION

Proposals

Item #: 028

WEStand 2023 Section: 220.0

SUBMITTER: David L. Mann
California State Pipe Trades Council (Retired)

RECOMMENDATION:
Revise text

220.0 - R -

Rainwater. Natural precipitation that lands on a man-made, **impervious** above ground surface and can be collected on-site for beneficial uses.

SUBSTANTIATION:
The definition for "rainwater" is being revised as not all surfaces are impervious. This change is needed as there are surfaces available for the collection of rainwater which are permeable.

COMMITTEE ACTION: ACCEPT AS SUBMITTED

TOTAL ELIGIBLE TO VOTE: 30

VOTING RESULTS: AFFIRMATIVE: 28 NOT RETURNED: 2 CRAWFORD, WILLIAMS



CODES ADMINISTRATION

Proposals

Item #: 029

WEStand 2023 Section: 220.0

SUBMITTER: Billy Smith
Chair, WE-Stand Technical Committee

RECOMMENDATION:
Add new text

220.0 - R -

Rainwater Storage Tank. The central component of the rainwater catchment system. Also known as a cistern or rain barrel.

SUBSTANTIATION:

Rainwater storage tanks are addressed in Chapter 9 (Nonpotable Rainwater Catchment Systems) and in Appendix A (Potable Rainwater Catchment Systems). In both locations, lengthy requirements are listed for construction, location, drainage, overflow, access, marking, and protection. The proposed definition for "rainwater storage tank" supports these requirements and also correlates with the plumbing code. For these reasons, the terminology is necessary for inclusion within Chapter 2 (Definitions).

COMMITTEE ACTION: REJECT

COMMITTEE STATEMENT:

The proposed definition is oversimplified and does not provide a valid description of a "rainwater storage tank." The Technical Committee requests that a more detailed definition be resubmitted via public comment.

TOTAL ELIGIBLE TO VOTE: 30

VOTING RESULTS: AFFIRMATIVE: 28 NOT RETURNED: 2 CRAWFORD, WILLIAMS



CODES ADMINISTRATION

Proposals

Item #: 030

WEStand 2023 Section: 221.0

SUBMITTER: Billy Smith
Chair, WE-Stand Technical Committee

RECOMMENDATION:
Add new text

221.0 - S -

Septic Tank. A watertight receptacle that receives the discharge of a drainage system or part thereof, designed and constructed so as to retain solids, digest organic matter through a period of detention, and allow the liquids to discharge into the soil outside of the tank through a system of open joint piping or a seepage pit.

SUBSTANTIATION:

In certain alternate water source systems, the installation of surge tanks requires that overflow be drained to the existing sewer line or septic tank. Additionally, other requirements pertaining to septic tanks that align with the plumbing code are also provided within this document. To support these provisions, the definition for "septic tank" is being proposed. Furthermore, this terminology provides clarity and correlates with the plumbing code.

COMMITTEE ACTION: REJECT

COMMITTEE STATEMENT:

The proposal is being rejected as the definition for "septic tank" describes a system rather than a type of tank.

TOTAL ELIGIBLE TO VOTE: 30

VOTING RESULTS: AFFIRMATIVE: 28 NOT RETURNED: 2 CRAWFORD, WILLIAMS



CODES ADMINISTRATION

Proposals

Item #: 031

WEStand 2023 Section: 221.0

SUBMITTER: Billy Smith
Chair, WE-Stand Technical Committee

RECOMMENDATION:
Add new text

221.0 - S -

Sewage. Liquid waste containing animal or vegetable matter in suspension or solution and that may include liquids containing chemicals in solution.

SUBSTANTIATION:

Requirements pertaining to sewage cover proper disposal/discharge along with proper connections to the plumbing system. As this standard addresses the optimization of water use while maintaining protection of the public health, safety and welfare, it is necessary to provide all appropriate terminology which may provide clarity for the end user. Furthermore, the proposed language correlates with the plumbing code and supports the requirements of the WE•Stand.

COMMITTEE ACTION: ACCEPT AS SUBMITTED

TOTAL ELIGIBLE TO VOTE: 30

VOTING RESULTS: AFFIRMATIVE: 24 NEGATIVE: 3 ABSTAIN: 1 NOT RETURNED: 2 CRAWFORD, WILLIAMS

EXPLANATION OF NEGATIVE:

KLEIN: A clear definition would be helpful in WE•Stand. The TC should see if there are existing definitions that are applicable. It should also do a review of how sewage is used in each context.

LENGER: I am in favor of the definition.

PAPE: I suggest this definition is too broad. It should contain something to the effect that it is conveyed to an on-site or off-site treatment system.

EXPLANATION OF ABSTAIN:

MCLEOD: Although it does correlate with the UPC, the definitions of water types could use review to align with industry and federal definitions.



CODES ADMINISTRATION

Proposals

Item #: 032

WEStand 2023 Section: 221.0

SUBMITTER: Billy Smith
Chair, WE-Stand Technical Committee

RECOMMENDATION:
Add new text

221.0 - S -

Shall. Indicates a mandatory requirement.

Should. Indicates a recommendation or that which is advised but not required.

SUBSTANTIATION:

The proposed definitions are needed to distinguish between mandatory language and recommendations. Such terminology also correlates with the plumbing code.

COMMITTEE ACTION: ACCEPT AS SUBMITTED

TOTAL ELIGIBLE TO VOTE: 30

VOTING RESULTS: AFFIRMATIVE: 20 NEGATIVE: 7 ABSTAIN: 1 NOT RETURNED: 2 CRAWFORD, WILLIAMS

EXPLANATION OF NEGATIVE:

CUDAHY: No need to define these words.

KLEIN: I don't think there is a need to define either of these words. If we feel it is necessary to explain when "shall" or "should" is used in the standard, we can provide such explanations in the preface.

LANDO: I do not believe that "should" needs to have a definition. It is not a term that imparts a requirement or other technical direction.

LENGER: No need to define "should."

PAPE: I am uncertain that "should" belongs in any text except informative notes.

TABAKH: "Shall" is already defined in a common dictionary to express a mandatory requirement.

WHITE: "Shall" is fine for code language. "Should" does not belong in code language.

EXPLANATION OF ABSTAIN:

SOVOCOOL: Agree with Thomas Pape. We "should" not have this term in the first place.



CODES ADMINISTRATION

Proposals

Item #: 033

WEStand 2023 Section: 221.0

SUBMITTER: Billy Smith
Chair, WE-Stand Technical Committee

RECOMMENDATION:
Add new text

221.0 - S -

Single-Family Dwelling. A building designed to be used as a home by the owner of such building, which shall be the only dwelling located on a parcel of ground with the usual accessory buildings.

SUBSTANTIATION:

When specifying the applicability of provisions, the distinction between dwelling types is clearly stated. Rather than referring to the building code or residential code, it would be best to include a definition for "single-family dwelling" within the WE-Stand. The terminology is also consistent with the plumbing code.

COMMITTEE ACTION: REJECT

COMMITTEE STATEMENT:

The proposed language excludes single-family dwellings serving as rental properties. Additionally, no guidance is provided to address townhomes and other dwellings which typically fall under this classification. Furthermore, the phrase "the only dwelling located on a parcel of ground" is confusing and misleading.

TOTAL ELIGIBLE TO VOTE: 30

VOTING RESULTS: AFFIRMATIVE: 28 NOT RETURNED: 2 CRAWFORD, WILLIAMS



CODES ADMINISTRATION

Proposals

Item #: 034

WEStand 2023 Section: 221.0

SUBMITTER: Robert Pickering
Eastern Research Group, Inc.
EPA WaterSense

RECOMMENDATION:
Revise text

221.0 - S -

Sprinkler Body. The exterior case or shell of a landscape irrigation sprinkler that connects to the piping system and conveys water to a nozzle or orifice.

Sprinkler Head. Landscape irrigation emission device consisting of a sprinkler body and a nozzle discharging water in the form of sprays or rotating streams, not including Low Flow Emitters.

SUBSTANTIATION:
EPA suggests including a definition for sprinkler bodies that meets the intent of ASABE/ICC 802-2020 and the WaterSense Specification for this product category. Inclusion of the definition relates to requirements for spray sprinkler bodies recommended in another proposal.

At the same time, EPA suggests updating the definition of sprinkler heads to be more consistent with the intent of ASABE/ICC 802. In light of EPA's other comments related to criteria for sprinkler bodies, it is important to indicate that the sprinkler body is a component of a sprinkler head.

COMMITTEE ACTION: ACCEPT AS SUBMITTED

TOTAL ELIGIBLE TO VOTE: 30

VOTING RESULTS: AFFIRMATIVE: 28 NOT RETURNED: 2 CRAWFORD, WILLIAMS



CODES ADMINISTRATION

Proposals

Item #: 035

WEStand 2023 Section: 221.0

SUBMITTER: Billy Smith
Chair, WE-Stand Technical Committee

RECOMMENDATION:
Revise text

221.0 - S -

Stormwater. Natural precipitation that has contacted a surface at grade, below grade, or above ground parking surfaces and has not been put to beneficial use.

SUBSTANTIATION:
The definition for "stormwater" is being revised to specify that such water has not been put to beneficial use. This distinction is important since the provisions of the WE•Stand address onsite treatment of stormwater along with its allowable uses. This language is also consistent with the plumbing code.

COMMITTEE ACTION: REJECT

COMMITTEE STATEMENT:
The proposed additional language is unnecessary as "beneficial use" is not defined and may be misinterpreted.

TOTAL ELIGIBLE TO VOTE: 30

VOTING RESULTS: AFFIRMATIVE: 26 NEGATIVE: 2 NOT RETURNED: 2 CRAWFORD, WILLIAMS

EXPLANATION OF NEGATIVE:

LENGER: Seems like a reasonable addition.

PAPE: Most green codes define stormwater as rainwater that has been in contact with pervious surfaces or contaminants of impervious surfaces.



CODES ADMINISTRATION

Proposals

Item #: 036

WEStand 2023 Section: 221.0

SUBMITTER: Billy Smith
Chair, WE-Stand Technical Committee

RECOMMENDATION:
Add new text

221.0 - S -

Sump. An approved tank or pit that receives sewage or liquid waste and which is located below the normal grade of the gravity system and which must be emptied by mechanical means.

SUBSTANTIATION:

An entire section of the WE•Stand is dedicated to sump pumps. Sumps are commonly used to collect leftover contaminants including rainwater, oil, sand, dirt, and wastewater. Once collected and contained, these contaminants can then be disposed of at a later time. The provided definition supports the provisions of the WE•Stand and also correlates with the plumbing code.

COMMITTEE ACTION: REJECT

COMMITTEE STATEMENT:

For the purposes of the WE•Stand, sumps receive groundwater, rainwater, stormwater, and sewage. Therefore, the provided definition does not align with the intent of provisions addressed within this standard. For this reason, the proposal is being rejected.

TOTAL ELIGIBLE TO VOTE: 30

VOTING RESULTS: AFFIRMATIVE: 28 NOT RETURNED: 2 CRAWFORD, WILLIAMS



CODES ADMINISTRATION

Proposals

Item #: 037

WEStand 2023 Section: 225.0

SUBMITTER: Billy Smith
Chair, WE-Stand Technical Committee

RECOMMENDATION:
Delete text without substitution

225.0 - W -

~~**Water Factor (WF).** A measurement and rating of appliance water efficiency, most often used for residential and light commercial clothes washers, as follows:
Clothes Washer (residential and commercial). The quantity of water in gallons used to complete a full wash and rinse cycle per measured cubic foot capacity of the clothes container.~~

SUBSTANTIATION:
The terms are no longer referenced within the WE-Stand and should therefore be removed from Chapter 2 (Definitions).

COMMITTEE ACTION: ACCEPT AS SUBMITTED

TOTAL ELIGIBLE TO VOTE: 30

VOTING RESULTS: AFFIRMATIVE: 28 NOT RETURNED: 2 CRAWFORD, WILLIAMS



CODES ADMINISTRATION

Proposals

Item #: 038

WEStand 2023 Section: 225.0

SUBMITTER: Thomas Pape
Chair, WE-Stand Water Efficient Landscaping Task Group

RECOMMENDATION:
Add new text

225.0 - W -

Water Feature. A landscape element supplied with water for the purposes of maintaining a pool for surface water, excluding a swimming pool or spa.

SUBSTANTIATION:

The term "water feature" is used throughout the standard and does not have an established definition within Chapter 2. For the purposes of providing users of the standard with appropriate terminology, a definition has been added. The language is clear and supports the current provisions of the WE•Stand.

COMMITTEE ACTION: REJECT

COMMITTEE STATEMENT:

The provided definition is incomplete and does not specify applicable landscape elements. Additional clarification is required to appropriately define "water feature."

TOTAL ELIGIBLE TO VOTE: 30

VOTING RESULTS: AFFIRMATIVE: 24 NEGATIVE: 4 NOT RETURNED: 2 CRAWFORD, WILLIAMS

EXPLANATION OF AFFIRMATIVE:

LANSING: Definition excludes other types of water features, such as those that do not use pool water.

SOVOCOL: Agree with committee's rejection. Many water features don't utilize a pooling component. Think features that cascade down rocks, etc. Maybe try, "A landscape element supplied with water for principally ornamental purposes."

EXPLANATION OF NEGATIVE:

KLEIN: Upon further review, I agree that the definition of water feature needs to be revised.

LENGER: "Water feature" needs a definition. I agree with Thomas Pape.

PAPE: "Water feature" needs a definition.

PREMER: "Water feature" needs a definition.



CODES ADMINISTRATION

Proposals

Item #: 039

WESand 2023 Section: 301.0 - 302.2

SUBMITTER: Markus Lenger
CleanBlu Innovations Inc.

RECOMMENDATION:
Revise text

301.0 ~~Scope-General.~~

301.1 ~~Applicability.~~ This chapter covers the general requirements for plumbing and mechanical systems covered by this standard. Such systems shall be in accordance with the requirements of this standard, the plumbing code and the mechanical code.

~~302.0 Approval:~~

~~302.1-301.2~~ **Minimum Standards.** Pipe, pipe fittings, traps, fixtures, material, and devices used ~~in a plumbing system~~ shall be listed (third-party certified) by a listing agency (accredited conformity assessment body) as complying with the approved applicable recognized standards referenced in this standard, and shall be free from defects. Unless otherwise provided for in this standard, materials, fixtures, or devices used or entering into the construction of plumbing systems, or parts thereof, shall be submitted to the Authority Having Jurisdiction for approval prior to being installed.

~~301.2.1~~ **Marking. Each length of pipe and each pipe fitting, material, and device used shall have cast, stamped, or indelibly marked on it any markings required by the applicable referenced standards and listing agency, and the manufacturer's mark or name, which shall readily identify the manufacturer to the end user of the product. Where required by the approved standard that applies, the product shall be marked with the weight and the quality of the product. Materials and devices used or entering into the construction of a system, or parts thereof shall be marked and identified in a manner satisfactory to the Authority Having Jurisdiction. Such marking shall be done by the manufacturer. Field markings shall not be acceptable.**

~~Exception:~~ Markings shall not be required on nipples created from cutting and threading of approved pipe.

~~301.2.2~~ **Standards. Standards listed or referred to in this chapter or other chapters cover materials that will conform to the requirements of this standard, where used in accordance with the limitations imposed in this or other chapters thereof and their listing. Where a referenced standard covers materials of various grades, weights, quality, or configurations, the portion of the listed standard that is applicable shall be used. Design and materials for special conditions or materials not provided for herein shall be permitted to be used by special permission of the Authority Having Jurisdiction after the Authority Having Jurisdiction has been satisfied as to their adequacy. A list of referenced standards that appear in specific sections of this document are referenced in Table 1201.1. Standards referenced in Table 1201.1 shall be applied as indicated in the applicable referenced section.**

~~302.1-4-301.2.3~~ **Plastic Pipe, Plastic Pipe Fittings, and Components. Plastic pipe, plastic pipe fittings, and components other than those for gas shall comply with NSF 14.**

~~301.2.4~~ **Existing Buildings. In existing buildings or premises in which system installations are to be altered, repaired, or renovated, the Authority Having Jurisdiction has discretionary powers to permit deviation from the provisions of this standard, provided that such proposal to deviate is first submitted for proper determination in order that health and safety requirements, as they pertain to the system, shall be observed.**

~~302.2~~ **Mechanical Systems. Mechanical equipment and appliances shall be approved by the Authority Having Jurisdiction or comply with the applicable nationally referenced standards as evidenced by the listing and label of an approved agency.**

(renumber remaining sections)

SUBSTANTIATION:

Section 301.2.1 (Marking) is being proposed as it ensures that piping, fittings, materials and devices are marked by the applicable listing agency and readily identify the manufacturer.

Section 301.2.2 (Standards) addresses the applicability of referenced standards within the WE•Stand and possible imposed limitations.

Section 301.2.4 (Existing Buildings) covers permit deviations for altered, repaired, or renovated existing properties where health and safety requirements are acceptable to the Authority Having Jurisdiction.

The proposed new language and deletion of Section 302.2 is consistent with the plumbing code. Although the WE•Stand is independent of the UPC, it is beneficial to have correlation between the two documents. For these reasons, the revisions are necessary.

COMMITTEE ACTION: REJECT

COMMITTEE STATEMENT:

The proposal is being rejected as the language is redundant and unnecessary. Furthermore, Section 301.2.1 (Marking) is not practical for all pipe lengths.

TOTAL ELIGIBLE TO VOTE: 30

VOTING RESULTS: AFFIRMATIVE: 26 NEGATIVE: 2 NOT RETURNED: 2 CRAWFORD, WILLIAMS

EXPLANATION OF AFFIRMATIVE:

BARNES: I agree with the comment by the American Supply Association (Jim Kendzel).

KENDZEL: The substantiation statement could be improved. As an example, marking requirements are already specified in the product standards. In addition, the standard is already clear as to the use of referenced standards and the extensive text of Section 301.2.2 provides no additional value.

EXPLANATION OF NEGATIVE:

KOELLER: The committee statement for rejection is vague and grossly insufficient, which indicates (to me) that a decision was made in haste.

LENGER: I still think this is needed.



CODES ADMINISTRATION

Proposals

Item #: 040

WEStand 2023 Section: 301.3 - 301.4.6

SUBMITTER: Markus Lenger
CleanBlu Innovations Inc.

RECOMMENDATION:
Revise text

402.0301.3 Alternate Materials, Designs, and Methods of Construction Equivalency.

402.1 General: Nothing in this standard is intended to prevent the use of systems, methods, or devices of equivalent or superior quality, strength, fire resistance, effectiveness, durability, and safety over those prescribed by this standard. Technical documentation shall be submitted to the Authority Having Jurisdiction to demonstrate equivalency. The Authority Having Jurisdiction shall have the authority to approve or disapprove the system, method, or device for the intended purpose.

However, the exercise of this discretionary approval by the Authority Having Jurisdiction shall have no effect beyond the jurisdictional boundaries of said Authority Having Jurisdiction. Any alternate material or method of construction so approved shall not be considered as in accordance with the requirements, intent or both of this standard for any purpose other than that granted by the Authority Having Jurisdiction when the submitted data does not prove equivalency.

301.3.1 Testing. The Authority Having Jurisdiction shall have the authority to require tests, as proof of equivalency. Tests shall be made in accordance with approved or applicable standards, by an approved testing agency at the expense of the applicant. In the absence of such standards, the Authority Having Jurisdiction shall have the authority to specify the test procedure.

301.3.1.1 Requests by Authority Having Jurisdiction. The Authority Having Jurisdiction shall have the authority to require tests to be made or repeated where there is a reason to believe that a material or device no longer is in accordance with the requirements on which its approval was based.

301.4 Alternative Engineered Design. An alternative engineered design shall comply with the intent of the provisions of this standard and shall provide an equivalent level of quality, strength, effectiveness, fire resistance, durability, and safety. Material, equipment, or components shall be designed and installed in accordance with the manufacturer's installation instructions.

301.4.1 Permit Application. The registered design professional shall indicate on the design documents that the system, or parts thereof, is an alternative engineered design so that it is noted on the construction permit application. The permit and permanent permit records shall indicate that an alternative engineered design was part of the approved installation.

301.4.2 Technical Data. The registered design professional shall submit sufficient technical data to substantiate the proposed alternative engineered design and to prove that the performance meets the intent of this standard.

301.4.3 Design Documents. The registered design professional shall provide two complete sets of signed and sealed design documents for the alternative engineered design for submittal to the Authority Having Jurisdiction. The design documents shall include floor plans of the work. Where appropriate, the design documents shall indicate location, sizing, and loading of appurtenances, equipment, appliances, and devices.

301.4.4 Design Approval. An approval of an alternative engineered design shall be at the discretion of the Authority Having Jurisdiction. The exercise of this discretionary approval by the Authority Having Jurisdiction shall have no effect beyond the jurisdictional boundaries of said Authority Having Jurisdiction. An alternative engineered design so approved shall not be considered as in accordance with the requirements, intent, or both of this standard for a purpose other than that granted by the Authority Having Jurisdiction.

301.4.5 Design Review. The Authority Having Jurisdiction shall have the authority to require testing of the alternative engineered design in accordance with Section 301.3.2, including the authority to require an independent review of the design documents by a registered design professional selected by the Authority Having Jurisdiction and at the expense of the applicant.

301.4.6 Inspection and Testing. The alternative engineered design shall be tested and inspected in accordance with the submitted testing and inspection plan and the requirements of this standard.

(renumber remaining sections)

SUBSTANTIATION:

Since there may exist various alternative engineered designs, it is imperative to require such designs to comply with the intent of the provisions of this standard and also provide an equivalent level of quality, strength, effectiveness, fire resistance, durability, and safety.

To further strengthen these requirements, provisions for permit applications, technical data, design documents, approval, review, inspection, and testing have all been provided in the proposed subsections. The proposed language mimics the plumbing code and should also be included in the WE•Stand since both codes are independent.

COMMITTEE ACTION: ACCEPT AS SUBMITTED

TOTAL ELIGIBLE TO VOTE: 30

VOTING RESULTS: AFFIRMATIVE: 28 NOT RETURNED: 2 CRAWFORD, WILLIAMS



CODES ADMINISTRATION

Proposals

Item #: 041

WEStand 2023 Section: 304.0 - 304.1

SUBMITTER: Markus Lenger
CleanBlu Innovations Inc.

RECOMMENDATION:
Add new text

304.0 Damage to Drainage System or Public Sewer.

304.1 Unlawful Practices. It shall be unlawful for a person to deposit, by any means whatsoever, into a plumbing fixture, floor drain, interceptor, sump, receptor, or device, which is connected to a drainage system, public sewer, private sewer, septic tank, or cesspool, any ashes; cinders; solids; rags; inflammable, poisonous, or explosive liquids or gases; oils; grease; or any other foreign object whatsoever that is capable of causing damage to the drainage system or public sewer.

(renumber remaining sections)

SUBSTANTIATION:

Section 304.0 (Damage to Drainage System or Public Sewer) is being proposed to address unlawful practices which may damage the drainage system or public sewer. Since the provisions of the WE•Stand often require connections to the drainage system, such inclusion is necessary. The proposed language is also consistent with the plumbing code.

COMMITTEE ACTION: ACCEPT AS SUBMITTED

TOTAL ELIGIBLE TO VOTE: 30

VOTING RESULTS: AFFIRMATIVE: 28 NOT RETURNED: 2 CRAWFORD, WILLIAMS



CODES ADMINISTRATION

Proposals

Item #: 042

WEStand 2023 Section: 305.0 - 305.2

SUBMITTER: Markus Lenger
CleanBlu Innovations Inc.

RECOMMENDATION:
Add new text

305.0 Industrial Wastes.

305.1 Detrimental Wastes. Wastes detrimental to the public sewer system or detrimental to the functioning of the sewage treatment plant shall be either treated or separated and disposed of, as required by the Authority Having Jurisdiction.

305.2 Safe Discharge. Sewage or other waste from a plumbing system that is capable of being deleterious to surface or subsurface waters shall not be discharged into the ground or a waterway unless it has first been rendered safe by some acceptable form of treatment in accordance with the Authority Having Jurisdiction.

(renumber remaining sections)

SUBSTANTIATION:

Section 305.0 (Industrial Wastes) should be addressed since the WE•Stand contains provisions for industrial processes in Chapter 4, Chapter 6 and Chapter 9. To support such provisions, language should also be provided which covers safe discharge. This language protects the public sewer system as well as surface and subsurface waters.

COMMITTEE ACTION: ACCEPT AS SUBMITTED

TOTAL ELIGIBLE TO VOTE: 30

VOTING RESULTS: AFFIRMATIVE: 28 NOT RETURNED: 2 CRAWFORD, WILLIAMS



CODES ADMINISTRATION

Proposals

Item #: 043

WEStand 2023 Section: 306.0 - 306.2

SUBMITTER: Markus Lenger
CleanBlu Innovations Inc.

RECOMMENDATION:
Add new text

306.0 Workmanship.

306.1 Engineering Practices. Design, construction, and workmanship shall comply with accepted engineering practices and shall be of such character as to secure the results sought to be obtained by this standard.

306.2 Concealing Imperfections. It is unlawful to conceal cracks, holes, or other imperfections in materials by welding, brazing, or soldering or by using therein or thereon a paint, wax, tar, solvent cement, or other leak-sealing or repair agent.

(renumber remaining sections)

SUBSTANTIATION:

Section 306.0 (Workmanship) is being added to ensure that ethical engineering practices are upheld. The proposed language is also consistent with the plumbing code.

COMMITTEE ACTION: ACCEPT AS SUBMITTED

TOTAL ELIGIBLE TO VOTE: 30

VOTING RESULTS: AFFIRMATIVE: 28 NOT RETURNED: 2 CRAWFORD, WILLIAMS



CODES ADMINISTRATION

Proposals

Item #: 044

WEStand 2023 Section: 308.0 - 308.1.4, Table 308.1.2

SUBMITTER: Markus Lenger
CleanBlu Innovations Inc.

RECOMMENDATION:
Add new text

308.0 Identification of a Potable and Nonpotable Water System.

308.1 General. In buildings where potable water and nonpotable water systems are installed, each system shall be clearly identified in accordance with Section 308.1.1 through Section 308.1.4.

308.1.1 Potable Water. Potable water systems shall be labeled using a green background with white lettering.

308.1.2 Color and Information. Each system shall be identified with a colored pipe or band and coded with paints, wraps, and materials compatible with the piping. Except as required by Section 308.1.3, nonpotable water systems shall have a yellow background with black uppercase lettering, with the words: "CAUTION: NONPOTABLE WATER, DO NOT DRINK." Each nonpotable system shall be identified to designate the liquid being conveyed, and the direction of normal flow shall be clearly shown. The minimum size of the letters and length of the color field shall comply with Table 308.1.2. The background color and required information shall be indicated every 20 feet (6096 mm) but not less than once per room, and shall be visible from the floor level.

**TABLE 308.1.2
MINIMUM LENGTH OF COLOR FIELD AND SIZE OF LETTERS**

OUTSIDE DIAMETER OF PIPE OR COVERING (inches)	MINIMUM LENGTH OF COLOR FIELD (inches)	MINIMUM SIZE OF LETTERS (inches)
$\frac{1}{2}$ to $1\frac{1}{4}$	8	$\frac{1}{2}$
$1\frac{1}{2}$ to 2	8	$\frac{3}{4}$
$2\frac{1}{2}$ to 6	12	$1\frac{1}{4}$
8 to 10	24	$2\frac{1}{2}$
Over 10	32	$3\frac{1}{2}$

For SI units: 1 inch = 25.4 mm

308.1.3 Alternate Water Sources. Alternate water source systems shall have a purple (Pantone color No. 512, 522C, or equivalent) background with uppercase lettering and shall be field or factory marked as follows:

(1) Gray water systems shall be marked in accordance with this section with the words:

"CAUTION: NONPOTABLE GRAY WATER, DO NOT DRINK" in black letters.

(2) Reclaimed (recycled) water systems shall be marked in accordance with this section with the words:

"CAUTION: NONPOTABLE RECLAIMED (RECYCLED) WATER, DO NOT DRINK" in black letters.

(3) Onsite treated water systems shall be marked in accordance with this section with the words:

"CAUTION: ONSITE TREATED NONPOTABLE WATER, DO NOT DRINK" in black letters.

(4) Rainwater catchment systems shall be marked in accordance with this section with the words:

"CAUTION: NONPOTABLE RAINWATER, DO NOT DRINK" in black letters.

308.1.4 Outlets. Each outlet on the nonpotable water line that is used for special purposes shall be posted with black uppercase lettering as follows:

"CAUTION: NONPOTABLE WATER, DO NOT DRINK."

SUBSTANTIATION:

Section 308.0 provides the necessary requirements for identifying both potable and nonpotable water systems. To ensure clear requirements are provided, Table 308.1.2 has been included to address the required minimum letter size and length of color fields dependent on pipe diameters. Section 308.1.2 also requires that information be displayed every 20 feet and at least once per room.

Furthermore, Section 308.1.3 specifies the identification requirements for alternate water source systems which is needed to promote health and safety. Including such language in Chapter 3 (General Regulations) is the best location for these requirements. The proposed language is also consistent with the plumbing code.

COMMITTEE ACTION: ACCEPT AS SUBMITTED

TOTAL ELIGIBLE TO VOTE: 30

VOTING RESULTS: AFFIRMATIVE: 28 NOT RETURNED: 2 CRAWFORD, WILLIAMS



CODES ADMINISTRATION

Proposals

Item #: 045

WESand 2023 Section: Table 402.1, Table 1201.1

SUBMITTER: Robert Pickering
Eastern Research Group, Inc.
EPA WaterSense

RECOMMENDATION:
Revise text

**TABLE 402.1
MAXIMUM FIXTURE AND FIXTURE FITTINGS FLOW RATES**

FIXTURE TYPE	FLOW RATE
Showerheads ⁵	2.0 gpm @ 80 psi ¹
Kitchen faucets residential ⁴	1.8 gpm @ 60 psi
Lavatory faucets residential ⁶	1.5 gpm @ 60 psi
Lavatory faucets other than residential	0.5 gpm @ 60 psi
Metering faucets	0.25 gallons/cycle
Metering faucets for wash fountains	One (1) 0.25 gal per cycle fixture fitting for each 20 inches rim space
Wash fountains	One (1) 2.2 gpm @ 60 psi fixture fitting for each 20 inches rim space
Water Closets	1.28 gallons/flush ²
Urinals	0.5 gallons/flush ³
Commercial Pre-Rinse Spray Valves	1.3 gpm @ 60 psi

For SI units: 1 inch = 25.4 mm, 1 gallon = 3.785 L, 1 gallon per minute = 0.06 L/s, 1 pound-force per square inch = 6.8947 kPa

Notes:

¹ For multiple showerheads serving one shower compartment see Section 402.6.1

² Shall also be listed to either EPA WaterSense Specification for Tank-Type Toilets or EPA WaterSense Specification for Flushometer-Valve Water Closets.

³ Shall also be listed to EPA WaterSense Specification for Flushing Urinals. Nonwater urinals shall meet the specifications listed in Section 402.3.1.

⁴ See Section 402.4.

⁵ Shall also be listed to EPA WaterSense Specification for Showerheads.

⁶ Shall also be listed to EPA WaterSense High-Efficiency Lavatory Faucet Specification.

**TABLE 1201.1
REFERENCED STANDARDS**

STANDARD NUMBER-YEAR	STANDARD TITLE	REFERENCED SECTION
EPA WaterSense-2007	High-Efficiency Lavatory Faucet Specification, Version 1.0	402.5.1, <u>Table 402.1</u>

(portion of table not shown remains unchanged)

Note: The EPA WaterSense Specifications meet the requirements for mandatory referenced standards in accordance with Section 15.0 of IAPMO's Regulations Governing Consensus Development of the Water Efficiency and Sanitation Standard.

(Below sections are shown for information purposes only)

402.2.1 Gravity, Pressure Assisted and Electro-Hydraulic Tank Type Water Closets. Gravity, pressure assisted, and electro-hydraulic tank type water closets shall have a maximum effective flush volume of not more than 1.28 gallons (4.8 Lpf) of water per flush in accordance with ASME A112.19.2/CSA B45.1 or ASME A112.19.14 and shall also be listed to the EPA WaterSense Specification for Tank-Type Toilets. The effective flush volume for dual-flush toilets is defined as the composite, average flush volume of two reduced flushes and one full flush.

402.2.2 Flushometer-Valve Activated Water Closets. Flushometer-valve activated water closets shall have a maximum flush volume of not more than 1.28 gallons (4.8 L) of water per flush in accordance with ASME A112.19.2/CSA B45.1 and shall be listed to the EPA WaterSense Specification for Flushometer-Valve Water Closets.

402.5.1 Lavatory Faucets in Residences, Apartments, and Private Bathrooms in Lodging Facilities, Hospitals, and Patient Care Facilities. The flow rate for lavatory faucets installed in residences, apartments, and private bathrooms in lodging, hospitals, and patient care facilities (including skilled nursing and long-term care facilities) shall not exceed 1.5 gpm (5.7 L/m) at 60 psi (414 kPa) in accordance with ASME A112.18.1/CSA B125.1 and shall be listed to the U.S. EPA WaterSense High-Efficiency Lavatory Faucet Specification.

402.6 Showerheads. Showerheads shall not exceed a flow rate of 2.0 gpm (7.6 L/m) at 80 psi (552 kPa) and shall be listed to ASME A112.18.1/CSA B125.1 and the EPA WaterSense Specification for Showerheads.

SUBSTANTIATION:

Footnote 2 is being updated to align with different requirements for gravity versus flushometer-valve activated water closets, as described in Section 402.2.1 and Section 402.2.2.

Footnote 5 aligns with requirements specified within Section 402.6, and Footnote 6 aligns with Section 402.5.1. Both are consistent with the other footnotes which currently exist for Table 402.1.

Additionally, Table 1201.1 is being updated to remove the version number for the specification shown. This revision is consistent with the list of EPA Specifications within Table 1201.1 which do not include the version number. As new versions are published over time, it is better suited to include the publication year.

COMMITTEE ACTION: REJECT

COMMITTEE STATEMENT:

The notes accompanying Table 402.1 include requirements which are already addressed in other sections of the WE•Stand. There is concern that updates to those sections may not be carried over to the notes of Table 402.1 in future editions of the standard. As a means to prevent future conflict and to avoid repeated provisions, the proposal is being rejected.

TOTAL ELIGIBLE TO VOTE: 30

VOTING RESULTS: AFFIRMATIVE: 20 NEGATIVE: 7 ABSTAIN: 1 NOT RETURNED: 2 CRAWFORD, WILLIAMS

EXPLANATION OF NEGATIVE:

CUDAHY: I concur with John Koeller.

KLEIN: I concur with John Koeller. I would also suggest that to remedy the situation the TC should ask the IAPMO secretariat for WE•Stand prepare a note for the next TC to remind them to look at all sections that refer to Water Sense to ensure that the clauses in WE•Stand are up-to-date.

KOELLER: Proposal to clarify and update WaterSense specifications and applications is essential to the effectiveness of WE•Stand. The rejection by the committee over a footnote was unwarranted.

LANSING: I concur with John Koeller.

LENGER: I concur with John Koeller.

PREMER: I am in agreement with Mr. John Koeller.

TABAKH: I concur with John Koeller's comments.

EXPLANATION OF ABSTAIN:

MCLEOD: We support the intent to update the references to include WaterSense. Regarding the details of the footnote, perhaps as Gary Klein has suggested, this is better suited for discussion with the Secretariat.



CODES ADMINISTRATION

Proposals

Item #: 046

WESand 2023 Section: 402.7

SUBMITTER: Kyle Thompson
Plumbing Manufacturers International (PMI)

RECOMMENDATION:
Revise text

402.0 Water-Conserving Plumbing Fixtures and Fittings.

402.7 Bath and Shower Diverters. Tub spout bath and shower diverters, while operating in the shower mode, shall ~~perform with zero leakage~~ have a maximum leakage rate of 0.01 gpm (0.04 L/min) when tested in accordance with ASME A112.18.1/CSA B125.1.

Note: ASME A112.18.1/CSA B125.1 meets the requirements for a mandatory referenced standard in accordance with Section 15.0 of IAPMO's Regulations Governing Consensus Development of the Water Efficiency and Sanitation Standard.

SUBSTANTIATION:

As written, the existing code section does nothing to prevent unnecessary leakages of a diverter. If a diverter is going to leak, it will occur over the lifetime use of the diverter and not during the installation when inspected by the AHJ. What is important is that the diverter meets the performance requirements of ASME A112.18.1/CSA B125.1 which are addressed in Section 5.3.6 of the standard. Testing the rate of leakage is intended to be conducted in a laboratory and not in the field, where the accuracy of such testing can be jeopardized. The maximum leakage rate of 0.01 gpm for tub spout diverters is currently specified in Table H-3 of 20 CCR § 1605.3.

20 CCR § 1605.3 State Standards for Non-Federally-Regulated Appliances may be accessed via the following link:
[https://govt.westlaw.com/calregs/Document/IEEDE2D64EF7B4F168C0E85379828A8C2?viewType=FullText&originationContext=documenttoc&transitionType=CategoryPageItem&contextData=\(sc.Default\)&bhcp=1](https://govt.westlaw.com/calregs/Document/IEEDE2D64EF7B4F168C0E85379828A8C2?viewType=FullText&originationContext=documenttoc&transitionType=CategoryPageItem&contextData=(sc.Default)&bhcp=1)

COMMITTEE ACTION: ACCEPT AS SUBMITTED

TOTAL ELIGIBLE TO VOTE: 30

VOTING RESULTS: AFFIRMATIVE: 17 NEGATIVE: 11 NOT RETURNED: 2 CRAWFORD, WILLIAMS

Note: Item # 046 failed to achieve the necessary two-thirds affirmative vote of returned ballots. In accordance with Section 6.8.2 of the Regulations Governing Consensus Development of the Water Efficiency and Sanitation Standard, a public comment is requested for this proposal. The Technical Committee will reconsider this proposal as a public comment.

EXPLANATION OF AFFIRMATIVE:

CUDAHY: Zero leakage is not achievable.

KENDZEL: Referencing the existing national consensus standard for bath and shower diverters is appropriate and using a technically sound and correct leakage test referenced in the ASME standard is also appropriate. Indicating a "zero leakage" without referencing a means to test and a verifiable measurement provides no sound mandate. I do not see the referencing of the product national standard requirement as weakening the standard; it provides a requirement that is easily validated and tested during the certification/listing process.

MANN: There is an existing standard for testing and that should be used. The inspector may or may not pull up the spout diverter to find out if it leaks or not. The product may have zero leakage when tested but will never remain at zero. They are mechanical devices and will fail over time.

THOMPSON: The existing text in this section specifies a performance requirement of "zero leakage" without providing a means by which a product can demonstrate such performance. The value zero is not possible to measure with existing technology since measurement devices have an inherent limit of resolution and there are no state or federal standards upon which a manufacturer can test or certify that their diverters are truly "zero leakage."

This proposed revision addresses these limitations by including a small maximum leakage rate and a reference to the test method for verification. The standard ASME A112.18.1/CSA B125.1 specifies how a manufacturer is to test these products and Section 5.3.6 includes a leakage rate test. As noted in the proposal substantiation, the maximum leakage rate in the California Code of Regulations is 0.01 gpm for tub spout diverters which is specified in Table H-3 of 20 CCR § 1605.3.

EXPLANATION OF NEGATIVE:

ALLEN: I agree with Edward Osann and Thomas Pape. We should not weaken this standard.

KLEIN: WE•Stand needs to lead the way. Zero leakage is obtainable, and we should not weaken the standard.

KOELLER: What the proponent of this proposal is attempting to do is change a provision that was debated extensively and voted upon in the previous round of WE•Stand several years ago. The "substantiation" offered here by the proponent is exactly what justifies its rejection. OF COURSE, the current provisions in WE•Stand do not "prevent" leakage in the future. JUST AS a showerhead flow rate limitation requirement doesn't prevent a higher flow in that showerhead in the future, or a faucet or toilet, for that matter. What WE•Stand has provided for (and the proponent of this modification is attempting to overturn) is a specified performance WHEN NEW! That is all such a specification can provide!

Furthermore, there is NO NEED to test a diverter in the "field" as the proponent inaccurately describes. The California Energy Commission already qualifies products through an independent testing process by accredited laboratories that results in a LISTING (just as is done for numerous other plumbing products). As such, the "substantiation" is irrelevant and does not fit the 'real world' situation with today's diverters, their testing, their listing, and their application as a water use efficiency provision. To provide further clarification on Mr. Markus Lenger's comment, zero leakage not only "should be" achievable but, in fact, IS achievable and has been so for many years. In fact, in 2015, there were 360 different diverter models in the CEC listings that were "zero leakage." Undoubtedly, there are many more today.

LANDO: I agree with the comments of the other negative votes and the proposals weakening of the WE•Stand. This proposal was debated extensively in previous WE•Stand additions where it was rejected. It continues to be brought forward and rejected over its merits.

LAYTON: We should not settle for minimal leakage just because we have a standard to test for the leakage.

LENGER: Zero leakage should be achievable.

OSANN: This proposal is an unjustified weakening of WE•Stand. Manufacturers have provided test data to the California Energy Commission on over 10,000 models of tub spout diverters (TSDs), and over 60% of these models are listed at zero leakage. "Zero" leakage is actually far easier to verify in field inspection than trying to measure the fraction of a gallon per minute that the proposal would offer as a replacement. I agree that even more savings could come from an improved durability standard for TSDs, and invite the proponent to join in efforts to strengthen this part of the standard, rather than weakening the zero leakage at installation requirement in WE•Stand.

PAPE: There is ample technology available in the marketplace to have zero leakage. It is confounding that WE•Stand allows products included, known to leak at day one. This is a stretch code not the UPC, for cripes sake, we should not bend our goals to appease a manufacturer.

PREMER: Allowing leakage is not in congruence with WE•Stand goals.

SOVOCOOL: Agree with Commenters. Going further, having an inspector finding a leaking diverter valve in a WE•Stand installation hurts the credibility of the standard. Even worse? The customer finding it.

WHITE: This has been highly debated and continues to show up. As a stretch code, it should be acceptable to go beyond the minimum requirements.



CODES ADMINISTRATION

Proposals

Item #: 047

WESStand 2023 Section: 402.8.1

SUBMITTER: Kyle Thompson
Plumbing Manufacturers International (PMI)

RECOMMENDATION:
Delete text without substitution

402.0 Water-Conserving Plumbing Fixtures and Fittings.

402.8 Shower Valves. Shower valves shall meet the temperature control performance requirements of ASSE 1016/ASME A112.1016/CSA B125.16 when tested for the rated flow rate of the installed showerhead.

~~402.8.1 Marking. Control valves for showers and tub-shower combinations shall be tagged, labeled, or marked with the manufacturer's minimum rated flow and such marking shall be visible after installation.~~

(Section 402.8 is shown for information purposes only)

SUBSTANTIATION:

Marking requirements are already addressed in the applicable product standards (ex: ASSE 1016/ASME A112.1016/CSA B125.16 – Section V) and do not belong in the code. Therefore, such provisions should be vetted first through the appropriate standard development committee. In addition, such requirements for tags, labels, and markings are unnecessary as this information is generally available on the manufacturer's website.

The requirement in the code is unclear as to what is meant by visible after installation. Whether that means after the control valve is installed, or after the finishing trim of the shower is installed, the language is unclear. Markings on escutcheons or other trim components are not possible in all applications as these parts are used on a multitude of different products. Research conducted by manufacturers has determined that a majority of consumers desire a minimal number of markings on escutcheons or other trim components. Which effectively means that any such temporary tag, label, or marking will most likely be removed by the consumer before a new showerhead is installed.

COMMITTEE ACTION: REJECT

COMMITTEE STATEMENT:

Section 402.8.1 (Marking) is needed as such requirements are not directly covered within the ASSE 1016/ASME A112.1016/CSA B125.16 standard.

Without disassembling a unit, the rated flow for the mixing valve and thermal protection should be known. The showerhead selected for future installation may not be compatible with the thermal protection of the system.

Valves tested with showerheads have a minimum flow rate approved for safe use. Information on rated flow is difficult to find and often must be sourced by contacting the manufacturer. Showerheads are one of the most frequently changed fixtures, and such language must be readily available to ensure compatibility and safe operation. If this language is removed, it poses as a health and safety hazard for users and consumers.

TOTAL ELIGIBLE TO VOTE: 30

VOTING RESULTS: AFFIRMATIVE: 17 NEGATIVE: 11 NOT RETURNED: 2 CRAWFORD, WILLIAMS

Note: Item # 047 failed to achieve the necessary two-thirds affirmative vote of returned ballots. In accordance with Section 6.8.2 of the Regulations Governing Consensus Development of the Water Efficiency and Sanitation Standard, a public comment is requested for this proposal. The Technical Committee will reconsider this proposal as a public comment.

EXPLANATION OF NEGATIVE:

BARNES: I agree with the original substantiation provided by PMI. The current language regarding marking is not enforceable and should be removed from this section. The applicable product standards address marking requirements; these standards should be reconsidered before adding additional marking requirements in WE•Stand.

CUDAHY: The language is not enforceable and is unclear.

GRANGER: The language is unclear and not enforceable.

KENDZEL: I do not believe the current language is enforceable and is also not practical for applying at the point of manufacture or in the field. Although I agree with the intent behind the current wording, I think further discussions are required to come up with a workable solution which I am in the process of completing. Until a workable solution is developed, the current text should be deleted from the standard.

LAYTON: Products are required to be manufactured to ASSE 1016/ASME A112.1016/CSA B125.16 requirements. Adding this language to WE•Stand is not enforceable.

MANN: After further review, I am trying to figure out what the purpose is of this requirement. The valve and shower head generally come as a kit. If one is trying to protect the end user (homeowner), forget that. They will not understand what this marking means. This is overly restrictive to our manufacturing industries' costs for something that the installer already knows, and the end user has no clue.

MCLEOD: The language is not enforceable and is unclear. Additionally, markings on escutcheons or other trim components are not possible in all applications as these parts are used on a multitude of different products.

PREMER: I am in agreement with Cambria McLeod's comment.

SEWELL: The language is not enforceable and is unclear. Additionally, markings on escutcheons or other trim components are not possible in all applications.

SMITH: I agree with Cambria McLeod as written here: "The language is not enforceable and is unclear. Additionally, markings on escutcheons or other trim components are not possible in all applications as these parts are used on a multitude of different products."

THOMPSON: The existing language is unenforceable. Tags or labels as currently required are likely be discarded before the device is installed. Compliance with ASSE 1016 requires identification markings on the device and the minimum flow rates to be included on the product packaging or literature and if needed for future replacement an installer can track down the information through the products identification markings.



CODES ADMINISTRATION

Proposals

Item #: 048

WEStand 2023 Section: 402.9 - 402.12, Table 402.11, Table 1201.1

SUBMITTER: Billy Smith
Chair, WE-Stand Technical Committee

RECOMMENDATION:
Revise text

402.0 Water-Conserving Plumbing Fixtures and Fittings.

~~402.12~~**402.9 Recirculating Shower Systems.** (remaining text unchanged)

402.10 Bath and Shower Flow-Reduction Devices. Bath and shower flow-reduction devices shall comply with IAPMO IGC 244.

~~402.9~~**402.11 Commercial Pre-Rinse Spray Valves.** The flow rate for a pre-rinse spray valve installed in a commercial kitchen to remove food waste from cookware and dishes prior to cleaning shall not be more than ~~1.28 gpm (4.8 L/m) at 60 psi (414 kPa) the maximum flow rate, as specified in Table 402.11.~~ Where pre-rinse spray valves with maximum flow rates of 1.0 gpm (3.8 L/m) or less are installed, the static pressure shall be not less than 30 psi (207 kPa). Commercial kitchen pre-rinse spray valves shall be equipped with an integral automatic shutoff.

(renumber remaining sections)

**TABLE 402.11
COMMERCIAL PRE-RINSE SPRAY VALVE MAXIMUM FLOW RATE**

PRODUCT CLASS BY SPRAY FORCE	MAXIMUM FLOW RATE (GPM)
Product Class 1 (<= 5.0 ounces-force)	1.00
Product Class 2 (> 5.0 ounces-force and <= 8.0 ounces-force)	1.20
Product Class 3 (> 8.0 ounces-force)	1.28

For SI units: 1 gallon per minute = 3.785 L/min, 1 ounce-force = 0.0625 pound-force.

**TABLE 1201.1
REFERENCED STANDARDS**

STANDARD NUMBER-YEAR	STANDARD TITLE	REFERENCED SECTION
IAPMO IGC 244-2021	Tub and Shower Flow-Reduction Systems	402.10

(portion of table not shown remains unchanged)

Note: IAPMO IGC 244 meets the requirements for a mandatory referenced standard in accordance with Section 15.0 of IAPMO's Regulations Governing Consensus Development of the Water Efficiency and Sanitation Standard.

SUBSTANTIATION:

Section 402.9 is being moved to a more appropriate location, and Section 402.10 is being proposed to address flow reduction devices with reference to IAPMO IGC 244. Tub and shower flow-reduction devices are intended for reducing the waste of water and energy by the use of a valve or system of valves that reduces the flow of water to a trickle once a set temperature is reached. This standard covers temperature-actuated flow-reduction devices and systems intended to be installed in tub spouts or immediately upstream of shower heads and specifies requirements for materials, physical characteristics, performance testing, and markings.

Furthermore, Table 402.11 is being added as the Department of Energy currently requires all pre-rinse spray valves to have a maximum flow rate of 1.28 gallons per minute (or less, depending on the product's spray force). Lastly, similar language was accepted by the UPC Technical Committee for Item #295 and Item #296.

See the energy conservation standards specified in the Code of Federal Regulations at 10 CFR 431.266:
<https://www.law.cornell.edu/cfr/text/10/431.266>

COMMITTEE ACTION: ACCEPT AS SUBMITTED

TOTAL ELIGIBLE TO VOTE: 30

VOTING RESULTS: AFFIRMATIVE: 28 NOT RETURNED: 2 CRAWFORD, WILLIAMS



CODES ADMINISTRATION

Proposals

Item #: 049

WEStand 2023 Section: 404.2.5

SUBMITTER: Edward R. Osann
Natural Resources Defense Council

RECOMMENDATION:
Revise text

404.0 Non-Sewered Sanitation Systems.

404.2 Installation. (remaining text unchanged)

404.2.5 Systems Employing Combustion. A non-sewered sanitation system employing combustion shall comply with the mechanical code.

~~**Exception:** A non-sewered sanitation system listed for unvented use.~~

SUBSTANTIATION:

The exception is unnecessary. The language of Section 404.0 has been approved by the UPC Technical Committee for inclusion as a voluntary appendix in the 2024 edition of the UPC, but this exception was stricken. This proposal will conform the language of WE•Stand with the forthcoming language of the UPC.

COMMITTEE ACTION: ACCEPT AS SUBMITTED

TOTAL ELIGIBLE TO VOTE: 30

VOTING RESULTS: AFFIRMATIVE: 28 NOT RETURNED: 2 CRAWFORD, WILLIAMS



CODES ADMINISTRATION

Proposals

Item #: 050

WEStand 2023 Section: 404.5

SUBMITTER: Billy Smith
Chair, WE-Stand Technical Committee

RECOMMENDATION:
Add new text

404.0 Non-Sewered Sanitation Systems.

404.5 Connection to Plumbing System Not Required. Unless the Authority Having Jurisdiction determines otherwise, a non-sewered sanitation system shall not be required to be connected to the drainage system of the building or premises.

SUBSTANTIATION:
Non-sewered sanitation systems collect, convey, and fully treat the specific input, to allow for safe reuse or disposal of the generated output. In many cases, these systems do not require connection to the networked sewer system. For these reasons, the above language is needed. This language is also consistent with the plumbing code.

COMMITTEE ACTION: ACCEPT AS SUBMITTED

TOTAL ELIGIBLE TO VOTE: 30

VOTING RESULTS: AFFIRMATIVE: 28 NOT RETURNED: 2 CRAWFORD, WILLIAMS



CODES ADMINISTRATION

Proposals

Item #: 051

WEStand 2023 Section: 406.3, Table 1201.1

SUBMITTER: Billy Smith
Chair, WE-Stand Technical Committee

RECOMMENDATION:
Revise text

406.0 Water Softeners and Treatment Devices.

406.3 Point-of-Use Reverse Osmosis Water Treatment Systems. Reverse osmosis water treatment systems installed in residential occupancies shall be equipped with automatic shutoff valves to prevent discharge when there is no call for producing treated water. Reverse osmosis water treatment systems shall comply be listed in accordance with NSF/ANSI 58 and ASSE 1086.

**TABLE 1201.1
REFERENCED STANDARDS**

STANDARD NUMBER-YEAR	STANDARD TITLE	REFERENCED SECTION
<u>ASSE 1086-2020*</u>	<u>Performance Specification for Reverse Osmosis Water Efficiency – Drinking Water</u>	<u>406.3</u>

(portion of table not shown remains unchanged)

Note: ASSE 1086 and NSF/ANSI 58 meet the requirements for mandatory referenced standards in accordance with Section 15.0 of IAPMO’s Regulations Governing Consensus Development of the Water Efficiency and Sanitation Standard.

SUBSTANTIATION:

Section 406.3 is being revised to include reference to ASSE 1086 as this standard covers water efficiency, automatic shut-off valves, and flow restrictor requirements for residential RO systems. Also covered is performance testing to address the membrane life concerns of high efficiency RO membranes. Additionally, this standard includes testing requirements for complete systems or components (RO membrane, automatic shut off valve, flow restrictor, etc.).

It should be noted that NSF/ANSI 58 does not overlap or conflict with ASSE 1086 as it focuses on the testing protocols associated with the reduction of chemicals through RO technology. ASSE 1086 however, focuses on the treatment technology and ensuring that efficiency does not compromise membrane life.

The revised language also clarifies that automatic shutoff valves are required for RO systems installed in residential occupancies. Lastly, similar language was accepted by the UPC Technical Committee for Item #300.

COMMITTEE ACTION: REJECT

COMMITTEE STATEMENT:

The proposed revisions to Section 406.3 limit the application of provisions to reverse osmosis (RO) water treatment systems used in residential occupancies. The existing language is sufficient as it applies to both residential and commercial applications. As stated in the provided substantiation, ASSE 1086 is specific to residential RO systems, and the language should make this distinction without revising the intent and applicability of the entire section.

TOTAL ELIGIBLE TO VOTE: 30

VOTING RESULTS: AFFIRMATIVE: 28 NOT RETURNED: 2 CRAWFORD, WILLIAMS

EXPLANATION OF AFFIRMATIVE:

BARNES: It is redundant to require that a system be listed to both standards, NSF/ANSI 58 and ASSE 1086. In order for a product to be listed to ASSE 1086 it must meet all of the requirements of NSF/ANSI 58. Listing to both standards would be redundant and would only serve to drive revenue to the certification bodies, of which we are one. Secondly, ASSE 1086 is not yet supported by the industry. Currently none of the accredited certification bodies in North America have any products listed to this standard.

KENDZEL: I support the comments submitted by Samantha Barnes. Duplication or redundant requirements covered in separate standards only leads to confusion in the marketplace and also increased costs to manufacturers for unneeded duplicate certifications.

KLEIN: Reflecting on Kent Sovocool and Samantha Barnes' comments, the proposal has two issues, one about redundancy, the other about automatic shut off in non-residential occupancies. Both need to be fixed in public comment.

SOVOCOOL: In my recollection, the negative commenters' statements are not the reason the group appropriately killed this. It was the attempt to effectively remove the auto shutoff requirement for non-residential. That would have been detrimental to the water conservation value of the standard.



CODES ADMINISTRATION

Proposals

Item #: 052

WEStand 2023 Section: 407.3, Table 1201.1

SUBMITTER: Robert Pickering
Eastern Research Group, Inc.
EPA WaterSense

RECOMMENDATION:
Revise text

407.0 Commercial Food Service.

407.3 Combination Ovens. Combination ovens shall ~~be in accordance with the Energy Star program requirements. not use water in the convection mode except when utilizing a moisture nozzle for food products in the oven. The total amount of water used by the moisture nozzle in the convection mode shall not exceed a half a gallon per hour per oven cavity. When operating in the steamer mode, combination ovens shall not use more than 1.5 gallons (5.7 L) per hour per pan.~~

**TABLE 1201.1
REFERENCED STANDARDS**

STANDARD NUMBER-YEAR	STANDARD TITLE	REFERENCED SECTION
Energy Star-2022	Program Requirements for Commercial Ovens	407.3

(portion of table not shown remains unchanged)

Note: The Energy Star Program Requirements for Commercial Ovens meets the requirements for a mandatory referenced standard in accordance with Section 15.0 of IAPMO’s Regulations Governing Consensus Development of the Water Efficiency and Sanitation Standard.

SUBSTANTIATION:

EPA’s Energy Star program, in coordination with WaterSense, is incorporating water efficiency criteria into Version 3.0 of its specification for commercial ovens, which includes combination ovens. With the specification publishing April 12, 2022 and compliant products being available in the marketplace by the time of publication of 2023 WE•Stand, EPA suggests aligning water efficiency criteria with the new Energy Star specification.

ENERGY STAR® Program Requirements for Commercial Ovens:

<https://www.energystar.gov/sites/default/files/ENERGY%20STAR%20Version%203.0%20Commercial%20Ovens%20Final%20Specification.pdf>

COMMITTEE ACTION: REJECT

COMMITTEE STATEMENT:

The proposal lacks technical substantiation to justify the proposed change. Furthermore, this proposal removes specific water efficiency criteria required for combination ovens.

TOTAL ELIGIBLE TO VOTE: 30

VOTING RESULTS: AFFIRMATIVE: 28 NOT RETURNED: 2 CRAWFORD, WILLIAMS

EXPLANATION OF AFFIRMATIVE:

OSANN: The latest Energy Star Specification for Commercial Ovens (Version 3.0) covers more types of ovens and appears to be as rigorous, if not more so, than the current WE•Stand language. Section 407.3 should be reworked in public comment to encompass all water-using commercial ovens that are within the scope of the Energy Star specification.



CODES ADMINISTRATION

Proposals

Item #: 053

WEStand 2023 Section: 408.3

SUBMITTER: Billy Smith
Chair, WE-Stand Technical Committee

RECOMMENDATION:
Add new text

408.0 Medical and Laboratory Facilities.

408.3 Steam Sterilizers. Controls shall be installed to limit the discharge temperature of condensate or water from steam sterilizers to 140°F (60°C) or less. A venturi-type vacuum system shall not be utilized with vacuum sterilizers.

SUBSTANTIATION:

Steam sterilizers are an essential part of the decontamination and sterilization process performed by sterile processing departments in healthcare facilities. Of all the methods available for sterilization, heat in the form of saturated steam under pressure is the most widely used and the most dependable. For this reason, the proposed addition is best suited under Section 408.0. The proposed language is also consistent with the plumbing code.

COMMITTEE ACTION: REJECT

COMMITTEE STATEMENT:

The proposed new requirements for steam sterilizers do not address water efficiency and conservation. The presented requirements pertain to discharge temperature limits and do not offer a benefit that aligns with the purpose of this standard. Such language is better suited within the plumbing code.

TOTAL ELIGIBLE TO VOTE: 30

VOTING RESULTS: AFFIRMATIVE: 22 NEGATIVE: 6 NOT RETURNED: 2 CRAWFORD, WILLIAMS

EXPLANATION OF AFFIRMATIVE:

KENDZEL: I agree with the committee decision to reject; however, it would appear that through public comment, revisions can be made to the proposal to address some of the concerns and better clarify the intent.

KLEIN: The proposal needs to be amended to be more clear about the water efficiency benefits of the two provisions. It appears that both are related running water down the drain to cool heated discharge water. Section 407.6 talks about not using potable water to cool discharges in food service. Is something like that also relevant for Section 407.7?

EXPLANATION OF NEGATIVE:

ALLEN: I agree with Kent Sovocool's comment.

KOELLER: The so-called "substantiation" offered by the committee for rejection is FALSE. By controlling the temperature of water waste and prohibiting a venturi-type vacuum system DOES provide a water efficiency benefit. It appears that the committee again acted in haste to reject a legitimate proposal.

LENGER: The proposal has merit.

PAPE: The proposal only needs to add language that the purpose is to avoid tempering water at discharge.

PREMER: I agree with Kent Sovocool as well. Venturis by definition work in this manner.

SOVOCOOL: Agree with John Koeller. To add further detail on his second point, the venturi requires a constantly running source due to the physics of how a venturi vacuum works. This should not have been rejected.



CODES ADMINISTRATION

Proposals

Item #: 054

WEStand 2023 Section: 409.1

SUBMITTER: Jim Kendzel
Chair, WE-Stand Premise Water Supply System Design Task Group

RECOMMENDATION:
Revise text

409.0 Leak Detection and Control.

409.1 General. Where installed, leak detection and control devices shall comply with IAPMO IGC 115 or IAPMO IGC 349. Leak detection with control devices shall not be installed where they isolate fire **sprinklerprotection** systems.

SUBSTANTIATION:

Section 409.1 is being revised to expand the current provisions for leak detection and control devices. Since there are other hose cabinets which may be supplied beyond fire sprinklers, the above modification is necessary.

COMMITTEE ACTION: ACCEPT AS SUBMITTED

TOTAL ELIGIBLE TO VOTE: 30

VOTING RESULTS: AFFIRMATIVE: 25 NEGATIVE: 2 ABSTAIN: 1 NOT RETURNED: 2 CRAWFORD, WILLIAMS

EXPLANATION OF AFFIRMATIVE:

BARNES: I agree with the comments that "fire suppression" is a more common term and that this proposal could be revised through public comment.

SOVOCOOL: While I agree with the negative voters' points, this is still better than the "sprinkler" that is currently in there.

EXPLANATION OF NEGATIVE:

LENGER: Fire suppression is more common.

PAPE: The term fire "suppression" (instead of "protection") is used more commonly. I am also unsure "isolate" is the correct term to use. It might be better clarified to say the device cannot restrict the flow of water to fire suppression systems.

EXPLANATION OF ABSTAIN:

LANDO: "Fire suppression" is the more common term and should be revised in the public comment period.



CODES ADMINISTRATION

Proposals

Item #: 055

WEStand 2023 Section: 409.1

SUBMITTER: Billy Smith
Chair, WE-Stand Technical Committee

RECOMMENDATION:
Revise text

409.0 Leak Detection and Control.

409.1 General. Where installed, leak detection and control devices shall comply with ~~IAPMO IGC 115 or IAPMO IGC 349~~ ANSI/CAN/IAPMO Z1349. Leak detection ~~with and~~ control devices shall not be installed where they isolate fire sprinkler systems.

Note: ANSI/CAN/IAPMO Z1349 meets the requirements for a mandatory referenced standard in accordance with Section 15.0 of IAPMO's Regulations Governing Consensus Development of the Water Efficiency and Sanitation Standard.

SUBSTANTIATION:

As stated in the preface of the standard, IAPMO Z1349 supersedes IAPMO IGC 115 (Automatic Water Leak Detection Devices) and IAPMO IGC 349 (Electronic Plumbing Supply System Integrity Protection Devices).

IAPMO Z1349 is an American National Standard covering devices for detection, monitoring, and control of water supply and distribution systems in commercial and residential applications. This standard also specifies requirements for materials, performance testing, environmental limitations, installation, and markings. Furthermore, this change is consistent with the plumbing code.

COMMITTEE ACTION: ACCEPT AS AMENDED BY THE TC

409.0 Leak Detection and Control.

409.1 General. Where installed, leak detection and control devices shall comply with IAPMO IGC 115, IAPMO IGC 349, or ANSI/CAN/IAPMO Z1349. Leak detection and control devices shall not be installed where they isolate fire ~~sprinkler protection~~ systems.

COMMITTEE STATEMENT:

The proposal is being revised to keep reference to IAPMO IGC 349 and IAPMO IGC 115. There is a concern with the availability of leak detection and control devices currently listed to ANSI/CAN/IAPMO Z1349, and therefore the Technical Committee prefers the inclusion of all three standards within Section 409.1.

Additionally, the term "sprinkler" is being modified to "protection" based on the action taken for Item #054.

TOTAL ELIGIBLE TO VOTE: 30

VOTING RESULTS: AFFIRMATIVE: 17 NEGATIVE: 11 NOT RETURNED: 2 CRAWFORD, WILLIAMS

Note: Item # 055 failed to achieve the necessary two-thirds affirmative vote of returned ballots. In accordance with Section 6.8.2 of the Regulations Governing Consensus Development of the Water Efficiency and Sanitation Standard, a public comment is requested for this proposal. The Technical Committee will reconsider this proposal as a public comment.

EXPLANATION OF AFFIRMATIVE:

THOMPSON: It can take several years for manufacturers and third party certifiers to shift the listing of products to a newer standard like IAPMO Z1349. The committee's amendment to include all the applicable standards in this proposal provides the most viable option for this situation type. Where the code is developed on a 3-year cycle and the new standard has recently been published. Since it will provide the best direction to users of the code. The term "isolate" is in the current text of the WE•Stand and there is no suggestion to change or alter this part of the text in this proposal. I don't see the benefits of rejecting the proposal based on this concern as it is not part of the proposed change.

EXPLANATION OF NEGATIVE:

BARNES: I agree with the comments made by the Southern Nevada Water Authority (Kent Sovocool) and the American Supply Association (Jim Kendzel).

KENDZEL: I am concerned about the comments made by Kent Sovocool related to lack of industry participation in the development of the standard. Until there can be verification that there was significant participation from the manufacturers currently in the marketplace, I will not be able to support this proposal.

KLEIN: I agree with Thomas Pape.

KOELLER: I am concerned over the observation made by Mr. Kent Sovocool and am changing my vote.

LANDO: I agree with Thomas Pape's comments.

LANSING: I agree with Thomas Pape's comments.

LENGER: Agree with Thomas Pape.

MCLEOD: I agree with the American Supply Association (Jim Kendzel) and the Southern Nevada Water Authority (Kent Sovocool).

PAPE: The term "isolate" is not clear. It would be clearer to say the device shall not be installed where it could restrict the flow. Also, I usually hear this referred to as fire SUPPRESSION system, rather than fire protection systems.

PREMER: I am in agreement with Thomas Pape.

SOVOCOOL: Almost no product is labeled yet for that very new IAPMO Z1349 standard. My opinion is that one manufacturer dominated the development of that standard and happens to have the only product that aligns with it. This is just too early in the development of leak detection devices to be used in this way.



CODES ADMINISTRATION

Proposals

Item #: 056

WEStand 2023 Section: 411.1 - 411.1.2, Table 411.1

SUBMITTER: Thomas Pape
Chair, WE-Stand Water Metering Applications Task Group

RECOMMENDATION:
Revise text

411.0 Meters.

411.1 Required. A water meter shall be required for each building site connected to a public water system, including municipally supplied reclaimed (recycled) water. ~~In other than single-family houses, a~~ dedicated meter shall be installed in accordance ~~to~~with Table 411.1.

411.1.1 Meter Performance Specifications. Consumption data shall be reported within 0.35 ft³ (0.01 m³) resolution at each 15-minute interval. Flow rate data shall be reported at each 0.25 gallon per minute (gpm) (1.0 L/min) change in flow rate.

411.1.2 Unusual Flow. Data shall be analyzed when one or more of the following unusual flow conditions are met:
 (1) Consumption measured is greater than 0.25 gallon per minute (gpm) (1.0 L/min) for more than 6 consecutive hours at a consistent (+/- 0.5 gpm) (+/- 2 L/min) measurement at each interval.
 (2) Flow rate exceeds 0.25 gallon per minute (gpm) (1.0 L/min) more than 4 times within a 15-minute interval, where each peak is within 0.5 gpm (2.0 L/min) of each other during low water demand period(s).
 (3) Average water consumption for a 15-minute interval exceeds the average water consumption by greater than 50 percent when compared to the average usage calculated in the previous measured intervals.

**TABLE 411.1
DEDICATED WATER METERING REQUIREMENTS**

APPLICATION	REQUIREMENTS
Landscape Irrigation	Landscape irrigation water where either of the following conditions exist: 1. Single-family residential projects: Total accumulated landscape area with <u>served by</u> in-ground irrigation system exceeds 2500 sq. ft. square feet (ft²) (232 m ²), or 2. Other than single-family residential projects: Total accumulated landscape area served by in-ground irrigation system using an automatic irrigation controller exceeds 1500 sq. ft. 1000 square feet (ft²) (13993 m²) Exception: Where the water purveyor provides a separate water supply meter that serves only the irrigation system, an additional dedicated meter is not required.

(portion of table not shown remains unchanged)

SUBSTANTIATION:

Section 411.1 is being revised to appropriately reflect the applicability of Table 411.1. In particular, the metering requirements for landscape irrigation are split into either single-family residential projects and other than single-family. The table has also been updated for clarity and further supports the changes made to Section 411.1.

Section 411.1.1 (Meter Performance Specifications) is needed in order to properly collect consumption and flow rate data at a resolution level which allows for the detection of abnormalities or unusual flow conditions. This language provides the necessary baseline for meter data resolution and reporting performance.

Section 411.1.2 (Unusual Flow) has been added as a baseline for data analysis results to indicate an unusual flow condition. It is necessary to analyze consumption and flow rate data in a continuous and comparative process to detect changes that indicate fixture failure. For these reasons, the additional proposed language is needed.

COMMITTEE ACTION: ACCEPT AS AMENDED BY THE TC

411.0 Meters.

411.1 Required. A water meter shall be required for each building site connected to a public water system, including municipally supplied reclaimed (recycled) water. A dedicated meter shall be installed in accordance with Table 411.1.

411.1.1 Meter Performance Specifications. Consumption data shall be capable of being reported within 0.35 ft³ (0.01 m³) resolution at each 15-minute interval. Flow rate data shall be capable of being reported at each 0.25 gallon per minute (gpm) (1.0 L/min) change in flow rate.

411.1.2 Unusual Flow. Data shall be capable of being analyzed when one or more of the following unusual flow conditions are met:

- (1) Consumption measured is greater than 0.25 gallon per minute (gpm) (1.0 L/min) for more than 6 consecutive hours at a consistent (+/- 0.5 gpm) (+/- 2 L/min) measurement at each interval.
- (2) Flow rate exceeds 0.25 gallon per minute (gpm) (1.0 L/min) more than 4 times within a 15-minute interval, where each peak is within 0.5 gpm (2.0 L/min) of each other during low water demand period(s).
- (3) Average water consumption for a 15-minute interval exceeds the average water consumption by greater than 50 percent when compared to the average usage calculated in the previous measured intervals.

**TABLE 411.1
DEDICATED WATER METERING REQUIREMENTS**

APPLICATION	REQUIREMENTS
Landscape Irrigation	Landscape irrigation water where either of the following conditions exist: 1. Single-family residential projects: Total accumulated landscape area served by in-ground irrigation system exceeds 2500 square feet (ft ²) (232 m ²), or 2. Other than single-family residential projects: Total accumulated landscape area served by in-ground irrigation system exceeds 1000 square feet (ft ²) (93 m ²) Exception: Where the water purveyor provides a separate water supply meter that serves only the irrigation system, an additional dedicated meter is not required.

(portion of table not shown remains unchanged)

COMMITTEE STATEMENT:

The modification specifies that "data shall be capable of being" reported or analyzed. Such phrasing assists with enforceability and removes ambiguous language.

TOTAL ELIGIBLE TO VOTE: 30

VOTING RESULTS: AFFIRMATIVE: 27 NEGATIVE: 1 NOT RETURNED: 2 CRAWFORD, WILLIAMS

EXPLANATION OF NEGATIVE:

KENDZEL: I voted negative based on my meeting notes indicating that more work on the text was needed by the Task Group. Unfortunately, my notes are not complete as to what additional clarity is needed so I am hoping other Committee members may remember issue discussed at the meeting. The modification did not fully address the concerns discussed.



CODES ADMINISTRATION

Proposals

Item #: 057

WEStand 2023 Section: 412.4 - 412.5.2

SUBMITTER: Jazmin Curiel
Self

RECOMMENDATION:
Revise text

412.0 HVAC Water Efficiency.

412.4 Evaporative Cooler Water Use. Evaporative cooling systems (~~also known as swamp coolers~~) shall use less than 3.5 gallons (13.2 L) of water per ton-hour of cooling when system controls are set to maximum water use. Water use, expressed in maximum water use per ton-hour of cooling, shall be marked on the device and included in product user manuals, product information literature, and manufacturer's installation instructions. Water use information shall be readily available at the time of code compliance inspection.

412.4.1 Overflow Alarm. Cooling systems shall be equipped with an overflow alarm to alert building owners, tenants, or maintenance personnel when the water refill valve continues to allow water to flow into the reservoir when the reservoir is ~~already~~ full. The alarm shall have a minimum sound pressure level rating of 85 dBA measured at a distance of ~~ten~~10 feet (~~3048 mm~~).

412.4.2 Automatic Pump Shut-Off. Cooling systems shall automatically cease pumping water to the evaporation pads when airflow across evaporation pads ceases.

412.4.3 Cooler Reservoir Discharge. A water quality management system (either timer or water quality sensor) ~~is required shall be provided~~. Where timers are used, the time interval between discharge of reservoir water shall be set to 6 hours or greater of cooler operation. Where water quality sensors are used, the discharge of reservoir water shall be set for greater 800 ppm or greater of Total Dissolved Solids (TDS). Continuous discharge or continuous bleed systems ~~are prohibited shall be prohibited~~.

412.4.4 Discharge Water Reuse. Discharge water shall be reused where appropriate applications exist on site. Where a nonpotable water source system exists on site, evaporative cooler discharge water shall be collected and discharged to ~~such the~~ collection system.

Exception: Where the reservoir water adversely affects the quality of the nonpotable water supply making the nonpotable water unusable for its intended purposes.

412.4.5 Discharge Water to Drain. Where discharge water is not recovered for reuse, the sump overflow line shall not be directly connected to a drain. Where the discharge water is ~~put discharged~~ into a sanitary drain, a minimum 6 inch (152 mm) air gap is required between the termination of the discharge line and the drain opening. The discharge line shall terminate in a location that is readily visible to the building owner, tenants, or maintenance personnel.

412.5 Use of Reclaimed (Recycled) and On-Site Treated Nonpotable Water for Cooling. (remaining text unchanged)

412.5.1 Drift Eliminator. A drift eliminator shall be utilized in a cooling system, utilizing alternate sources of water, where the aerosolized water ~~may come is capable of coming~~ in contact with employees or members of the public.

412.5.2 Disinfection. A biocide shall be used to treat the cooling system recirculation water where the recycled water ~~may come is capable of coming~~ in contact with employees or members of the public.

SUBSTANTIATION:

The above sections are being revised to correlate with the mechanical code. Additionally, the proposed revisions are necessary to prevent the use of nonmandatory language in the body of the WE-Stand.

COMMITTEE ACTION: REJECT

COMMITTEE STATEMENT:

The proposed revisions use poor code language and do not improve existing requirements. In particular, the phrase "capable of coming in contact with employees" is unenforceable. Furthermore, the additional reference to the "manufacturer's installation instructions" is repetitive and unnecessary as compliance is already addressed within the general requirements of the standard.

TOTAL ELIGIBLE TO VOTE: 30

VOTING RESULTS: AFFIRMATIVE: 28 NOT RETURNED: 2 CRAWFORD, WILLIAMS



CODES ADMINISTRATION

Proposals

Item #: 058

WEStand 2023 Section: 414.1, Table 1201.1

SUBMITTER: Billy Smith
Chair, WE-Stand Technical Committee

RECOMMENDATION:
Revise text

414.0 Water-Powered Sump Pumps.

414.1 General. Sump pumps powered by potable or reclaimed (recycled) water pressure shall ~~only~~ be used as an emergency backup pump and shall comply with IAPMO PS 119. The water-powered pump shall be equipped with a battery powered alarm having a minimum rating of 85 dBa at 10 feet (3048 mm). Water-powered pumps shall have a water efficiency factor of pumping at least 1.4 gallons (5.3 L) of water to a height of 10 feet (3048 mm) for every gallon of water used to operate the pump, measured at a water pressure of 60 psi (414 kPa). Pumps shall be clearly labeled as to the gallons of water pumped per gallon of potable water consumed.

Water-powered stormwater sump pumps shall be equipped with a reduced pressure principle backflow prevention assembly.

**TABLE 1201.1
REFERENCED STANDARDS**

STANDARD NUMBER-YEAR	STANDARD TITLE	REFERENCED SECTION
<u>IAPMO PS 119-2012a^{e3}</u>	<u>Water-Powered Sump Pumps</u>	<u>414.1</u>

(portion of table not shown remains unchanged)

Note: IAPMO PS 119 meets the requirements for a mandatory referenced standard in accordance with Section 15.0 of IAPMO’s Regulations Governing Consensus Development of the Water Efficiency and Sanitation Standard.

SUBSTANTIATION:

Water powered emergency backup sump pumps are commonly used in the industry. IAPMO PS 119 covers water powered sump pumps intended to provide emergency or backup groundwater or storm water removal from buildings in the event of power failure. The standard also specifies requirements for materials, physical characteristics, performance testing, and markings.

Once water rises past the normal high-water level in the pit, the water powered pump’s float lifts, causing it to take over the pumping duties and prevent water from overflowing out of the sump pit. The addition of the standard is required to ensure that these emergency pumps meet the minimum safety and performance requirements. This language is also consistent with the plumbing code.

COMMITTEE ACTION: ACCEPT AS SUBMITTED

TOTAL ELIGIBLE TO VOTE: 30

VOTING RESULTS: AFFIRMATIVE: 28 NOT RETURNED: 2 CRAWFORD, WILLIAMS



CODES ADMINISTRATION

Proposals

Item #: 059

WEStand 2023 Section: 214.0, 415.0 - 415.3, 415.20

SUBMITTER: Thomas Pape
Chair, WE-Stand Water Efficient Landscaping Task Group

RECOMMENDATION:
Revise text

415.0 Sustainable Landscape Design and Installation Irrigation Systems.

415.1 General. ~~Where landscape irrigation systems are installed, they~~ Vegetated landscapes greater than 500 square feet (ft²) (46.5 m²) shall comply with Sections 415.2 through ~~415.16~~ Section 415.19. Vegetated roofs shall be in accordance with Section 415.20.

~~**415.1.1 Irrigation Design and Installation.** The Authority Having Jurisdiction shall have the authority to require landscape irrigation contractors, installers, or designers to demonstrate competency. The system shall be designed and record drawings showing changes during installation shall be made available for the owner and for any required inspections. Where required by the Authority Having Jurisdiction, the contractor, installer, or designer shall be licensed, certified, or both to perform such work.~~

415.2 Required Documentation. The following documents shall be provided to the owner and shall be readily accessible onsite to the Authority Having Jurisdiction at the time of inspection:

- (1) The landscape plan and irrigation design as approved.
- (2) Drawings and records showing any changes during installation.
- (3) The report of the irrigation audit required by Section 415.19.
- (4) Irrigation controller information required by Section 415.8.1.

415.3 Qualifications. Where permits are required, the Authority Having Jurisdiction shall have the authority to require contractors, installers, or service technicians to demonstrate competency. Where determined by the Authority Having Jurisdiction, the irrigation contractor, installer, or service technician shall be approved to perform such work.

(renumber remaining sections)

~~415.2-415.20~~ **Vegetative-Vegetated Roofs and Walls.** (remaining text unchanged)

214.0 - L -

Landscape. That portion of a lot not covered by the footprint of a building or any hardscape including driveways, sidewalks, decks, patios, swimming pools, or spas.

Landscape, Vegetated. That portion of a landscape in which living plant material and porous landscape elements are installed or maintained, or is prepared for the installation of such material, not including vegetated roofs or undisturbed native vegetation maintained without supplemental irrigation.

SUBSTANTIATION:

The title of Section 415.0 is being updated to better reflect the provisions covered. The section is also being updated to clarify that requirements are only applicable to vegetated landscapes greater than 500 square feet to prevent these provisions from being applied where they would offer insignificant benefits.

Since vegetated roofs and walls are not considered part of the landscape area, the section is being moved to a more appropriate location. Additionally, definitions for "landscape" and "vegetated landscape" have been proposed to support the updated requirements. The provided terminology is clear and necessary for inclusion.

COMMITTEE ACTION: ACCEPT AS AMENDED BY THE TC

415.0 Sustainable Landscape Design and Installation.

415.1 General. Vegetated landscapes greater than 500 square feet (ft²) (46.5 m²) shall comply with Section 415.2 through Section 415.19. Vegetated roofs shall be in accordance with Section 415.20.

415.2 Required Documentation. The following documents shall be provided to the owner and shall be readily accessible onsite to the Authority Having Jurisdiction at the time of inspection:

- (1) The landscape plan and irrigation design as approved.
- (2) Drawings and records showing any changes during installation.
- (3) The report of the irrigation audit required by Section 415.19.
- (4) Irrigation controller information required by Section 415.8.1.

415.3 Qualifications. Where permits are required, the Authority Having Jurisdiction shall have the authority to require contractors, installers, or service technicians to demonstrate competency. Where determined by the Authority Having Jurisdiction, the irrigation contractor, installer, or service technician shall be approved to perform such work.

(renumber remaining sections)

415.20 Vegetated Roofs and Walls. Irrigation systems using potable water for vegetative roofs and walls are prohibited.

214.0 - L -

Landscape. That portion of a lot not covered by the footprint of a building or any hardscape including driveways, sidewalks, decks, patios, swimming pools, or spas.

Landscape, Vegetated. That portion of a landscape in which living plant material and porous landscape elements are installed or maintained, or is prepared for the installation of such material, not including vegetated roofs or undisturbed native vegetation maintained without supplemental irrigation.

COMMITTEE STATEMENT:

The title of Section 415.0 is being updated to remove the term "Sustainable" as it is not necessary for the description of the section and may be considered vague and unenforceable.

As requested by the Technical Committee, Section 415.20 is shown for reference.

TOTAL ELIGIBLE TO VOTE: 30

VOTING RESULTS: AFFIRMATIVE: 27 ABSTAIN: 1 NOT RETURNED: 2 CRAWFORD, WILLIAMS

EXPLANATION OF ABSTAIN:

LANDO: The proposal is dividing traditional landscape areas into "Landscape" and "Landscape, Vegetated" which I understand for the purpose of the WE•Stand. However, it is unclear as to where a permeable hardscape surface would fall under. I suggest that this is clarified during the public comment period.

FYI - The typical approach to city planning and stormwater management requirements are to make areas outside of the building envelope into permeable and non-permeable areas. The permeable areas are then further divided by living and non-living elements. My hope would be that future WE•Stand editions of this section could better align with what planning departments are already doing.



CODES ADMINISTRATION

Proposals

Item #: 060

WEStand 2023 Section: 415.2, 415.4 - 415.4.3, Table 1201.1

SUBMITTER: Thomas Pape
Chair, WE-Stand Water Efficient Landscaping Task Group

RECOMMENDATION:
Revise text

~~**415.2415.4 Plant and Irrigation System Limitations.** Nuisance, invasive and noxious plants as defined by the Authority Having Jurisdiction shall not be used in the landscape.~~ Plants not requiring supplemental irrigation shall be used in comprise no less than 60 percent of the vegetated landscape that is not principally used as an athletic field or public recreation site. ~~In-ground~~ An irrigation system shall not be installed in-to serve more than 40 percent of the vegetated landscaped area.

Exceptions:

- a. Where average annual rainfall is less than 12 inches (305 mm) and in climate zones landscape areas where the plant materials have an annual ET_c of not exceeding 15 inches (381 mm), an in-ground irrigation system shall be allowed to be installed in 80 percent of the vegetated landscape;
- b. ~~Where neither potable or reclaimed (recycled) water is used in the irrigation system, an in-ground irrigation system shall be allowed in 100 percent of the landscaped area and vegetative roofs. Where only onsite alternate water sources in accordance with Chapters 6, 7, 8, or 9 are used for irrigation.~~
- e. ~~Drip irrigation and microspray systems are not considered inground systems.~~

~~**415.4.1 Noxious Plants.** Nuisance, invasive and noxious plants as defined by the Authority Having Jurisdiction shall not be installed in the landscape.~~

~~**415.4.2 Athletic Fields.** Athletic fields shall be irrigated with either reclaimed (recycled) or onsite alternate water sources provided in accordance with Chapters 6, 7, 8, or 9. Golf courses shall be planted in landscaping which does not require supplemental irrigation except for tees, fairways, and greens. The use of potable water on newly installed athletic fields shall be permitted for a period of not more than 18 months after installation or as approved by the Authority Having Jurisdiction.~~

~~**415.4.3 Plant Grouping.** Plants shall be grouped into hydrozones based on water use classifications. Irrigation systems shall be designed to provide water requirements to hydrozones as specified by the water use classification of the plant species. Minimum plant water demands shall be determined in accordance with ANSI/ASABE S623.1.~~

**TABLE 1201.1
REFERENCED STANDARDS**

STANDARD NUMBER-YEAR	STANDARD TITLE	REFERENCED SECTION
<u>ANSI/ASABE S623.1-2017*</u>	<u>Determining Landscape Plant Water Demands</u>	<u>415.4.3</u>

(portion of table not shown remains unchanged)

Note: ANSI/ASABE S623.1 meets the requirements for a consensus referenced standard in accordance with Section 15.2 of IAPMO's Regulations Governing Consensus Development of the Water Efficiency and Sanitation Standard.

SUBSTANTIATION:

Section 415.4 (Plant and Irrigation System Limitations) is being revised to include additional relevant subsections pertaining to noxious plants, athletic fields, and plant grouping. All of these topics should be addressed within the specified plant and irrigation system limitations.

Although noxious plant provisions are more aligned with environmental site benefits, such language is necessary for designing landscapes and complying with local jurisdictions as these plants may be invasive and toxic. In some cases, noxious plants may crowd out native vegetation. In any case, the requirements vary by geographical setting.

Section 415.4.2 (Athletic Fields) is being added to ensure that irrigation is focused on actual playing surfaces. The language pertaining to newly installed athletic fields and the landscape establishment phase is needed as potable water may be required to flush out salts within the soil.

Section (415.4.3 Plant Grouping) is needed for grouping of plants into hydrozones based on water classifications. Such plant grouping conserves water used for irrigation and promotes healthier vegetation. In support of this, ANSI/ASABE S623.1 is referenced as it provides the methodology for determining the minimum plant water demands used for such grouping.

COMMITTEE ACTION: ACCEPT AS SUBMITTED

TOTAL ELIGIBLE TO VOTE: 30

VOTING RESULTS: AFFIRMATIVE: 28 NOT RETURNED: 2 CRAWFORD, WILLIAMS



CODES ADMINISTRATION

Proposals

Item #: 061

WEStand 2023 Section: 415.3 - 415.5.2.1

SUBMITTER: Thomas Pape
Chair, WE-Stand Water Efficient Landscaping Task Group

RECOMMENDATION:
Revise text

~~415.3~~**415.5 Maximum Velocity.** (remaining text unchanged)

~~415.4~~**415.6 Backflow Protection.** Potable water ~~and reclaimed water~~ supplies to ~~landscape~~ irrigation systems shall be protected from backflow in accordance with the plumbing code and Authority Having Jurisdiction.

~~415.5~~**415.7 Use of Alternate Water Sources for Landscape Irrigation.** Where available by pre-existing treatment, storage or distribution network, and where approved by the Authority Having Jurisdiction, ~~alternative alternate~~ water source(s) complying with Chapter 6 shall be utilized for ~~landscape~~ irrigation. Where adequate capacity and volumes of pre-existing alternative water sources are available, the irrigation system shall be designed to use a minimum of 75 percent of ~~alternative alternate~~ water ~~for to meet~~ the annual irrigation demand ~~before supplemental potable water is used~~.

Exception: Plants grown for food production for direct human consumption.

~~415.5.4~~**415.7.1 Master Valve.** Where continuously pressurized alternate water sources supply an ~~existing~~ irrigation system, a master valve shall be installed at the point where the alternate water sources supply piping connects to the ~~existing~~ irrigation system downstream of the backflow preventer where required.

~~415.5.2~~**415.7.2 Identification.** Where alternate water sources supply an ~~existing~~ irrigation system, the ~~existing~~ sprinkler heads, valve boxes, the continuously pressurized line supplying the irrigation master valve, or any other components required by the Authority Having Jurisdiction, shall be colored purple. The piping supplying the irrigation master valve shall be identified in accordance with Chapter 6.

~~415.5.2.1~~**415.7.3 Additional Zones.** (remaining text unchanged)

(renumber remaining sections)

SUBSTANTIATION:

The proposed changes to Section 415.6 and Section 415.7 provide clarity and remove unnecessary language. The reclaimed water supply to an irrigation system does not require backflow prevention, and the type of irrigation is already specified under Section 415.1 (Sustainable Landscape Design and Installation – General).

Additionally, Section 415.7.1 and Section 415.7.2 are being revised to remove the word “existing” as the provisions apply to both new and existing irrigation systems subject to this standard.

COMMITTEE ACTION: ACCEPT AS SUBMITTED

TOTAL ELIGIBLE TO VOTE: 30

VOTING RESULTS: AFFIRMATIVE: 28 NOT RETURNED: 2 CRAWFORD, WILLIAMS



CODES ADMINISTRATION

Proposals

Item #: 062

WEStand 2023 Section: 415.4, Table 1201.1

SUBMITTER: Jazmin Curiel
Self

RECOMMENDATION:
Revise text

415.0 Landscape Irrigation Systems.

415.4 Backflow Protection. Potable water and reclaimed water supplies to lawn sprinklers and landscape irrigation systems, having no pumps or connections for pumping equipment and no chemical injection or provisions for chemical injection, shall be protected from backflow ~~in accordance with the plumbing code and Authority Having Jurisdiction. by one of the following devices:~~

- (1) Atmospheric vacuum breaker (AVB).
- (2) Pressure vacuum breaker backflow prevention assembly (PVB).
- (3) Spill-resistant pressure vacuum breaker (SVB).
- (4) Reduced-pressure principle backflow prevention assembly (RP).
- (5) A valve complying with IAPMO PS 72

**TABLE 1201.1
REFERENCED STANDARDS**

STANDARD NUMBER-YEAR	STANDARD TITLE	REFERENCED SECTION
<u>IAPMO PS 72-2019</u>	<u>Valves with Atmospheric Vacuum Breakers</u>	<u>415.4(5)</u>

(portion of table not shown remains unchanged)

Note: IAPMO PS 72 meets the requirements for a mandatory referenced standard in accordance with Section 15.0 of IAPMO's Regulations Governing Consensus Development of the Water Efficiency and Sanitation Standard.

SUBSTANTIATION:

Section 415.4 is being updated to include a list of appropriate backflow prevention devices for protection of potable water and reclaimed water supplies to lawn sprinklers and landscape irrigation systems. The proposed list is consistent with the most recent revisions made to the plumbing code.

The inclusion of IAPMO PS 72 is appropriate as it covers valves for cold water installations requiring an integral anti-siphon device to prevent house water contamination when installed per the manufacturer's instructions. Table 1201.1 has been revised to include this newly referenced standard.

COMMITTEE ACTION: REJECT

COMMITTEE STATEMENT:

The WE•Stand refers the user to the plumbing code for backflow prevention requirements. The plumbing code contains various backflow prevention methods along with applicable industry standards for compliance. Rather than simply providing a list of approved devices, the provisions of the plumbing code should be applied.

TOTAL ELIGIBLE TO VOTE: 30

VOTING RESULTS: AFFIRMATIVE: 28 NOT RETURNED: 2 CRAWFORD, WILLIAMS



CODES ADMINISTRATION

Proposals

Item #: 063

WEStand 2023 Section: 415.6, Table 1201.1

SUBMITTER: Robert Pickering
Eastern Research Group, Inc.
EPA WaterSense

RECOMMENDATION:
Revise text

415.0 Landscape Irrigation Systems.

415.6 Irrigation Control Systems. Where installed as part of a landscape irrigation system, irrigation control systems shall:

- (1) ~~Automatically adjust the irrigation schedule to respond to plant water needs determined by weather or soil moisture conditions. Utilize an irrigation controller listed to either the EPA WaterSense Specification for Weather-Based Irrigation Controllers or the EPA WaterSense Specification for Soil Moisture-Based Irrigation Controllers to schedule irrigation and/or suspend irrigation when adequate soil moisture is present.~~
- (2) Utilize one or more on-site sensors or remote weather data to inhibit or suspend irrigation ~~when adequate soil moisture is present or~~ during rainfall or freezing conditions.
- (3) ~~Utilize either one or more on-site sensors or a weather-based irrigation controller listed to the US EPA WaterSense Weather Based Irrigation Controllers Specification to suspend irrigation when adequate soil moisture is present for plant growth.~~
- (4) ~~Have the capability to program multiple and different run times for each irrigation zone to enable cycling of water applications and durations to mitigate water flowing off of the intended irrigation zone.~~
- (5) ~~Be capable of indicating to the user when it is not receiving a signal or local sensor input.~~
- (6) ~~Be capable of allowing for a manual operation troubleshooting test cycle and shall automatically return to sensor input mode within some period of time as designated by the manufacturer, even when the switch is still positioned for manual operation.~~
- (7) (remaining text unchanged)

**TABLE 1201.1
REFERENCED STANDARDS**

STANDARD NUMBER-YEAR	STANDARD TITLE	REFERENCED SECTION
<u>EPA WaterSense-2021</u>	<u>Specification for Soil Moisture-Based Irrigation Controllers</u>	<u>415.6(1)</u>

(portion of table not shown remains unchanged)

Note: The EPA WaterSense Specifications meet the requirements for mandatory referenced standards in accordance with Section 15.0 of IAPMO’s Regulations Governing Consensus Development of the Water Efficiency and Sanitation Standard.

SUBSTANTIATION:

The language in this section is unclear and duplicative. EPA suggests that the standard require a WaterSense labeled irrigation controller, which can be either a weather-based or soil moisture-based controller that has met EPA’s applicable specification criteria. In particular, requirements in item (1) and item (3) are redundant.

Also, EPA suggests removing item (4), item (5), and item (6). These are inherent requirements for WaterSense labeled irrigation controllers and are therefore redundant to the requirements currently in item (3) which would be included instead in item (1) if other suggested revisions are accepted.

The EPA WaterSense Specifications may be accessed via the following links:

<https://www.epa.gov/system/files/documents/2021-09/ws-outdoor-product-specification-wbic-revised-v1.1.pdf>

https://www.epa.gov/sites/default/files/2021-02/documents/watersense_specification_for_soil_moisture-based_irrigation_controllers.pdf

COMMITTEE ACTION: REJECT

COMMITTEE STATEMENT:

The proposal is being rejected as a more complete treatment of the subject is required. Furthermore, the Water Efficient Landscaping Task Group has submitted a proposal which is more extensive and includes the same EPA WaterSense Specifications referenced in Item #064.

TOTAL ELIGIBLE TO VOTE: 30

VOTING RESULTS: AFFIRMATIVE: 28 NOT RETURNED: 2 CRAWFORD, WILLIAMS



CODES ADMINISTRATION

Proposals

Item #: 064

WEStand 2023 Section: 415.6, 415.7, 415.10, Table 1201.1

SUBMITTER: Thomas Pape
Chair, WE-Stand Water Efficient Landscaping Task Group

RECOMMENDATION:
Revise text

~~415.6~~**415.8 Irrigation Control Systems.** Where installed as part of an ~~an~~ **landscape**-irrigation system, irrigation control systems shall:

- ~~(1) Automatically adjust the irrigation schedule to respond to plant water needs determined by weather or soil moisture conditions. Be listed to the EPA WaterSense Specification for Weather-Based Irrigation Controllers or the EPA WaterSense Specification for Soil Moisture-Based Irrigation Controllers.~~
- ~~(2) Utilize on-site sensors, either integral or auxiliary, or remote weather data to inhibit or suspend irrigation when adequate soil moisture is present or during rainfall or freezing conditions.~~
- ~~(3) Utilize either one or more on-site sensors or a weather-based irrigation controller listed to the US EPA WaterSense Weather-Based Irrigation Controllers Specification to suspend irrigation when adequate soil moisture is present for plant growth.~~
- ~~(4) Have the capability to program multiple and different run times for each irrigation zone to enable cycling of water applications and durations to mitigate water flowing off of the intended irrigation zone.~~
- ~~(5) Be capable of indicating to the user when it is not receiving a signal or local sensor input.~~
- ~~(6) Be capable of allowing for a manual operation troubleshooting test cycle and shall automatically return to sensor input mode within some period of time as designated by the manufacturer, even when the switch is still positioned for manual operation.~~
- ~~(7)~~ **415.8.1 Posting of Settings.** The site specific settings of the irrigation control system shall be posted at the control system location and be visible at the time of inspection. The posted data, where applicable to the settings of the controller, shall include:
 - (1) Precipitation rate for each zone.
 - (2) Plant evapotranspiration coefficients for each zone.
 - (3) Soil type and basic intake and infiltration rate for each zone.
 - (4) Rain sensor settings.
 - (5) Soil moisture setting.
 - (6) Peak demand schedule including run times for each zone and the number of cycles to mitigate runoff and monthly adjustments or percentage change from peak demand schedule.

~~415.7~~**415.9 Irrigation Flow Sensing System.** (remaining text unchanged)

(renumber remaining sections)

~~415.10~~**415.12 System Performance Requirements.** The ~~landscape~~-irrigation system shall be designed and installed to:

- (1) Prevent irrigation water from runoff out of the irrigation zone.
- (2) Prevent water in the supply-line **drainage**-from draining out between irrigation events.
- (3) Not allow irrigation water to be applied onto or enter non-targeted areas including: adjacent property and vegetation areas, adjacent hydrozones not requiring the irrigation water to meet its irrigation demand, non-vegetative areas, impermeable surfaces, roadways, and structures.

Exception: Landscape features outside of the public right of way such as paved walkways, jogging paths, and golf cart paths, are exempted from this requirement where run off drains into the same hydrozone without puddling.

(renumber remaining sections)

**TABLE 1201.1
REFERENCED STANDARDS**

STANDARD NUMBER-YEAR	STANDARD TITLE	REFERENCED SECTION
EPA WaterSense-2021	Specification for Soil Moisture-Based Irrigation Controllers	415.8(1)

(portion of table not shown remains unchanged)

Note: The EPA WaterSense Specifications for Weather-Based Irrigation Controllers and for Soil Moisture-Based Irrigation Controllers meet the requirements for mandatory referenced standards in accordance with Section 15.0 of IAPMO’s Regulations Governing Consensus Development of the Water Efficiency and Sanitation Standard.

SUBSTANTIATION:

Section 415.8 (Irrigation Control Systems) is being revised and separated for additional clarity on the application of provisions.

The EPA WaterSense Specification for Weather-Based Irrigation Controllers establishes the performance and capability criteria and applies to standalone controllers, add-on devices, and plug-in devices that use current weather data as a basis for scheduling irrigation.

The EPA WaterSense Specification for Soil Moisture-Based Irrigation Controllers establishes the criteria for soil moisture-based irrigation controllers and applies to stand-alone controllers, add-on devices, and plug-in devices that inhibit or allow an irrigation event based on reading from a soil moisture sensor mechanism. For these reasons, the proposed modifications are beneficial to the WE•Stand.

The EPA Specifications may be accessed via the following links:

<https://www.epa.gov/system/files/documents/2021-09/ws-outdoor-product-specification-wbic-revised-v1.1.pdf>

https://www.epa.gov/sites/default/files/2021-02/documents/watersense_specification_for_soil_moisture-based_irrigation_controllers.pdf

COMMITTEE ACTION: ACCEPT AS SUBMITTED

415.8 Irrigation Control Systems. Where installed as part of an irrigation system, irrigation control systems shall:

- (1) Be listed to the EPA WaterSense Specification for Weather-Based Irrigation Controllers or the EPA WaterSense Specification for Soil Moisture-Based Irrigation Controllers.
- (2) Utilize on-site sensor(s), either integral or auxiliary, to inhibit or suspend irrigation during rainfall or freezing conditions.

415.8.1 Posting of Settings. The site specific settings of the irrigation control system shall be posted at the control system location and be visible at the time of inspection. The posted data, where applicable to the settings of the controller, shall include:

- (1) Precipitation rate for each zone.
- (2) Plant evapotranspiration coefficients for each zone.
- (3) Soil type and infiltration rate for each zone.
- (4) Rain sensor settings.
- (5) Soil moisture setting.
- (6) Peak demand schedule including run times for each zone and the number of cycles to mitigate runoff and monthly adjustments or percentage change from peak demand schedule.

415.9 Irrigation Flow Sensing System. (remaining text unchanged)

^a
(renumber remaining sections)

^a
415.12 System Performance Requirements. The irrigation system shall be designed and installed to:

- (1) Prevent irrigation water from runoff out of the irrigation zone.
- (2) Prevent water in the supply-line from draining out between irrigation events.
- (3) Not allow irrigation water to be applied onto or enter non-targeted areas including adjacent property and vegetation areas, adjacent hydrozones not requiring the irrigation water to meet its irrigation demand, non-vegetative areas, impermeable surfaces, roadways, and structures.

Exception: Landscape features outside of the public right of way such as paved walkways, jogging paths, and golf cart paths, are exempted from this requirement where run off drains into the same hydrozone without puddling.

^a
(renumber remaining sections)

**TABLE 1201.1
REFERENCED STANDARDS**

STANDARD NUMBER- YEAR	STANDARD TITLE	REFERENCED SECTION
EPA WaterSense-2021	Specification for Soil Moisture-Based Irrigation Controllers	415.8(1)

(portion of table not shown remains unchanged)

COMMITTEE STATEMENT:

An editorial revision has been made to Section 415.8(2) to indicate that either a single on-site sensor or multiple may be used as a means of control for an irrigation system.

TOTAL ELIGIBLE TO VOTE: 30

VOTING RESULTS: AFFIRMATIVE: 25 NEGATIVE: 3 NOT RETURNED: 2 CRAWFORD, WILLIAMS

EXPLANATION OF NEGATIVE:

KLEIN: I concur with Markus Lenger. Also, apparently the TC had no issues with the reference to EPA WaterSense in this proposal, but we did in a previous one.

LANSING: I also concur with Markus Lenger. The proposal is overly restrictive.

LENGER: On-site sensor may have maintenance issues such as battery replacements etc. AI and other means can be as effective and should not be excluded.



CODES ADMINISTRATION

Proposals

Item #: 065

WEStand 2023 Section: 214.0, 415.8, 415.9, 415.11

SUBMITTER: Thomas Pape
Chair, WE-Stand Water Efficient Landscaping Task Group

RECOMMENDATION:
Revise text

~~415.11~~**415.4.4** ~~Narrow or Irregularly Shaped Landscape Areas.~~ ~~Narrow or irregularly shaped landscape-Vegetated landscapes-areas;~~ less than ~~4 feet (1m)~~ **10 feet (3048 mm)** in any direction across any opposing boundaries shall not be irrigated by any irrigation emission device except sub-surface or low flow emitters ~~with flow rates not to exceed 6.3 gallons (24 L) per hour.~~

(renumber remaining sections)

~~415.8~~**415.10** ~~Low Flow Irrigation.~~ Irrigation zones using low flow ~~irrigation-emitters,~~ ~~with emitter flow rates not to exceed 6.3 gallons (24 L) per hour,~~ shall comply with ASABE/ICC 802 ~~Landscape Irrigation Sprinkler and Emitter Standard~~ and shall be equipped with filters sized according to the manufacturer's recommendation for the specific low flow emitter, and with a pressure regulator installed upstream of the irrigation emission devices as necessary to reduce the operating water pressure ~~meeting in accordance with the~~ manufacturers' equipment requirements.

(renumber remaining sections)

~~415.9~~**415.11** ~~Mulched Planting Areas.~~ Only low flow emitters ~~with flow rates not to exceed 6.3 gallons (24 L) per hour are allowed to shall~~ be installed in irrigated mulched planting areas with vegetation taller than 12 inches (305 mm).

(renumber remaining sections)

214.0 - L -

Low Flow Emitter. Low flow irrigation emission device designed to dissipate water pressure and discharge a small uniform flow or trickle of water at a constant flow rate ~~not exceeding 6.3 gallons (24 L) per hour when operating at 30 psi (207 kPa).~~

SUBSTANTIATION:

The above sections are being modified to remove the phrase "with flow rates not to exceed 6.3 gallons (24 L) per hour" as this language belongs better within the definition for "low flow emitter." Since this flow rate is established in industry standards as the maximum value, it does not need to be repeated wherever "low flow emitter" is mentioned within the WE•Stand.

Furthermore, applying the limitations on irregularly shaped areas of larger size is more protective against overspray and runoff and is consistent with California's statewide landscape regulations. All other revisions are for clarity and allow for continuity with the remaining recommendations developed by this Task Group.

COMMITTEE ACTION: ACCEPT AS SUBMITTED

TOTAL ELIGIBLE TO VOTE: 30

VOTING RESULTS: AFFIRMATIVE: 28 NOT RETURNED: 2 CRAWFORD, WILLIAMS



CODES ADMINISTRATION

Proposals

Item #: 066

WEStand 2023 Section: 415.12

SUBMITTER: Thomas Pape
Chair, WE-Stand Water Efficient Landscaping Task Group

RECOMMENDATION:
Revise text

~~415.12~~**415.19 Irrigation System Inspection and Performance Check Irrigation System Audit.** ~~The irrigation system shall be inspected to verify compliance with the irrigation design in accordance with the following: Prior to final inspection, the irrigation system shall be audited to verify compliance with the approved irrigation design and the provisions of this chapter in accordance with the following:~~

(1) ~~Inspection and performance check~~The audit shall be performed by an independent third party having credentials in accordance with the US EPA WaterSense program or the Authority Having Jurisdiction. Irrigation audits shall not be performed by any person participating in the design or installation of the landscape.

(a) Plants are grouped into hydrozones in accordance with Section 415.4.3.

(2b) Sprinklers shall be are installed as specified with proper spacing and required nozzle.

(3c) Sprinklers shall be activated and visually inspected for covering areas without causing overspray or runoff.

(4d) Valves shall be are installed as specified.

(5e) Drip irrigation systems shall be inspected to verify include the proper valve, pressure regulation, filtering device, location of flush valves, and that the installed emitters comply with the irrigation plan.

(6f) Control system(s) shall be are installed as specified and listed as a US EPA WaterSense labeled controller, and all sensors shall be verified for proper installation and operation.

(7g) The peak demand irrigation schedule(s) shall be are posted near the controller, or the scheduling parameters for the controller shall be listed for each station including cycle and soak times.

(8h) Record drawings of the irrigation system shall be are completed and provided for the irrigation inspection.

(92) The audit An inspection report shall be provided to the property owner or management company. The audit report shall identify deficiencies and identifying problems and what corresponding corrective actions are required.

(renumber remaining sections)

SUBSTANTIATION:

Modifications made to this section are needed to verify compliance of the installed irrigation system. The current list has been reorganized to clarify the intent and purpose of the audit while also correlating with the other submitted Task Group recommendations. For these reasons, the modifications are required.

COMMITTEE ACTION: ACCEPT AS SUBMITTED

TOTAL ELIGIBLE TO VOTE: 30

VOTING RESULTS: AFFIRMATIVE: 28 NOT RETURNED: 2 CRAWFORD, WILLIAMS



CODES ADMINISTRATION

Proposals

Item #: 067

WEStand 2023 Section: 415.13

SUBMITTER: Thomas Pape
Chair, WE-Stand Water Efficient Landscaping Task Group

RECOMMENDATION:
Add new text

415.13 Sloped Areas. Where soil surface rises more than 1 foot (305 mm) per 4 feet (1219 mm) of length, the irrigation zone system average precipitation rate shall not exceed 0.75 inches (19.1 mm) per hour as verified through one of the following methods:

(1) Manufacturer's documentation that the precipitation rate for the installed sprinkler head does not exceed 0.75 inches (19.1 mm) per hour where the sprinkler heads are installed not closer than the specified radius and where the water pressure of the irrigation system is not more than the manufacturer's recommendations.

(2) Catch can test in accordance with the requirements of the Authority Having Jurisdiction and where emitted water volume is measured with a minimum of six catchment containers at random places within the irrigation zone for a minimum of 15 minutes to determine the average precipitation rate, expressed as inches per hour (in/h) (mm/h).

(renumber remaining sections)

SUBSTANTIATION:
Section 415.13 (Sloped Areas) identifies requirements which prevent substantial water waste caused by run-off. Such language also correlates with the plumbing code.

COMMITTEE ACTION: ACCEPT AS SUBMITTED

TOTAL ELIGIBLE TO VOTE: 30

VOTING RESULTS: AFFIRMATIVE: 28 NOT RETURNED: 2 CRAWFORD, WILLIAMS



CODES ADMINISTRATION

Proposals

Item #: 068

WEStand 2023 Section: 415.13.2, Table 1201.1

SUBMITTER: Robert Pickering
Eastern Research Group, Inc.
EPA WaterSense

RECOMMENDATION:
Revise text

415.0 Landscape Irrigation Systems.

415.13 Sprinkler Head Installations. (remaining text unchanged)

415.13.2 Sprinkler Head Pressure Regulation. Sprinkler heads shall utilize pressure regulating devices (as part of irrigation system or integral to the sprinkler **headbody**) to maintain manufacturer’s recommended operating pressure for each sprinkler and nozzle type. [Spray sprinkler bodies with integral pressure regulating devices shall be listed to the US EPA WaterSense Specification for Spray Sprinkler Bodies.](#)

**TABLE 1201.1
REFERENCED STANDARDS**

STANDARD NUMBER-YEAR	STANDARD TITLE	REFERENCED SECTION
<u>EPA WaterSense-2017</u>	<u>Specification for Spray Sprinkler Bodies</u>	<u>415.13.2</u>

(portion of table not shown remains unchanged)

Note: The EPA WaterSense Specification for Spray Sprinkler Bodies meets the requirements for a mandatory referenced standard in accordance with Section 15.0 of IAPMO’s Regulations Governing Consensus Development of the Water Efficiency and Sanitation Standard.

SUBSTANTIATION:

WaterSense published its Specification for Spray Sprinkler Bodies in 2017. The specification requires spray sprinkler bodies to have integral pressure regulation. Per the Appliance Standard Awareness Project, WaterSense labeled spray sprinkler bodies are now required in 10 states, including California.

The suggested language would still permit use of a pressure regulating valve on an irrigation system as a whole instead of WaterSense labeled spray sprinkler bodies, which retains flexibility for the end-user.

The EPA WaterSense Specification for Spray Sprinkler Bodies may be accessed via the following link:
<https://www.epa.gov/sites/default/files/2017-09/documents/ws-products-spec-ssb.pdf>

COMMITTEE ACTION: ACCEPT AS SUBMITTED

TOTAL ELIGIBLE TO VOTE: 30

VOTING RESULTS: AFFIRMATIVE: 28 NOT RETURNED: 2 CRAWFORD, WILLIAMS



CODES ADMINISTRATION

Proposals

Item #: 069

WEStand 2023 Section: 415.14 - 415.15, Table 1201.1

SUBMITTER: Thomas Pape
Chair, WE-Stand Water Efficient Landscaping Task Group

RECOMMENDATION:
Revise text

~~415.14 Sprinklers. Sprinklers shall not be installed within 24 inches (610 mm) of any non-permeable surface. Extenders over paved areas shall not be used to irrigate shrubs.~~

~~Exception: Adjacent non-permeable surfaces which are designed and constructed to drain entirely to landscaping.~~

~~415.13-415.14.1 Sprinkler Head Installations.~~ (remaining text unchanged)

~~415.13-415.14.1.1 Sprinkler Heads in Common Irrigation Zones.~~ Sprinkler heads installed in irrigation zones served by a common valve shall be limited to applying water to plants with similar irrigation needs, and shall have matched precipitation rates (identical inches of water application per hour as rated or tested plus or minus 75 percent as labeled or declared in manufacturer's published performance data).

~~415.13-2415.14.1.2 Sprinkler Head Pressure Regulation.~~ Sprinkler heads shall utilize pressure regulating devices (as part of an irrigation system or integral to the sprinkler head-body) to maintain the manufacturer's recommended operating pressure for each sprinkler and nozzle type. Spray sprinkler bodies with integral pressure regulation shall be listed to the EPA WaterSense Specification for Spray Sprinkler Bodies.

~~415.13-3415.14.1.3 Pop-up Type Sprinkler Heads.~~ Where pop-up type sprinkler heads are installed, the sprinkler heads shall pop-up to a height above vegetation level and of not less than 4 inches (102 mm) above the soil level when emitting water.

~~415.13-4415.14.1.4 Sprinkler Head Maximum Precipitation Rate.~~ (remaining text unchanged)

~~415.14-415.15 Outside Hose Bibbs.~~ (remaining text unchanged)

(renumber remaining sections)

**TABLE 1201.1
REFERENCED STANDARDS**

STANDARD NUMBER-YEAR	STANDARD TITLE	REFERENCED SECTION
<u>EPA WaterSense-2017</u>	<u>Specification for Spray Sprinkler Bodies</u>	<u>415.14.1.2</u>

(portion of table not shown remains unchanged)

Note: The EPA WaterSense Specification for Spray Sprinkler Bodies meets the requirements for a mandatory referenced standard in accordance with Section 15.0 of IAPMO's Regulations Governing Consensus Development of the Water Efficiency and Sanitation Standard.

SUBSTANTIATION:

The proposed revisions comply with state and local ordinances and prevent overspray onto non-permeable surfaces from closely installed spray heads. Additionally, the required distance from non-permeable surfaces also assists with avoiding damage to sprinkler heads. EPA WaterSense Specification for Spray Sprinkler Bodies has been added as it establishes water efficiency and performance criteria for sprinkler bodies. For these reasons, the proposed modifications are necessary and improve the WE•Stand.

The EPA WaterSense Specification for Spray Sprinkler Bodies may be accessed via the following link:
<https://www.epa.gov/sites/default/files/2017-09/documents/ws-products-spec-ssb.pdf>

COMMITTEE ACTION: ACCEPT AS SUBMITTED

TOTAL ELIGIBLE TO VOTE: 30

VOTING RESULTS: AFFIRMATIVE: 28 NOT RETURNED: 2 CRAWFORD, WILLIAMS



CODES ADMINISTRATION

Proposals

Item #: 070

WEStand 2023 Section: 415.16

SUBMITTER: Thomas Pape
Chair, WE-Stand Water Efficient Landscaping Task Group

RECOMMENDATION:
Add new text

415.16 Irrigation Zone Performance Criteria. Irrigation zones shall be designed and installed to ensure the average precipitation rate of the sprinkler heads over the irrigated area does not exceed 1 inch per hour (in/h) (25.4 mm/h) as verified through either of the following methods:
(1) Manufacturer's documentation that the precipitation rate for the installed sprinkler head does not exceed 1 inch per hour (in/h) (25.4 mm/h) where the sprinkler heads are installed not closer than the specified radius and where the water pressure of the irrigation system is not more than the manufacturer's recommendations.
(2) Catch can test where emitted water volume is measured with a minimum of six catchment containers at random places within the irrigation zone for a minimum of 15 minutes to determine the average precipitation rate, expressed as inches per hour (in/h) (mm/h).

(renumber remaining sections)

SUBSTANTIATION:
The proposed language correlates with the provisions of the plumbing code. The requirements for manufacturer's documentation and catch can testing are similar to the layout of provisions for sloped areas. Such language strengthens the WE-Stand and ensures verification of established criteria for irrigation zone performance.

COMMITTEE ACTION: ACCEPT AS SUBMITTED

TOTAL ELIGIBLE TO VOTE: 30

VOTING RESULTS: AFFIRMATIVE: 28 NOT RETURNED: 2 CRAWFORD, WILLIAMS



CODES ADMINISTRATION

Proposals

Item #: 071

WEStand 2023 Section: 415.15 - 415.15.1

SUBMITTER: Thomas Pape
Chair, WE-Stand Water Efficient Landscaping Task Group

RECOMMENDATION:
Revise text

~~415.15~~**415.17** **Depth of Irrigation Pipe.** Irrigation pipe downstream from the backflow preventer shall be buried at a minimum depth according to Section ~~415.15.14~~**415.17.1** and Section ~~415.15.24~~**415.17.2**. Irrigation piping shall not be installed below sewage piping.

~~415.15.14~~**415.17.1 Landscape-Irrigated Areas.** Irrigated ~~landscaped~~ areas not exceeding 10 000 square feet (929 m²) shall have irrigation main lines buried a minimum of 12 inches (305 mm) and irrigation lateral lines buried a minimum of 8 inches (203 mm). Irrigated landscaped areas greater than 10 000 square feet (929 m²) shall have irrigation main lines buried a minimum of 18 inches (457 mm) and irrigation lateral lines buried a minimum of 12 inches (305 mm).

(renumber remaining sections)

SUBSTANTIATION:
Section 415.17 is being revised to clarify that irrigation piping should not be installed below sewage piping. Additionally, the phrase "landscape areas" is being changed to "irrigated areas" as the provisions of the main section are applicable to irrigation piping.

COMMITTEE ACTION: ACCEPT AS SUBMITTED

(Below section is shown for information purposes only)

415.15.2 Vehicular Surfaces. Irrigation pipe installed under vehicular paving and pervious pavers, including landscaped fire lanes, shall be sleeved with a minimum of one 1-inch pipe (25 mm) size greater than the irrigation pipe and buried at a minimum depth of 24 inches (610 mm) in all cases.

COMMITTEE STATEMENT:
Per request by the Technical Committee, Section 415.15.2 is being shown for information purposes.

TOTAL ELIGIBLE TO VOTE: 30

VOTING RESULTS: AFFIRMATIVE: 28 NOT RETURNED: 2 CRAWFORD, WILLIAMS



CODES ADMINISTRATION

Proposals

Item #: 072

WEStand 2023 Section: 415.17

SUBMITTER: Edward R. Osann
Natural Resources Defense Council

RECOMMENDATION:
Add new text

415.0 Landscape Irrigation Systems.

415.17 Stormwater Management and Rainwater Retention. Landscapes and structures shall be designed to include rainwater capture and stormwater infiltration capacity sufficient to prevent stormwater from either the 1 inch (25.4 mm) 24-hour rain event or the 85th percentile, 24-hour rain event from leaving the landscape. The location, installation details, and 24-hour retention or infiltration capacity of any stormwater management feature shall be included in the landscape plan and shall be readily accessible onsite to the Authority Having Jurisdiction at the time of inspection.

SUBSTANTIATION:

Preventing excessive stormwater runoff is a major objective for both land use agencies and water management officials. Rainwater retention and stormwater treatment systems under Chapters 8 and 9 are alternate water sources that can support non-potable uses of water without further burdening public water supplies. Stormwater management features can also assist in recharging groundwater to help stabilize water tables and build supplies for potential withdrawal and reuse, as well as protecting water quality and natural watercourses.

This proposal would establish a minimum standard for on-site retention of stormwater. Local or regional regulations may supplement this minimum standard with more stringent requirements if necessary to achieve water quality standards or other regulatory objectives.

COMMITTEE ACTION: ACCEPT AS SUBMITTED

TOTAL ELIGIBLE TO VOTE: 30

VOTING RESULTS: AFFIRMATIVE: 28 NOT RETURNED: 2 CRAWFORD, WILLIAMS



Proposals

Item #: 073

WEStand 2023 Section: 418.2, 418.4, Chapter 10, Table 1201.1

SUBMITTER: Emily Toto
ASHRAE

RECOMMENDATION:
Revise text

418.0 Swimming Pools, Spas, and Hot Tubs.

418.2 On and Off Switch Pool Heaters. Pool, ~~spa, and hot tub~~ heaters shall be equipped with a readily accessible on and off switch to allow shutting off the heater without adjusting the thermostat setting. Pool heaters fired by natural gas shall not have continuously burning pilot lights. [ASHRAE 90.1:7.4.5.1]

418.4 Time Switches. Time switches shall be installed on swimming pool, ~~spa, and hot tub~~ heaters and pumps.

Exceptions:

- (1) Where public health standards require 24-hour pump operation.
- (2) Where pumps are required to operate solar and waste heat recovery pool heating systems. [ASHRAE 90.1:7.4.5.3]

1002.0 Recirculation Systems.

1002.1 Pump Operation.

1002.1.2 For Pumps Between Boilers and Storage Tanks Circulating Pump Controls. When used to maintain storage tank water temperature, recirculating pumps shall be equipped with controls limiting operation to a period from the start of the heating cycle to a maximum of 5 minutes after the end of the heating cycle. [ASHRAE 90.1:7.4.4.4]

1002.3 Temperature Maintenance Controls. ~~For other than low-rise residential buildings, s~~Systems designed to maintain usage temperatures in hot-water pipes, such as recirculating hot-water systems or heat trace, shall be equipped with automatic time switches or other controls that can be set to switch off the usage temperature maintenance system during extended periods when hot water is not required. [ASHRAE 90.1:7.4.4.2]

1004.0 Service Hot Water – Other Than Low-Rise Residential Buildings.

1004.2 New Buildings. Service water heating systems and equipment shall comply with ~~the requirements of this section as described in~~ Section 1004.5 ~~and Section 1004.6.~~ [ASHRAE 90.1:7.1.1-17.1.2]

1004.3 Additions to Existing Buildings. Service water heating systems and equipment shall comply with ~~the requirements of this section~~ ~~Section 1004.5 and Section 1004.6.~~

Exception: When the service water heating to an addition is provided by existing service water heating systems and equipment, such systems and equipment shall not be required to comply with this standard. However, any new systems or equipment installed must comply with specific requirements applicable to those systems and equipment. [ASHRAE 90.1:7.1.1-27.1.3]

1004.4 Alterations to Existing Buildings Service Water-Heating Systems and Equipment. Building service water heating equipment installed as a direct replacement for existing building service water heating equipment shall comply with the requirements of Section 1004.0 applicable to the equipment being replaced. New and replacement piping shall comply with ~~Section 1005.2 and~~ Section 1005.3.

Exception: Compliance shall not be required where there is insufficient space or access to meet these requirements. [ASHRAE 90.1:7.1.1-37.1.4]

1004.5 Requirements for Compliance Path(s). ~~Compliance shall be achieved by meeting the requirements of Section 1004.1, General; Section 1005.0, Mandatory Provisions; Section 1006.0, Prescriptive Path; and Section 1007.0;~~

~~Submittals: Service water-heating systems and equipment shall comply with Section 1004.0, Section 1005.0, and Section 1007.0 of this code, and Section 7.8 of ASHRAE 90.1. [ASHRAE 90.1:7.2.1]~~

1004.6 Energy Cost Budget Method. Projects using the Energy Cost Budget Method ~~in accordance with~~ (Section 11 of ASHRAE 90.1) ~~for demonstrating compliance with the standard~~ shall also comply with Section 1006.0 of this code meet the requirements of Section 1005.0, Mandatory Provisions, in conjunction with Section 11 of ASHRAE 90.1, Energy Cost Budget Method. [ASHRAE 90.1:7.2.2]

1005.0 Mandatory Provisions.

1005.1 Load Calculations. Service water-heating system design loads for the purpose of sizing systems and equipment shall be determined in accordance with manufacturers' published sizing guidelines or generally accepted engineering standards and handbooks acceptable to the adopting authority (e.g., ASHRAE Handbook – HVAC Applications). [ASHRAE 90.1:7.4.1]

1005.2 Equipment Efficiency. Water-heating equipment, hot-water supply boilers used solely for heating potable water, pool heaters, and hot-water storage tanks shall meet the criteria listed in Table 1005.2. Where multiple criteria are listed, all criteria shall be met. Omission of minimum performance requirements for certain classes of equipment does not preclude use of such equipment where appropriate. Equipment not listed in Table 1005.2 has no minimum performance requirements.

Exceptions: Water heaters and hot-water supply boilers having more than 140 gallons (530 L) of storage capacity are not required to meet the standby loss (*SL*) requirements of Table 1005.2 when all of the following criteria are met:

- (1) The tank surface is thermally insulated to R-12.5-;
- (2) A standing pilot light is not installed-; and
- (3) Gas- or oil-fired storage water heaters have a flue damper or fan-assisted combustion. [ASHRAE 90.1:7.4.2]

1005.5 Service Water-Heating System Controls.

1005.5.1 Storage Temperature Controls. Temperature controls shall be provided that allow for storage temperature adjustment from 120°F (49°C) or lower to a maximum temperature compatible with the intended use.

Exception: When the manufacturers' installation instructions specify a higher minimum thermostat setting to minimize condensation and resulting corrosion. [ASHRAE 90.1:7.4.4.1]

1005.6 Heat Traps. Vertical pipe risers serving storage water heaters and storage tanks not having integral heat traps and serving a nonrecirculating system shall have heat traps on both the inlet and outlet piping as close as practical to the storage tank. A heat trap is a means to counteract the natural convection of heated water in a vertical pipe run. The means ~~shall be is~~ either of the following:

- (1) ~~A~~ device specifically designed for the purpose or an arrangement of tubing that forms a loop of 360 degrees (6.28 rad), or
- (2) ~~P~~ piping that from the point of connection to the water heater (inlet or outlet) includes a length of piping directed downward before connection to the vertical piping of the supply water or hot-water distribution system, as applicable. [ASHRAE 90.1:7.4.6]

1006.0 Prescriptive Path.

1006.1 Space Heating and Service Water-Heating. The use of a gas-fired or oil-fired space-heating boiler system otherwise complying with Section 1004.0 to provide the total space heating and service water-heating for a building is allowed when one of the following conditions is met:

- (1) The single space-heating boiler, or the component of a modular or multiple boiler system that is heating the service water, has a standby loss in Btu/h (kW) not exceeding $(13.3 \times pmd + 400)/h$, where (*pmd*) is the probable maximum demand in gallons per hour (*gph*), (*L/h*), determined in accordance with the procedures described in generally accepted engineering standards and handbooks, and (*n*) is the fraction of the year when the outdoor daily mean temperature is greater than 64.9°F (18.28°C). The standby loss ~~is to shall~~ be determined for a test period of 24 hours duration while maintaining a boiler water temperature of at least 90°F (50°C) above ambient, with an ambient temperature between 60°F (16°C) and 90°F (32°C). For a boiler with a modulating burner, this test shall be conducted at the lowest input.
- (2) It is demonstrated to the satisfaction of the Authority Having Jurisdiction that the use of a single heat source will consume less energy than separate units.
- (3) The energy input of the combined boiler and water heater system is less than 150 000 Btu/h (44 kW). [ASHRAE 90.1:7.5.1]

1006.2 Service Water-Heating Equipment. Service water-heating equipment used to provide the additional function of space heating as part of a combination (integrated) system shall satisfy all stated requirements for the service water-heating equipment. [ASHRAE 90.1:7.5.2]

1006.3 Heat Recovery for Service Water-Heating.

1006.3.1 Condenser. Condenser heat recovery systems shall be installed for heating or preheating of service hot water provided all of the following are true:

- (1) The facility operates 24 hours a day.
- (2) The total installed heat-rejection capacity of the water-cooled systems exceeds 6 000 000 Btu/h (1758 kW) of heat

rejection.

(3) The design service water heating load exceeds 1 000 000 Btu/h (293 kW).

[ASHRAE 90.1:6.5.6.2.1]

1006.3.2 Capacity. The required heat recovery system shall have the capacity to provide the ~~smaller~~ lesser of the following:

(1) Sixty percent of the peak heat rejection load at design conditions, ~~or~~ or

(2) Preheat of the peak service hot water draw to 85°F (29°C). [ASHRAE 90.1:6.5.6.2.2]

Exceptions:

(a) Facilities that employ condenser heat recovery for space heating with a heat recovery design exceeding 30 percent of the peak water-cooled condenser load at design conditions.

(b) Facilities that provide 60 percent of their service water heating from on-site renewable energy site-solar or site-recovered energy or from other sources.

TABLE 1005.2
PERFORMANCE REQUIREMENTS FOR WATER HEATING EQUIPMENT - MINIMUM EFFICIENCY REQUIREMENTS
 [ASHRAE 90.1: TABLE 7.8]

EQUIPMENT TYPE	SIZE CATEGORY (INPUT)	SUBCATEGORY OR RATING CONDITION	PERFORMANCE REQUIRED ¹	TEST PROCEDURE ^{2,3}
Electric Table-Top <u>Water Heaters</u>	<=12 kW	Resistance <4000 (Btu/h)/gal >=20 gal and <=120 gal	See footnote 7	<u>10 CFR 430 Appendix E</u>
Electric <u>storage</u> water heaters	<=12 kW ⁵	Resistance <4000 (Btu/h)/gal >=20 gal and <=55 gal	See footnote 7	<u>10 CFR 430 Appendix E</u>
		<4000 (Btu/h)/gal >55 gal and <=120 gal	<u>See footnote 7</u>	<u>10 CFR 430 Appendix E</u>
	>12 kW ⁵	Resistance =20 gal <4000 (Btu/h)/gal	<u>SL <= 0.3 + 27/V_m %/h</u>	Section G.2 of ANSI Z21.10.3 <u>10 CFR 431.106</u>
	<=24 Amps and <=250 Volts	<u>Heat Pump</u>	<u>See footnote 7</u>	-
Electric <u>instantaneous</u> water heaters	<u><=12 kW</u>	<u>>=4000 (Btu/h)/gal</u> <u><2 gal</u>	<u>See footnote 7</u>	<u>10 CFR 430 Appendix E</u>
	<u>>12 kW and</u> <u><=58.6 kW³</u>	<u>>=4000 (Btu/h)/gal</u> <u><=2 gal</u> <u><=180°F</u>	<u>Very Small DP: UEF = 0.80</u> <u>Low DP: UEF = 0.80</u> <u>Medium DP: UEF = 0.80</u> <u>High DP: UEF = 0.80</u>	<u>10 CFR 430 Appendix E</u>
	<u>>58.6 kW³</u>	<u>>=4000 (Btu/h)/gal</u> <u><10 gal</u>	<u>No requirement</u>	-
		<u>>=4000 (Btu/h)/gal</u> <u>>=10 gal</u>	<u>No requirement</u>	-
Gas storage water heaters	<=75 000 Btu/h	<4000 (Btu/h)/gal >=20 gal and <=55 gal	See footnote 7	<u>10 CFR 430 Appendix E</u>
		<4000 (Btu/h)/gal >55 gal and <=100 gal	<u>See footnote 7</u>	<u>10 CFR 430 Appendix E</u>
	<u>>75 000 Btu/h⁶ and</u> <u><=105 000 Btu/h⁴</u>	<u><4000 (Btu/h)/gal</u> <u><=120 gal</u> <u><=180°F</u>	<u>80% E_t (Q/800 + 100vV)SL, Btu/h</u> <u>Very Small DP:</u> <u>UEF = 0.2674 - (0.0009 × V_r).</u> <u>Low DP:</u> <u>UEF = 0.5362 - (0.0012 × V_r).</u> <u>Medium DP:</u> <u>UEF = 0.6002 - (0.0011 × V_r).</u> <u>High DP:</u> <u>UEF = 0.6597 - (0.0009 × V_r).</u>	<u>10 CFR 430 Appendix E</u> <u>Sections G.1 and G.2 of ANSI Z21.10.3</u>

	$>105\,000\text{ Btu/h}^{4,6}$	$<4000\text{ (Btu/h)/gal}$	$80\% E_t$ $SL \leq (Q/800 + 110vV),$ Btu/h	10 CFR 431.106
Gas instantaneous water heaters	$>50\,000\text{ Btu/h}$ and $\leq 200\,000\text{ Btu/h}$	$\geq 4000\text{ (Btu/h)/gal}$ and $< 2\text{ gal}$	See footnote 7	10 CFR 430 Appendix E
	$\geq 200\,000\text{ Btu/h}^{4,6}$	$\geq 4000\text{ (Btu/h)/gal}$ and $< 10\text{ gal}$	$80\% E_t$	10 CFR 431.106 Sections G.1 and G.2 of ANSI Z21.10.3
	$\geq 200\,000\text{ Btu/h}^6$	$\geq 4000\text{ (Btu/h)/gal}$ and $\geq 10\text{ gal}$	$80\% E_t$ $SL \leq (Q/800 + 100vV)SL,$ Btu/h	
Oil storage water heaters	$\leq 105\,000\text{ Btu/h}$	$= 20\text{ gal}$ $< 4000\text{ (Btu/h)/gal}$ $\leq 50\text{ gal}$	See footnote 7	10 CFR 430 Appendix E
	$\geq 105\,000\text{ Btu/h}$ and $\leq 140\,000\text{ Btu/h}^5$	$< 4000\text{ (Btu/h)/gal}$ $\leq 120\text{ gal}$ $< 4000\text{ (Btu/h)/gal}$ $\leq 180^\circ\text{F}$	$80\% E_t (Q/800 + 100vV)SL, \text{Btu/h}$ Very Small DP: $UEF = 0.2932 - (0.0015 \times V_f)$ Low DP: $UEF = 0.5596 - (0.0018 \times V_f)$ Medium DP: $UEF = 0.6194 - (0.0016 \times V_f)$ High DP: $UEF = 0.6740 - (0.0013 \times V_f)$	10 CFR 430 Appendix E Sections G.1 and G.2 of ANSI Z21.10.3
	$> 140\,000\text{ Btu/h}$	$< 4000\text{ (Btu/h)/gal}$	$80\% E_t$ $SL \leq (Q/800 + 100vV),$ Btu/h	10 CFR 431.106
Oil instantaneous water heaters	$\leq 210\,000\text{ Btu/h}$	$\geq 4000\text{ (Btu/h)/gal}$ and $< 2\text{ gal}$	See footnote 7 $80\% E_t$ $EF \geq 0.59 - 0.0005 \times V$	10 CFR 430 Appendix E as it appeared as of 1/1/2014
	$> 210\,000\text{ Btu/h}$	$\geq 4000\text{ (Btu/h)/gal}$ and $< 10\text{ gal}$	$80\% E_t$	10 CFR 431.106 Sections G.1 and G.2 of ANSI Z21.10.3
	$> 210\,000\text{ Btu/h}$	$\geq 4000\text{ (Btu/h)/gal}$ and $\geq 10\text{ gal}$	$78\% E_t$ $SL \leq (Q/800 + 100vV)SL,$ Btu/h	
Hot-water supply boilers, gas and oil ⁶	$\geq 300\,000\text{ Btu/h}$ and $\leq 12\,500\,000\text{ Btu/h}$	$\geq 4000\text{ (Btu/h)/gal}$ and $< 10\text{ gal}$	$80\% E_t$	
Hot-water supply boilers, gas ⁶	$\geq 300\,000\text{ Btu/h}$ and $\leq 12\,500\,000\text{ Btu/h}$	$\geq 4000\text{ (Btu/h)/gal}$ and $\geq 10\text{ gal}$	$80\% E_t$ $SL \leq (Q/800 + 100vV)SL,$ Btu/h	10 CFR 431.106 Sections G.1 and G.2 of ANSI Z21.10.3
Hot-water supply boilers, oil	$\geq 300\,000\text{ Btu/h}$ and $\leq 12\,500\,000\text{ Btu/h}$	$\geq 4000\text{ (Btu/h)/gal}$ and $\geq 10\text{ gal}$	$78\% E_t$ $SL \leq (Q/800 + 100vV)SL,$ Btu/h	
Pool heaters, oil and gas	All	—	See footnote 7	ASHRAE 146 10 CFR 430 Appendix P
Heat pump pool heaters	All	50°F db 44.2°F wb outdoor air 80.0°F entering water	4.0 COP	AHRI 1160 10 CFR 430 Appendix P
Unfired storage tanks	All		R-12.5	(none)

For SI units: 1 gallon = 3.785 L, 1000 British thermal units per hour = 0.293 kW, $^\circ\text{C} = (^\circ\text{F} - 32)/1.8$

Notes:

¹ Thermal efficiency (E_t) is a minimum requirement, while standby loss (SL) is a maximum requirement Btu/h based on a 70°F temperature difference between stored water and ambient requirements. In the SL equation, V is the rated volume in gallons (gal)(L) and Q is the nameplate input rate in Btu/h (kW). V_m is the measured volume in the tank in gallons (gal)(L). Standby loss for electric water heaters is in terms of %/h and denoted by the term “S,” and standby loss for gas and oil water heaters is in terms of Btu/h (kW) and denoted by the term “SL.” Draw pattern (DP) refers to the water draw profile in the Uniform Energy Factor (UEF) test. UEF and Energy Factor (EF) are minimum requirements. In the UEF standard equations, V_r refers to the rated volume in gallons (gal)(L).

² ASHRAE 90.1 Section 12 contains a complete specification, including the year version, of the referenced test procedure.

~~³ Section G1 is titled “Test Method for Measuring Thermal Efficiency” and Section G2 is titled “Test Method for Measuring Standby Loss.”~~

~~⁴³ Electric instantaneous water heaters with input rates below 200 000 Btu/h (58.6 kW) must capacities greater than 40 000 Btu/h (12 kW) and less than or equal to 200 000 Btu/h (58.6 kW) shall comply with these the requirements for 200 000 Btu/h (58.6 kW) if the water heater meets one of the following conditions:~~

- ~~(1) Has a storage volume greater than 2 gallons (7.6 L),~~
- ~~(2) Is designed to heat provide outlet hot water at temperatures of greater than 180°F (82°C), or~~
- ~~(3) higher Uses three-phase power.~~

~~⁵⁴ Electric Gas storage water heaters with input rates less than 40 946 Btu/h (12 kW) shall be in accordance capacities greater than 75 000 Btu/h (22 kW) and less than or equal to 105 000 Btu/h (31 kW) shall comply with these the requirements where for greater than 105 000 Btu/h (31 kW) if the water heater meets one of the following conditions:~~

- ~~(1) Has a storage volume greater than 120 gallons (454 L);~~
- ~~(2) Is designed to heat provide outlet hot water at temperatures of greater than 180°F (82°C), or~~
- ~~(3) higher Uses three-phase power.~~

~~⁵ Oil storage water heaters with input capacities greater than 105 000 Btu/h (31 kW) and less than or equal to 140 000 Btu/h (41 kW) must comply with the requirements for greater than 140 000 Btu/h (41 kW) if the water heater meets one of the following conditions:~~

- ~~(1) Has a storage volume greater than 120 gallons (454 L);~~
- ~~(2) Is designed to provide outlet hot water at temperatures greater than 180°F (82°C); or~~
- ~~(3) Uses three-phase power~~

⁶ Refer to Section 7.5.3 of ASHRAE 90.1 Section 7.5.3 for additional requirements for gas storage and instantaneous water heaters and gas hot-water supply boilers.

⁷ ~~In the U.S., the efficiency requirements for w~~ater heaters or gas pool heaters in this category or subcategory are specified regulated as consumer products by the U.S. Department of Energy (USDOE) as defined. ~~These requirements and applicable test procedures are found~~ in the Code of Federal Regulations 10 CFR Part 430. **Informative Note:** See ASHRAE 90.1 Informative Appendix F for the U.S. Department of Energy efficiency requirements applicable to these water heaters and pool heaters.

**TABLE 1201.1
REFERENCED STANDARDS**

STANDARD NUMBER-YEAR	STANDARD TITLE	REFERENCED SECTION
CFR 10, 430, Subpart B 10 CFR 430	Energy Conservation Program for Consumer Products- Test Procedures	Table 1005.2
10 CFR 431.106	Uniform Test Method for the Measurement of Energy Efficiency of Commercial Water Heating Equipment	Table 1005.2

(portion of table not shown remains unchanged)

Note: 10 CFR 430, 10 CFR 431.106, and ASHRAE 90.1 meet the requirements for mandatory referenced standards in accordance with Section 15.0 of IAPMO’s Regulations Governing Consensus Development of the Water Efficiency and Sanitation Standard.

SUBSTANTIATION:

The above section is being revised to correlate with ASHRAE 90.1-2019 (latest version) in accordance with Section 16.0 of the IAPMO Regulations Governing Consensus Development of the Water Efficiency and Sanitation Standard (Extract Guidelines).

COMMITTEE ACTION: REJECT

COMMITTEE STATEMENT:

There is concern with Section 418.2 and Section 418.4 as the language should reference pools, spas and hot tubs rather than only pools. The ASHRAE definition for "pool" is required to elucidate the applicability of provisions within these sections.

Additionally, there are portions of Table 1005.2 which are being stricken but should remain as they offer needed clarity.

The Technical Committee acknowledges that ASHRAE may also have additional revisions currently being published, requests technical reasonings for the submitted extract updates, and recommends that these concerns be addressed via public comment.

TOTAL ELIGIBLE TO VOTE: 30

VOTING RESULTS: AFFIRMATIVE: 28 NOT RETURNED: 2 CRAWFORD, WILLIAMS



Proposals

Item #: 074

WEStand 2023 Section: Chapter 5, Appendix C

SUBMITTER: Jim Kendzel
Chair, WE-Stand Premise Water Supply System Design Task Group

RECOMMENDATION:
Revise text

CHAPTER 5 **PEAK WATER DEMAND CALCULATOR**

G-101-0501.0 General.

G-101-1501.1 **Applicability.** ~~This appendix provides a~~ The provisions of this chapter shall establish the method for estimating the supply demand load for the building water supply and principal branches and risers for new construction of single- and multi-family dwellings ~~with water-conserving plumbing fixtures, fixture fittings, and appliances.~~ The plumbing code shall be used for all other occupancies.

Note: The requirements listed in this chapter are based on the technical paper entitled "Peak Water Demand Study." Both the Water Demand Calculator and a copy of this technical paper are available for download at: <https://www.iapmo.org/water-demand-calculator/>.

G-102-0502.0 Demand Load.

G-102-2502.1 **Water Demand Calculator.** The estimated supply demand design flow rate for the building supply and principal branches and risers shall be determined by the IAPMO Water Demand Calculator, ~~available for download at: www.iapmo.org/Water-Demand-Calculator/~~

G-102-1502.1.1 **Water-Conserving Fixtures.** The flow rates for plumbing fixtures, fixture fittings, and appliances shall not exceed the design flow rates in Table G-102-1502.1.1.

G-102-6502.1.2 **Other Fixtures.** Indoor fixtures, fixture fittings, and appliances not ~~included specified~~ in Table G-102-1502.1.1 shall be added in Rows 12 through 14 in the Water Demand Calculator as Other Fixtures. The probability of use and flow rate for Other Fixtures shall be added by selecting a comparable probability of use and design flow rate from ~~Columns {C} and {E}~~ the Water Demand Calculator.

502.2 **Supply Demand.** The supply demand flow rate shall be determined in accordance with Section 502.2.1 and Section 502.2.2.

G-102-3502.2.1 **Meter and Building Supply.** To determine the design supply demand flow rate for the water meter and building supply, enter the total number of each indoor plumbing fixtures and appliances for the building into ~~Column {B}~~ of the Water Demand Calculator and run the Calculator. (See ~~Table G-102.3 for an example~~ Figure 502.2.1.)

TABLE C-102.1502.1.1
MAXIMUM DESIGN FLOW RATE FOR WATER-CONSERVING
PLUMBING FIXTURES, FIXTURE FITTINGS, AND APPLIANCES IN
RESIDENTIAL OCCUPANCIES

FIXTURE AND APPLIANCE	MAXIMUM DESIGN FLOW RATE (gallons per minute)
Bar Sink	1.5
Bathtubs ²	5.5
Bidet	2.0
Clothes Washer ¹	3.5
Combination Bath/Shower	5.5
Dishwasher ¹	1.3
Kitchen Faucet	2.2
Laundry Faucet (with aerator)	2.0
Lavatory Faucet	1.5
Shower, per head	2.0
Water Closet, 1.28 GPF Gravity Tank	3.0
<u>Other fixtures</u>	<u>6.0</u>

For SI units: 1 gallon per minute = 0.06 L/s

¹ Clothes washers and dishwashers shall have an eEnergy sStar label.

² Including whirlpools and similar fixtures.

Water Demand Calculator (WDC v2.1)

PROJECT NAME :
 Click for Drop-down Menu →

Friday, January 21, 2022
9:30 AM

FIXTURE GROUPS	FIXTURE	ENTER TOTAL NUMBER OF FIXTURES	PROBABILITY OF USE (%)	ENTER FIXTURE FLOW RATE (GPM)	MAXIMUM RECOMMENDED FIXTURE FLOW RATE (GPM)
Bathroom Fixtures	1 Bathtub (no Shower)	0	1.00	5.5	5.5
	2 Bidet	0	1.00	2.0	2.0
	3 Combination Bath/Shower	0	5.50	5.5	5.5
	4 Faucet, Lavatory	0	2.00	1.5	1.5
	5 Shower, per head (no Bathtub)	0	4.50	2.0	2.0
	6 Water Closet, 1.28 GPF Gravity Tank	0	1.00	3.0	3.0
Kitchen Fixtures	7 Dishwasher	0	0.50	1.3	1.3
	8 Faucet, Kitchen Sink	0	2.00	2.2	2.2
Laundry Room Fixtures	9 Clothes Washer	0	5.50	3.5	3.5
	10 Faucet, Laundry	0	2.00	2.0	2.0
Bar/Prep Fixtures	11 Faucet, Bar Sink	0	2.00	1.5	1.5
Other Fixtures	12 Fixture 1	0	0.00	0.0	6.0
	13 Fixture 2	0	0.00	0.0	6.0
	14 Fixture 3	0	0.00	0.0	6.0

COMPUTED RESULTS FOR PEAK PERIOD CONDITIONS

Total No. of Fixtures in Calculation

99th Percentile Demand Flow

Hunter Number

Stagnation Probability

↓ Select Units for Water Demand ↓

FIGURE 502.2.1
WATER DEMAND CALCULATOR

TABLE C-102.3
WATER DEMAND CALCULATOR EXAMPLE

(remove table in its entirety)

~~C-102-4502.2.2 Fixture Branches and Fixture Supplies-Risers.~~ To determine the design supply demand flow rate for fixture-branches and risers, enter the total number of each plumbing fixtures and appliances ~~s for the fixture on each~~ branch or riser into Column [B] of the Water Demand Calculator and run the Calculator. The flow rate for one fixture branch and one fixture supply shall be the design flow rate of the fixture according to Table ~~C-102-4502.1.1~~.

~~C-102-5502.3 Continuous Supply Demand.~~ The cContinuous supply demands in gallons per minute (gpm) for lawn sprinklers, air conditioners, hose bibbs, etc., shall be added to the total estimated demand for the building supply as determined by Section C-102.3. ~~Where there is more than one hose bibb installed on the plumbing system, the demand for only one hose bibb shall be added to the total estimated demand for the building supply. Where a hose bibb is installed on a fixture branch, the demand of the hose bibb shall be added to the design flow rate for the fixture branch as determined by Section C-102.4~~ determined for the building supply, branches, and risers in accordance with the plumbing code.

Exceptions:

~~(1) Where there is more than one hose bibb installed on the plumbing system, the demand for only one hose bibb shall be added to the total estimated demand for the building supply.~~

~~(2) Where a hose bibb is installed on a principal branch, riser or fixture branch, the demand of the hose bibb shall be added to the design flow rate for the principal branch, riser, or fixture branch as applicable.~~

C-102-7503.0 Size of Water Piping per Appendix A.

~~503.1 General.~~ Except as provided in ~~Section C-102.0~~ for estimating the demand load for single- and multi-family dwellings, ~~the size of each water piping system shall be determined in accordance with the procedure set forth in Appendix A of the 2021 UPC Section 503.2 and Section 503.3, the procedure for sizing the water supply system shall be determined in accordance with the plumbing code.~~

~~503.2 Total Demand Load.~~ The total demand load shall be the sum of the supply demand load calculated in accordance with Section 502.2 and the continuous demand load calculated in accordance with Section 502.3 for the building supply, branches, risers and fixture branches as applicable.

~~503.3 Determining Pipe Diameters.~~ After determining the permissible friction loss per 100 feet (30 480 mm) of pipe and the total demand loads in accordance with ~~Section A-104.0503.2, and the demand flow in accordance with the Water Demand Calculator,~~ the diameter of the building supply pipe, branches and risers shall be obtained from ~~Chart A-105.1(1), Chart A-105.1(2), Chart A-105.1(3), Chart A-105.1(4), Chart A-105.1(5), Chart A-105.1(6), or Chart A-105.1(7) whichever is applicable, in accordance with Section A-105.0 and Section A-106.0. Velocities shall be in accordance with Section A-107.1. Appendix I Installation Standard 31-2014 of the 2021 UPC, Figure 3 and Figure 4 shall be permitted when sizing PEX systems~~ the sizing charts in Appendix C.

(renumber remaining chapters)

SUBSTANTIATION:

This proposal is to move the use of the Water Demand Calculator (WDC), currently in the informative Appendix C of WE•Stand and moving the use of the WDC into the normative section of WE•Stand as Chapter 5. As noted in the proposal, the new mandated requirements are to use the WDC for estimating the demand load for the building water supply and principal branches for single- and multi-family dwellings.

The development of the WDC is documented in the study, Peak Water Demand Study (Buchberger, et.al. 2017. <https://www.iapmo.org/water-demand-calculator/>). The Study concluded, “The computational methods for estimating water supply demand for single and multi-family dwellings identified in this report and coded into the Water Demand Calculator are offered as an improved method to avoid over-design resulting from Hunter’s Curve as the current method used in the U.S. plumbing codes.” The study also concludes that “A key advantage of the Wistort approach is that it does not rely on mysterious fixture units and it is not calibrated to any particular fixture type. Hence, the dimensionless formulation will remain valid even as water use habits change and fixture types evolve in the future.”

Since the publication of the Study and the inclusion of the WDC in an informative Appendix of WE•Stand, a number of states and local jurisdictions have taken the lead in adopting the use of the Water Demand Calculator including: Nevada (2018), North Dakota (2020), Oregon (2021), and the city of Seattle along with King County in Washington (2021).

In November 2021 Gary Klein and Associates, Inc., on behalf of 20 organizations, submitted a Petition to the California Building Standards Commission to adopt the use of the Water Demand Calculator (Petition) in determining the estimated design flow rate.

The following benefits were cited in the Petition:

- Construction cost savings due to:

- Smaller diameter pipes and fittings, valves, pumps, and other equipment,
- Smaller inside diameter pipe insulation, and
- Smaller water service entrance size, resulting in smaller water meter size with lower connection fees.
- Ongoing cost savings due to:
 - Water savings from faster hot water delivery times, resulting in smaller monthly water service charges and lower associated volumetric sewer charges,
 - Energy savings due to decreased heat loss in hot water distribution system, particularly in multifamily buildings with a recirculation system, and
 - Embedded energy savings for the water and wastewater utilities due to customer indoor water savings.
- Reduced public health and safety risks and improved water quality due to shorter water dwell times within plumbing systems. Each floor plan determines the distance between the mechanical room and the fixtures. UPC Appendix M does not change the length of the pipe, only the diameter. With the pipe diameter on each segment reduced, the pipe volume will be reduced.
- Reduced carbon emissions due to material savings and energy reductions.

Figure 1 from the Petition provides a comparison of Actual Peak Flow Rates to calculated rates using the Hunter’s Curve. The figure underscores that the standard practice – based on the Hunter’s curve – overestimates the peak flow rates when compared to use with plumbing fixtures and appliances that have been in buildings since the Energy Policy Act of 1992 went into effect the mid-1990s.

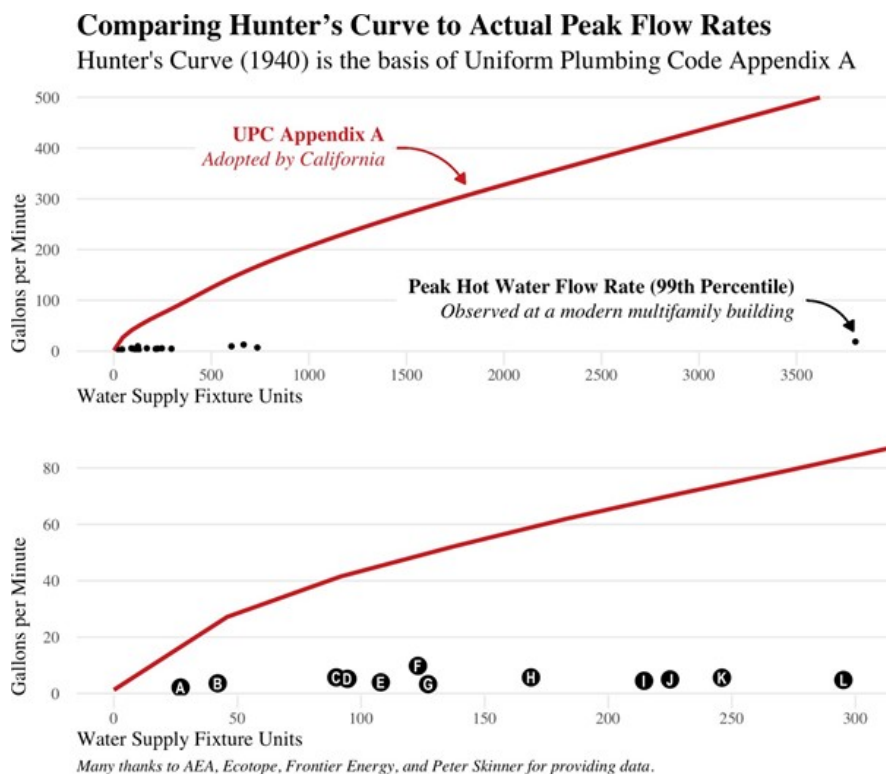
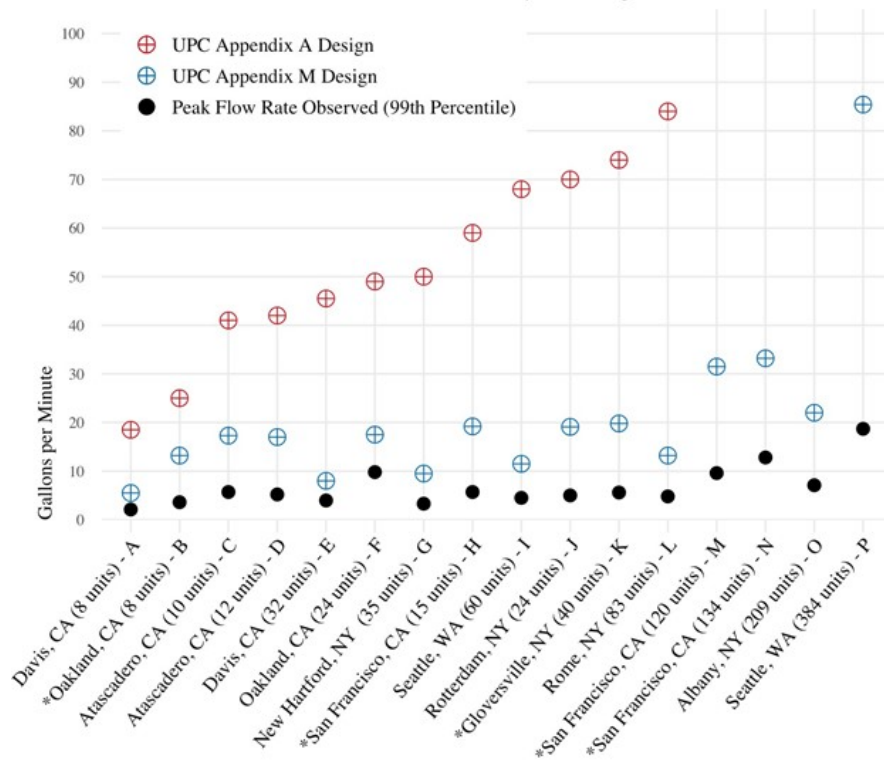

Figure 1: Comparing UPC Appendix A (Hunter’s Curve) to Actual Peak Flow Rates (99th Percentile of non-zero flows for all sampling intervals over the entire monitoring period) in Multifamily Buildings (ranging in size from 8 to 384 apartments). The top graph in Figure 1 shows data for all buildings analyzed to date. The bottom graph in Figure 1 zooms in on the cluster of buildings with fewer than 300 Water Supply Fixture Units (WSFU).

Figure 2 from the Petition compares the monitored data from the 16 multifamily buildings to the peak water demand estimates based on UPC Appendix M. The comparison shows that Water Demand Calculator provides a conservative approach to estimate peak water flow rates, providing a margin of safety at least 1.8 times the measured data in multifamily buildings.

Comparing Design Predictions to Actual Peak Flow Rates

Peak Hot Water Flow Rates in Multifamily Buildings



*Many thanks to AEA, Ecotope, Frontier Energy, and Peter Skinner for providing data.
The observation period for this building was between 7 and 14 days. All others exceeded 14 days.

The WE•Stand Premise Water System Design Task Group fully endorses this proposal based on the significant theoretical work conducted in the development of the Water Demand Calculator followed by the validation of the theory through the comparison of the Water Demand Calculator to actual field peak flow rates.

Additional information on the Water Demand Calculator may be found via the following link:
<https://www.iapmo.org/water-demand-calculator/>

COMMITTEE ACTION: REJECT

COMMITTEE STATEMENT:

The proposal is being rejected as there is concern with referencing the sizing charts located in Appendix C, as shown in Item #123. Where jurisdictions do not adopt Appendix C, no guidance will be provided for determining pipe diameters of the building supply, branches, and risers when implementing the Water Demand Calculator (WDC).

Incorporating Chart C101.1(1) through Chart C101.1(9) from Item #123 into this proposal would prevent this conflict and ensure applicable tools are provided for utilizing the WDC.

The Technical Committee has identified this as the only reason for rejection and requests this change be made via public comment.

TOTAL ELIGIBLE TO VOTE: 30

VOTING RESULTS: AFFIRMATIVE: 25 NEGATIVE: 3 NOT RETURNED: 2 CRAWFORD, WILLIAMS

EXPLANATION OF AFFIRMATIVE:

KENDZEL: As the Chair of the Premise Water Supply System Design Task Group and proponent of the proposal, I support the Committee's suggestions and will bring them to the Task Group for consideration during the public comment period.

EXPLANATION OF NEGATIVE:

KOELLER: As noted on the committee statement, "has identified this as the only reason for rejection" and that reason can be remedied. Therefore, I don't believe this very comprehensive proposal should be rejected due only to a few charts.

LENGER: Although some minor corrections are needed the merit of this proposal is sound and needed.

THOMPSON: Addition of this text to include the Water Demand Calculator is beneficial to users of the code. It should be accepted and brought back during the public comment period with the additional improvements indicated in the committee statement.



CODES ADMINISTRATION

Proposals

Item #: 075

WEStand 2023 Section: Chapter 5

SUBMITTER: Markus Lenger
Chair, WE-Stand Urine Diversion Systems & Treatment Task Group

RECOMMENDATION:
Revise text

CHAPTER 5 COMPOSTING TOILET AND URINE ~~DIVERSION~~ REUSE SYSTEMS

SUBSTANTIATION:

The title of Chapter 5 is being revised as the term "urine diversion" only partially describes the alternative sanitation practice. Moreover, this term suggests that diversion is a means for disposal and does not represent a beneficial use. The proposed term "urine reuse" resolves the limited description and more precisely points to a benefit used over the previous terminology.

COMMITTEE ACTION: ACCEPT AS SUBMITTED

TOTAL ELIGIBLE TO VOTE: 30

VOTING RESULTS: AFFIRMATIVE: 28 NOT RETURNED: 2 CRAWFORD, WILLIAMS



CODES ADMINISTRATION

Proposals

Item #: 076

WEStand 2023 Section: Chapter 5

SUBMITTER: Pat Lando
Recode

RECOMMENDATION:
Revise text

CHAPTER 5

~~ECOLOGICAL-SANITATION COMPOSTING TOILET AND URINE DIVERSION SYSTEMS~~

SUBSTANTIATION:

Information included in Chapter 5 covers alternative sanitation practices which are more commonly referred to as "Ecological-Sanitation" amongst both practitioners and the international community. I am proposing using "Ecological-Sanitation" as the preferred new title.

This proposal was created under my direction as chair of the National Gold Ribbon Commission for Urine Reuse. This commission is a collaborative project to advance the regulation of urine reuse. The commission is comprised of over 100 urine reuse advocates from around the globe, including the leading expert scientists from Stanford, U-Michigan, U. Cal-Davis & Berkely, North Carolina State and Arizona State, EAWAG (Switzerland), Sweden and the Rich Earth Institute in Vermont. I am also the executive director of Recode and Chair of the 2019 IAPMO's WE•Stand Alternative Toileting Task Group. Recode has been a long-time collaborator with IAPMO focusing on water conservation, reuse and sanitation.

COMMITTEE ACTION: REJECT

COMMITTEE STATEMENT:

The proposed new title does not readily indicate what is contained within Chapter 5. The Technical Committee would like to keep reference to composting toilets and urine reuse systems as these are the main topics addressed within the Chapter.

TOTAL ELIGIBLE TO VOTE: 30

VOTING RESULTS: AFFIRMATIVE: 28 NOT RETURNED: 2 CRAWFORD, WILLIAMS



CODES ADMINISTRATION

Proposals

Item #: 077

WEStand 2023 Section: Chapter 5

SUBMITTER: Pat Lando
Recode

RECOMMENDATION:
Revise text

CHAPTER 5 **ECOLOGICAL-SANITATION; COMPOSTING TOILETING AND URINE DIVERSION-REUSE SYSTEMS**

SUBSTANTIATION:

Information included in Chapter 5 covers alternative sanitation practices which are more commonly referred to as "Ecological-Sanitation" amongst both practitioners and the international community. I am proposing using "Ecological-Sanitation" as a new title, while also proposing to revise the existing subtitle. In the event that my preferred new title, "Ecological-Sanitation," is not accepted, I am offering a revised title as an alternative.

The use of "composting toilet" is both grammatically incorrect and inaccurate in its description of these systems. "Composting toilet" translates to either

- 1) a toilet (noun) that is composting (verb), or
- 2) a toilet that performs the composting action at or in the fixture.

The first scenario is clearly wrong and the second scenario only (poorly) describes a small portion of these systems. Using the preferred term of "compost toileting" is more appropriate in both the grammar and the description of these systems. In this case, toileting is a verb and more accurately describes the process while simultaneously using the noun 'compost' as the method of sanitation.

The term urine diversion only partially describes the alternative sanitation practice. Moreover this term suggests that diversion is a means for disposal and does not represent a beneficial use. The proposed term "urine reuse" resolves the limited description and more precisely points to a benefit use over the previous terminology.

This proposal was created under my direction as chair of the National Gold Ribbon Commission for Urine Reuse. This commission is a collaborative project to advance the regulation of urine reuse. The commission is comprised of over 100 urine reuse advocates from around the globe, including the leading expert scientists from Stanford, U-Michigan, U. Cal-Davis & Berkely, North Carolina State and Arizona State, EAWAG (Switzerland), Sweden and the Rich Earth Institute in Vermont. I am also the executive director of Recode and Chair of the 2019 IAPMO's WE•Stand Alternative Toileting Task Group. Recode has been a long-time collaborator with IAPMO focusing on water conservation, reuse and sanitation.

COMMITTEE ACTION: ACCEPT AS AMENDED BY THE TC

CHAPTER 5 **ECOLOGICAL-SANITATION; COMPOSTING TOILETING AND URINE REUSE SYSTEMS**

COMMITTEE STATEMENT:

The proposed title is being modified to reference "composting toilet" as this is consistent with the phrasing used throughout Chapter 5. Additionally, "urine reuse systems" are included within the title as provisions apply to urine

diversion, treatment, and reuse. Reference to only "diversion systems" does not collectively address the contents of the Chapter while "reuse" implies diversion, collection, treatment, and application.

TOTAL ELIGIBLE TO VOTE: 30

VOTING RESULTS: AFFIRMATIVE: 28 NOT RETURNED: 2 CRAWFORD, WILLIAMS



CODES ADMINISTRATION

Proposals

Item #: 078

WEStand 2023 Section: 223.0, 502.1.1, 502.1.2

SUBMITTER: Markus Lenger
Chair, WE-Stand Urine Diversion Systems & Treatment Task Group

RECOMMENDATION:
Revise text

502.0 Design and Construction.

502.1 Requirements. (remaining text unchanged)

502.1.1 ~~Listed~~ Composting Toilets and Composting Toilet Systems. Composting toilets and composting toilet systems shall be listed to NSF 41 or approved by the Authority Having Jurisdiction.

502.1.2 Alternative Design Systems. Where approved by the Authority Having Jurisdiction, composting toilets, urine diverting toilets, urine diverting dry toilets (UDDTs), and urine diversion systems for residential and commercial applications shall comply with the provisions of Section 502.2 through Section 506.1.

223.0 - U -

Urine Diverting Dry Toilet (UDDT). A fixture for collecting, containing, or transporting urine and feces separately without the use of water through independent piping.

Urine Diverting Toilet. A fixture for collecting, containing, or transporting urine and feces separately through independent piping.

SUBSTANTIATION:

Section 502.1.1 is being modified to include "or approved by the Authority Having Jurisdiction" to prevent overly restrictive language. The title of the section has also been updated to remove "listed" and now more appropriately represents the shown requirement.

The proposed additional language to Section 502.1.2 now addresses fixtures found in ecological-sanitation, both compost toileting and urine reuse systems. Terminology has also been provided to support the addition of urine diverting toilets and urine diverting dry toilets. "Toilet" is the root nomenclature for the proposed fixtures and best describes each of the fixture's operation in regard to the source material and water supply. The proposed definitions for these new fixture types used in ecological-sanitation systems are beneficial to users of the WE•Stand and further improve this standard.

COMMITTEE ACTION: ACCEPT AS SUBMITTED

TOTAL ELIGIBLE TO VOTE: 30

VOTING RESULTS: AFFIRMATIVE: 28 NOT RETURNED: 2 CRAWFORD, WILLIAMS



CODES ADMINISTRATION

Proposals

Item #: 079

WEStand 2023 Section: 503.1

SUBMITTER: Pat Lando
Recode

RECOMMENDATION:
Revise text

503.0 Permits.

503.1 General. It shall be unlawful for any person to construct, install, alter, or cause to be constructed, installed, or altered any composting toilet and urine diversion system in a building or on a premise without first obtaining a permit to do such work from the Authority Having Jurisdiction.

Exception: A urine reuse system that is entirely within the limits of a single-family residential property, whereas the beneficial uses are not for resale.

SUBSTANTIATION:

The preferred proposed text creates an exception for permitting non-commercial urine reuse systems where the urine reuse system is for the benefit of a single-family property. Obtaining a permit is a barrier for small-scale systems that pose little risk.

This work was created under my direction as chair of the National Gold Ribbon Commission for Urine Reuse. This commission is a collaborative project to advance the regulation of urine reuse. The commission is comprised of over 100 urine reuse advocates from around the globe, including the leading expert scientists from Stanford, U-Michigan, U. Cal-Davis & Berkely, North Carolina State and Arizona State, EAWAG (Switzerland), Sweden and the Rich Earth Institute in Vermont. I am also the executive director of Recode and Chair of the 2019 IAPMO's WE-Stand; Alternative Toileting Task Group. Recode has been a long-time collaborator with IAPMO focusing on water conservation, reuse and sanitation.

COMMITTEE ACTION: REJECT

COMMITTEE STATEMENT:

The proposed exception would prevent needed regulation of urine reuse systems for single-family residential properties. All urine reuse systems should have permitting requirements to ensure proper disposal methods and to meet minimum health and safety requirements. Additionally, requiring permits for these smaller systems promotes further development and expansion of regulations based on real-world applications.

TOTAL ELIGIBLE TO VOTE: 30

VOTING RESULTS: AFFIRMATIVE: 17 NEGATIVE: 11 NOT RETURNED: 2 CRAWFORD, WILLIAMS

Note: Item # 079 failed to achieve the necessary two-thirds affirmative vote of returned ballots. In accordance with Section 6.8.2 of the Regulations Governing Consensus Development of the Water Efficiency and Sanitation Standard, a public comment is requested for this proposal. The Technical Committee will reconsider this proposal as a public comment.

EXPLANATION OF AFFIRMATIVE:

MANN: The substantiation states that there is "little risk"; that is enough to warrant an inspection.

EXPLANATION OF NEGATIVE:

ALLEN: I agree with John Koeller. This is low risk situation and inline with many other permit exempt situations that are allowed across the country.

BARNES: I agree with many of the negative comments provided. There seems to be minimal risk to health and safety in small-scale applications. Especially when considered to the risks of using other common methods, such as animal manure or conventional fertilizers. The benefits of urine reuse in single-family property applications may outweigh the risks, and requiring permits would only serve to impede those benefits.

CUDAHY: Exempting this from jurisdictional oversight for single-family applications is reasonable. I am not sure it will see wide use.

KENDZEL: Support the comments already provided in support of rejecting the Committee's decision.

KLEIN: I think that this proposal is close but not quite there. Using urine on a residential occupancy happens regularly, but it is difficult to get everyone to pee on the right places at the right times. Diverting urine from a composting toilet makes a great deal of sense as it would seem to be much easier to manage its beneficial use. So, it should be allowed. The use of "whereas" in the second sentence seems very odd.

KOELLER: Do not agree with the committee statement that ALL such systems need regulation. First of all, urine is sterile. Second, why prohibit someone from using urine for fertilizing by setting onerous permitting requirements (which is what would happen!) that would result in 'bootleg' systems subject to local fines or other charges. This proposal was a reasonable accommodation to single-family residential properties and forestalled what would otherwise become more unnecessary government regulation.

LANDO: An established minimum amount of urine for beneficial use should be allowed outright within the WE•Stand. At what point is someone to urinate on their property for beneficial use?! This is the same argument that rainwater reuse had on its inception into the plumbing code.

LANSING: Exempting this from jurisdictional oversight for single-family applications is reasonable, low risk, and will likely promote further adoption.

LENGER: Disagree with committee's findings. No regulation should be applied.

PAPE: I agree with Mr. John Koeller's statements.

THOMPSON: I agree with the comments already submitted. This proposal may help encourage technological improvements in a practice that many rural households already apply on a regular basis. Repurposing urine for fertilization of existing landscape in single-family residential properties versus using potable water to flush seems like the most efficient solution when possible.



CODES ADMINISTRATION

Proposals

Item #: 080

WEStand 2023 Section: 503.1.1

SUBMITTER: Markus Lenger
CleanBlu Innovations Inc.

RECOMMENDATION:
Add new text

503.0 Permits.

503.1 General. (remaining text unchanged)

503.1.1 Urine Diversion Systems. No permit for any urine diversion system shall be issued until the following information is provided to the Authority Having Jurisdiction:

- (1) Name of property owner
- (2) Address
- (3) Date of application
- (4) Parcel number and size, where applicable
- (5) Identification of the public sewer system or documentation for the onsite sewage system serving the property.
- (6) System design information:
 - (a) Location
 - (b) Type
 - (c) Flowrate (gpm)_(L/min)
 - (d) Application rate (in/h)_(mm/h)
 - (e) Design operating pressure (psi)_(kPa)
 - (f) Manufacturer(s) of urine reuse fixtures
 - (g) Location of diversion valve(s)
- (7) Other information required by the Authority Having Jurisdiction

SUBSTANTIATION:

The proposed section is necessary as it lists the information required before a permit should be issued for a urine diversion system. Offering users of the WE•Stand with a clear and appropriate list of required information to submit to AHJ further promotes the use of these systems. For these reasons, the proposed section is necessary.

COMMITTEE ACTION: ACCEPT AS SUBMITTED

TOTAL ELIGIBLE TO VOTE: 30

VOTING RESULTS: AFFIRMATIVE: 28 NOT RETURNED: 2 CRAWFORD, WILLIAMS



CODES ADMINISTRATION

Proposals

Item #: 081

WEStand 2023 Section: 504.2, 504.3

SUBMITTER: Pat Lando
Recode

RECOMMENDATION:
Revise text

504.0 Maintenance and Inspection.

504.2 Composting Toilet; Operation and Maintenance Manual. (remaining text unchanged)

504.3 Urine Diversion; Operation and Maintenance Manual. An owner's manual shall contain instructions for maintenance and shall be transferred to the new owner upon transfer of property or tenancy. The owner's manual shall include:

- (1) Expected input of and capacity for urine storage and urine treatment additives.
- (2) Nutrient management plan (sample plan).
 - (a) Expected schedule for application.
 - (b) Plan for application.
 - (c) Source of additional additives (including onsite materials).
- (3) Schedule and instructions for all regular maintenance tasks.
- (4) Plan for container transfer and cleaning where transfer is used.
- (5) Plan for testing in accordance with the following:
 - (a) Nutrient management plan.
 - (b) Certification of commercial product such as fertilizers and agricultural amendments.

SUBSTANTIATION:

The operation and maintenance (O&M) section was created while I was chair person of the 2019 IAPMO WE•Stand alternative toilet task group. At that time, the task group was focused on compiling all of the information and it largely focused on compost toileting systems. Moreover, our task group did not focus closely enough in this section on differentiating between compost toileting and urine reuse systems.

We understand that these systems are drastically different and deserve their own sections, particularly since application of compost toileting is closer to the US EPA biosolids rules while urine reuse falls under the US DOA agriculture amendment and fertilizer regulations.

The proposed language is an update to the work started with the 2019 task group and it splits the O&M into compost toileting and urine reuse O&M sections. The first change is to identify that the O&M was created for composting toileting. The second change is to create an O&M section specific to urine reuse systems. Unlike the onsite, biosolids or other sanitation rules that align with composting toileting systems, urine reuse systems should be thought of as a component of the department of agriculture regulations.

This proposed language makes reference to the pathogen limits and nutrient application associated with the department of agriculture rules. Most of these rules and requirements are found within a nutrient management plan which is a requirement of this proposed language and possibly the urine treatment.

This work was created under my direction as chair of the National Gold Ribbon Commission for Urine Reuse. This commission is a collaborative project to advance the regulation of urine reuse. The commission is comprised of over 100 urine reuse advocates from around the globe, including the leading expert scientists from Stanford, U-Michigan, U. Cal-Davis & Berkely, North Carolina State and Arizona State, EAWAG (Switzerland), Sweden and the Rich Earth Institute in Vermont. I am also the executive director of Recode and Chair of the 2019 IAPMO's WE•Stand; Alternative Toileting Task Group. Recode has been a long-time collaborator with IAPMO focusing on water conservation, reuse and sanitation.

[Supporting documentation is provided in KAVI for TC review]

COMMITTEE ACTION: ACCEPT AS SUBMITTED

TOTAL ELIGIBLE TO VOTE: 30

VOTING RESULTS: AFFIRMATIVE: 23 NEGATIVE: 4 ABSTAIN: 1 NOT RETURNED: 2 CRAWFORD, WILLIAMS

EXPLANATION OF NEGATIVE:

KENDZEL: Transferring the manual to new owners is not enforceable.

KLEIN: The transfer to new owner requirement is not enforceable and needs to be removed.

SMITH: I agree with Gary Klein.

WHITE: I agree with Jim Kendzel.

EXPLANATION OF ABSTAIN:

BARNES: I agree that requiring transfer of the manual to the new owner is not enforceable.



CODES ADMINISTRATION

Proposals

Item #: 082

WEStand 2023 Section: 505.4, 602.17, 1002.1, 1005.4, 1005.5, 1006.3, A 101.4, A 104.5.4

SUBMITTER: Jazmin Curiel
Self

RECOMMENDATION:
Revise text

505.0 Composting Toilet System Design.

505.4 Commodes. [Commodes shall comply with Section 505.4.1 through Section 505.4.3.](#)

(Section 505.4.1 through Section 505.4.3 are shown for information purposes only)

505.4.1 Odor. Commode design or use shall mitigate the infiltration of odors into the building during normal operation and in the event of temporary power failure.

505.4.2 Contact. Commodes shall transport excreta into the compost processor or contain excreta for transfer as designed according to the owner's manual.

505.4.3 Vectors. Commodes shall limit vectors and prevent human contact except for regular maintenance as designed according to the owner's manual.

602.0 Gray Water Systems.

602.17 Special Provisions. [Special provisions for gray water systems shall comply with Section 602.17.1 and Section 602.17.2.](#)

(Section 602.17.1 and Section 602.17.2 are shown for information purposes only)

602.17.1 Other Collection and Distribution Systems. Other collection and distribution systems shall be approved by the local Authority Having Jurisdiction, as allowed by Section 102.0 of this standard and the plumbing code.

602.17.2 Higher Requirements. Nothing contained in this chapter shall be construed to prevent the Authority Having Jurisdiction from requiring compliance with higher requirements than those contained herein, where such higher requirements are essential to maintain a safe and sanitary condition.

1002.0 Recirculation Systems.

1002.1 Pump Operation. [Pump operation shall be in accordance with Section 1002.1.1 and Section 1002.1.2.](#)

(Section 1002.1.1 and Section 1002.1.2 are shown for information purposes only)

1002.1.1 For Low-Rise Residential Buildings. Circulating hot water systems shall be arranged so that the circulating pump(s) can be turned off (automatically or manually) when the hot water system is not in operation.

1002.1.2 For Pumps Between Boilers and Storage Tanks. When used to maintain storage tank water temperature, recirculating pumps shall be equipped with controls limiting operation to a period from the start of the heating cycle to a maximum of 5 minutes after the end of the heating cycle. [ASHRAE 90.1:7.4.4.4]

1005.0 Mandatory Provisions.

1005.4 Hot Water System Design. [Hot water system design shall comply with Section 1005.4.1 and Section 1005.4.2.](#)

(Section 1005.4.1 and Section 1005.4.2 are shown for information purposes only)

1005.4.1 Recirculation Systems. Recirculation systems shall meet the provisions in Section 1002.0.

1005.4.2 Maximum Volume of Hot Water. The maximum volume of water contained in hot water distribution lines between the water heater and the fixture stop or connection to showers, kitchen faucets, and lavatories shall be determined in accordance with Section 1003.7.

1005.5 Service Water Heating System Controls. [Temperature controls shall comply with Section 1005.5.1 and Section 1005.5.2.](#)

(Section 1005.5.1 and Section 1005.5.2 are shown for information purposes only)

1005.5.1 Storage Temperature Controls. Temperature controls shall be provided that allow for storage temperature adjustment from 120°F (49°C) or lower to a maximum temperature compatible with the intended use.

Exception: When the manufacturers' installation instructions specify a higher minimum thermostat setting to minimize condensation and resulting corrosion. [ASHRAE 90.1:7.4.4.1]

1005.5.2 Outlet Temperature Controls. Temperature controlling means shall be provided to limit the maximum temperature of water delivered from lavatory faucets in public facility restrooms to 110°F (43°C). [ASHRAE 90.1:7.4.4.3]

1006.0 Prescriptive Path.

1006.3 Heat Recovery for Service Water Heating. [Heat recovery systems shall comply with Section 1006.3.1 and Section 1006.3.2.](#)

(Section 1006.3.1 and Section 1006.3.2 are shown for information purposes only)

1006.3.1 Condenser. Condenser heat recovery systems shall be installed for heating or preheating of service hot water provided all of the following are true:

- (1) The facility operates 24 hours a day.
- (2) The total installed heat rejection capacity of the water-cooled systems exceeds 6 000 000 Btu/h (1758 kW) of heat rejection.
- (3) The design service water heating load exceeds 1 000 000 Btu/h (293 kW). [ASHRAE 90.1:6.5.6.2.1]

1006.3.2 Capacity. The required heat recovery system shall have the capacity to provide the smaller of:

- (1) Sixty percent of the peak heat rejection load at design conditions.
- (2) Preheat of the peak service hot water draw to 85°F (29°C). [ASHRAE 90.1:6.5.6.2.2]

Exceptions:

- (a) Facilities that employ condenser heat recovery for space heating with a heat recovery design exceeding 30 percent of the peak water-cooled condenser load at design conditions.
- (b) Facilities that provide 60 percent of their service water heating from site-solar or site-recovered energy or from other sources.

A 101.0 General.

A 101.4 Product and Material Approval. [System components and materials shall be labeled in accordance with Section A 101.4.1 and Section A 101.4.2.](#)

(Section A 101.4.1 and Section A 101.4.2 are shown for information purposes only)

A 101.4.1 Component Identification. System components shall be properly identified as to the manufacturer.

A 101.4.2 Plumbing Materials and Systems. Pipe, pipe fittings, traps, fixtures, material, and devices used in a potable rainwater system shall be listed or labeled (third-party certified) by a listing agency (accredited conformity assessment body) and shall comply with the approved applicable recognized standards referenced in this standard and the plumbing code, and shall be free from defects. Unless otherwise provided for in this standard, all materials, fixtures, or devices used or entering into the construction of plumbing systems, or parts thereof, shall be submitted to the Authority Having Jurisdiction for approval.

A 104.0 Design and Installation.

A 104.5 Rainwater Storage Tanks. (remaining text unchanged)

A 104.5.4 Opening and Access Protection. [Rainwater tank openings shall comply with Section A 104.5.4.1 through Section A 104.5.4.3.](#)

(Section A 104.5.4.1 through Section A 104.5.4.3 are shown for information purposes only)

A 104.5.4.1 Animals and Insects. Rainwater tank openings to the atmosphere shall be protected to prevent the entrance of insects, birds, or rodents into the tank.

A 104.5.4.2 Human Access. Rainwater tank access openings exceeding 12 inches (305 mm) in diameter shall be secured to prevent tampering and unintended entry by either a lockable device or other approved method.

A 104.5.4.3 Exposure to Sunlight. Rainwater tank openings shall not be exposed to direct sunlight.

SUBSTANTIATION:

The above sections are all being modified for the same reason. Sections which are not headings should include provisional language. This aligns with the layout requirements of the Uniform Codes and adds clarity by calling out specific subsections which apply.

COMMITTEE ACTION: ACCEPT AS SUBMITTED

TOTAL ELIGIBLE TO VOTE: 30

VOTING RESULTS: AFFIRMATIVE: 27 ABSTAIN: 1 NOT RETURNED: 2 CRAWFORD, WILLIAMS

EXPLANATION OF ABSTAIN:

LANDO: I reject the use of the term grey water.



CODES ADMINISTRATION

Proposals

Item #: 083

WEStand 2023 Section: Chapter 2, 506.2, 506.14

SUBMITTER: Markus Lenger
Chair, WE-Stand Urine Diversion Systems & Treatment Task Group

RECOMMENDATION:
Revise text

506.0 Urine Diversion System Design.

506.2 Purpose. The purpose of this section is to enable the installation of urine ~~reuse diversion and collection~~ systems ~~to improve the function of composting toilet systems for beneficial use~~ and to prevent nutrient pollution of ground and surface waters.

506.14 Treatment and Application, Reuse, and Disposal. Where stored urine is to be reused onsite, a treatment method for ~~sanitization achieving sanitized urine~~ shall be included in the owner's manual. Approved methods of treatment shall include:

- (1) Retention of stored urine without addition for six months before usage. Two or more holding tanks shall be required for retention,
- (2) ~~Direct a~~Application to the compost processor, or through an approved nutrient management plan (NMP) meeting fecal coliforms not exceeding 2.2 CFU/100 mL, or as determined by the AHJ.
- (3) ~~Pasteurization to 158°F (70°C) for thirty minutes, or Alkaline treatment, or~~
- (4) ~~Other method approved by the Authority Having Jurisdiction. Where urine is heated for at least 15 seconds and not more than 30 minutes, Equation 506.14(1) shall be used to determine the required duration of treatment (D). Where urine is heated for at least 30 minutes at a temperature of not less than 122°F (50°C), Equation 506.14(2) shall be used to determine the required duration of treatment (D).~~

$$D = \frac{131,700,000}{10^{0.14T}} \quad \text{[Equation 506.14(1)]}$$

$$D = \frac{50,070,000}{10^{0.14T}} \quad \text{[Equation 506.14(2)]}$$

Where:

D = duration of treatment, days

T = temperature, °C

203.0 - A -

Agricultural Amendment. A synthetic chemical, natural, or manufactured substance or by-product, or a combination of those substances or by-products, intended to induce crop yields, plant growth or to produce any physical, microbial, or chemical change in the soil.

204.0 - B -

Biosolid. A semisolid, nutrient-rich product of the sewage wastewater treatment process. (Also known as sewage sludge).

208.0 - F -

Fertilizer. A synthetic chemical, natural, or manufactured substance or by-product or a combination of those substances or by-products, intended to induce crop yields, plant growth or to produce any physical, microbial, or chemical change in the soil. Such substances or by-products contain five percent or more of total nitrogen (N), available phosphate (P₂O₅), or soluble potash (K₂O), singly, collectively, or in combination.

220.0 - R -

Raw Urine. Urine which has minimal contact with biofilms, feces, or similarly contaminated materials. Fresh urine is subject to biochemical reactions which are difficult to control. (Also known as fresh urine, urine, yellow water, and pee).

221.0 - S -

Sanitized Urine. Raw urine which has been treated and is therefore classified as a fertilizer and/or an agricultural amendment. Leachate of less than 3 percent solids which has been treated and is therefore classified as a fertilizer and/or an agricultural amendment.

Stored Urine. Raw urine which is collected for beneficial use, is biologically active, and is not a biosolid or part of a private sewage treatment system.

SUBSTANTIATION:

The revisions to Section 506.2 are needed to better describe the updated provisions of this section; “reuse” versus “diversion and collection”. Moreover, the proposed language corrects many false claims that urine reuse is not a part of a compost toileting system. For these reasons, the proposed revisions are necessary.

The title of Section 506.14 is also being modified to remove the phrase “reuse and disposal” to ensure that this document refers to beneficial use or reuse as opposed to a method for disposal of this material. The approved methods of treatment were revised as follows:

Item (1): The term “stored urine” is added to clarify that this is not raw or fresh urine and that when stored, it is collected for beneficial use, is biologically active, and is not a biosolid or part of a private sewage treatment system.

Item (2): The additional language first clarifies that stored urine can be directly applied to a compost processor which then becomes part of a compost toileting system. Second, the stored urine can be directly applied through a nutrient management plan (NMP) which is a best management practice for fertilizer and agricultural soil amendment applications. The values listed within this item are the most common and conservative pathogen limits that a recycled water program allows to be land applied.

Item (3): Treating urine through alkaline addition raises the pH and kills pathogens to meet the approved limitations. Pasteurization has been deleted as it is now addressed in Item (4).

Item (4): This method of treatment relies on proven “time-temperature” calculations for treating biosolids to reduce pathogen risks found within US EPA Part 503 Biosolids Rule, The Four Time-Temperature Regimes for Class A Pathogen Reductions (Alternative 1).

A summary of the US EPA Part 503 Biosolids Rule may be accessed via the link below:

<https://www.epa.gov/sites/default/files/2018-12/documents/plain-english-guide-part503-biosolids-rule.pdf>

The justifications for the listed definitions are as follows:

Providing a definition for “sanitized urine” clarifies that this material has reached a level of treatment for reuse. Under the existing rules and definitions from the U.S. Department of Agriculture (USDA), the reuse of this material is to be classified as an agricultural amendment or fertilizer. These classifications are a critical declaration for placement under the correct regulation.

Typically, agricultural amendments and fertilizers are regulated under the USDA with oversight provided by an environmental regulatory body. Such classifications promote safe urine reuse and align with the terminology used by other regulatory agencies.

In support of the proposed definition for “sanitized urine,” terminology was also generated and provided for “agricultural amendment” and “fertilizer.” Both of these classifications require explanation and further aid users of the WE•Stand when utilizing provisions for urine treatment and reuse.

The definition of “stored urine” is vital because it details the origin of this material prior to treatment and clarifies that this material is not part of a biosolid or private sewage treatment system. Such classification is a critical declaration for stored urine to be placed outside of the US EPA’s biosolid rules since the current WE•Stand

provisions do not incorporate the use of byproducts from wastewater treatment processes.

To provide additional insight, a definition for “biosolid” is being proposed as it further clarifies the origin of the material as a byproduct of the wastewater treatment process. Since there is a lack of current regulations specifically for urine reuse systems, requirements typically fall under the US EPA biosolids rules as they are the only existing regulation for plumbing system wastes. Instead of the approved application falling under the US EPA biosolids rules, it is more appropriate for the Authority Having Jurisdiction to provide approved applications for agricultural amendments and fertilizers. The use of the time-temperature calculations for treating biosolids to reduce pathogen risks found within US EPA Part 503 Biosolids Rule is still however applicable and effective for the treatment of urine.

A definition for “raw urine” is also needed to detail the origin of the untreated material. The proposed language makes it clear that this material has minimal contact with other materials, and it is chemically unstable. It also references varying common names for the material which may cause additional confusion if not listed.

In summary, the definition for “stored urine” is needed to support the recommendation pertaining to Section 506.14, and the terminology provided for “biosolids” and “raw urine” is needed to appropriately interpret and identify “stored urine.”

[Supporting documentation is provided in KAVI for TC review]

COMMITTEE ACTION: ACCEPT AS AMENDED BY THE TC

506.0 Urine Diversion System Design.

506.2 Purpose. The purpose of this section is to enable the installation of urine reuse systems for beneficial use and to prevent nutrient pollution of ground and surface waters.

506.14 Treatment and Application. Where stored urine is to be reused onsite, a treatment method for achieving sanitized urine shall be included in the owner’s manual. Approved methods of treatment shall include:

- (1) Retention of stored urine without addition for six months before usage. Two or more holding tanks shall be required for retention,
- (2) Direct application to the compost processor, or through an approved nutrient management plan (NMP) meeting fecal coliforms not exceeding 2.2 CFU/100 mL, or as determined by the AHJ.
- (3) Alkaline treatment, or
- (4) Where urine is heated for at least 15 seconds and not more than 30 minutes, Equation 506.14(1) shall be used to determine the required duration of treatment (*D*). Where urine is heated for at least 30 minutes at a temperature of not less than 122°F (50°C), Equation 506.14(2) shall be used to determine the required duration of treatment (*D*).

$$D = \frac{131,700,000}{10^{0.14T}} \quad \text{[Equation 506.14(1)]}$$

$$D = \frac{50,070,000}{10^{0.14T}} \quad \text{[Equation 506.14(2)]}$$

Where:

D = duration of treatment, days

T = temperature, °C

203.0 - A -

Agricultural Amendment. A synthetic chemical, natural, or manufactured substance or by-product, or a combination of those substances or by-products, intended to induce crop yields, plant growth or to produce any physical, microbial, or chemical change in the soil.

204.0 - B -

Biosolid. A semisolid, nutrient-rich product of the sewage wastewater treatment process. (Also known as sewage sludge).

208.0 - F -

Fertilizer. A synthetic chemical, natural, or manufactured substance or by-product or a combination of those substances or by-products, intended to induce crop yields, plant growth or to produce any physical, microbial, or chemical change in the soil. Such substances or by-products contain five percent or more of total nitrogen (N), available phosphate (P₂O₅), or soluble potash (K₂O), singly, collectively, or in combination.

220.0 - R -

Raw Urine. Urine which has minimal contact with biofilms, feces, or similarly contaminated materials. Fresh urine is subject to biochemical reactions which are difficult to control. ~~(Also known as fresh urine, urine, yellow water, and pee).~~

221.0 - S -

Sanitized Urine. Raw urine which has been treated and is therefore classified as a fertilizer and/or an agricultural amendment. Leachate of less than 3 percent solids which has been treated and is therefore classified as a fertilizer and/or an agricultural amendment.

Stored Urine. Raw urine which is collected for beneficial use, is biologically active, and is not a biosolid or part of a private sewage treatment system.

COMMITTEE STATEMENT:

The proposed definition for "raw urine" is being modified to remove the listed alternative names, "fresh urine, urine, yellow water, and pee" as is these are not technical terms and do not enhance or clarify the terminology.

TOTAL ELIGIBLE TO VOTE: 30

VOTING RESULTS: AFFIRMATIVE: 28 NOT RETURNED: 2 CRAWFORD, WILLIAMS



CODES ADMINISTRATION

Proposals

Item #: 084

WEStand 2023 Section: 506.3

SUBMITTER: Pat Lando
Recode

RECOMMENDATION:
Revise text

506.0 Urine Diversion System Design.

506.3 Material Requirements. Material used ~~for in~~ urine ~~reuse systems diversion~~ shall be impermeable and ~~corrosion~~ resistant ~~to corrosion from urine~~.

SUBSTANTIATION:

The above revisions are needed to correct grammatical errors and to clarify that materials used for urine reuse systems are to be corrosion resistant. Requiring materials to be only corrosion resistant to urine is incorrect.

COMMITTEE ACTION: ACCEPT AS SUBMITTED

TOTAL ELIGIBLE TO VOTE: 30

VOTING RESULTS: AFFIRMATIVE: 28 NOT RETURNED: 2 CRAWFORD, WILLIAMS



CODES ADMINISTRATION

Proposals

Item #: 085

WEStand 2023 Section: 506.6, 506.8, Appendix D

SUBMITTER: Markus Lenger
CleanBlu Innovations Inc.

RECOMMENDATION:
Revise text

506.0 Urine Diversion System Design.

506.6 Pipe Sizing. Pipe sizes shall be in accordance with the plumbing code. Each urine diversion fixture shall be rated as one drainage fixture unit. Piping or tubing for urine diversion that is less than the minimum pipe diameter required in the plumbing code shall be approved by the Authority Having Jurisdiction.

506.8 Grade of Horizontal Piping. ~~For single or dual commode systems, u~~Urine diversion piping shall be installed at a minimum grade of ½-inch per foot (in/ft) (41.7 mm/m), or 4 percent toward the point of disposal or storage. ~~Where more than two commodes are connected to a urine diversion system, the urine diversion piping shall be installed at a minimum grade of 1/4-inch per foot (in/ft) (20.8 mm/m), or 2 percent toward the point of disposal or storage.~~

SUBSTANTIATION:

The current language is overly restrictive as it requires all horizontal piping for urine diversion systems to be installed at a minimum grade of ½ inch per foot. In cases where there are more than two commodes connected to a urine diversion system, the increased grade is not necessary as there will be heavier flow and more efficient waste disposal. Since pipe sizing is required to be in accordance with plumbing code as specified in Section 506.6, installing the horizontal piping at a lower grade should be allowed.

COMMITTEE ACTION: ACCEPT AS AMENDED BY THE TC

506.0 Urine Diversion System Design.

506.6 Pipe Sizing. Pipe sizes shall be in accordance with the plumbing code. Each urine diversion fixture shall be rated as one drainage fixture unit. Piping or tubing for urine diversion that is less than the minimum pipe diameter required in the plumbing code shall be approved by the Authority Having Jurisdiction.

506.8 ~~Grade-Gradient~~ of Horizontal Piping. ~~For single or dual commode systems, u~~Urine diversion piping shall be installed at a minimum ~~grade-gradient~~ of ½-inch per foot (in/ft) (41.7 mm/m), or 4 percent toward the point of disposal or storage. ~~Where more than two commodes are connected to a urine diversion system, the urine diversion piping shall be installed at a minimum grade of 1/4-inch per foot (in/ft) (20.8 mm/m), or 2 percent toward the point of disposal or storage.~~

**APPENDIX D
COMPOSTING TOILET AND URINE DIVERSION INSPECTION CHECKLIST**

D 201.0 Composting Toilet and Urine Diversion Inspection Checklist. This section includes the inspection checklist form.

Urine Diversion System
<input type="checkbox"/> Material used for urine diversion shall be stainless steel or non-metallic pipe. Concrete piping is prohibited.
<input type="checkbox"/> Urine diversion piping is identifiable and labeled. Pipe diameters are sized in accordance with AHJ and the plumbing code.
<input type="checkbox"/> Where unprocessed urine is transferred from commode to processor(s), provide tools and cleaning materials as described in the owner's manual.
<input type="checkbox"/> Changes in direction of urine diversion piping shall be made by a long-sweep 90-degree fitting or other approved fittings of equivalent sweep.
<input type="checkbox"/> Fixtures discharging into urine diversion piping connected to the plumbing drainage system shall be trapped and vented according to the plumbing code.
<input type="checkbox"/> Urine diversion piping is installed at a minimum grade gradient of 1/2-inch per foot, or 4 percent toward the point of disposal.
<input type="checkbox"/> Urine is diverted to a storage tank or an approved plumbing drainage system.
<input type="checkbox"/> A maintenance plan shall be included per the design system.

(portion of checklist not shown remains unchanged)

COMMITTEE STATEMENT:

The proposal is being modified to provide needed clarity and to remove insufficient piping slopes. The WE•Stand currently uses the term "grade" to describe either a required gradient or the construction level relative to the ground.

There is confusion with the provisions and whether they apply to only gravity drainage systems relying on a gradient (slope) or whether the systems also address a drainage system above a certain height from ground level (grade). In order to clarify this differentiation, Section 506.8 and Section D 201.0 are being revised to use the term "gradient" rather than "grade."

Furthermore, the last sentence of Section 506.8 related to 1/4 inch per foot gradient is being stricken. The 1/4 inch per foot slope is insufficient for urine diversion piping as it does not ensure the required minimum flow velocity of 2 feet per second which is needed to produce a scouring effect in the piping for self-cleaning. Therefore, the section will only retain the existing 1/2 inch per foot slope requirement.

TOTAL ELIGIBLE TO VOTE: 30

VOTING RESULTS: AFFIRMATIVE: 28 NOT RETURNED: 2 CRAWFORD, WILLIAMS



Proposals

Item #: 086

WEStand 2023 Section: 506.7

SUBMITTER: Pat Lando
Recode

RECOMMENDATION:
Revise text

506.0 Urine Diversion System Design.

506.7 Traps. Fixtures discharging into urine diversion piping connected to the plumbing drainage system shall be trapped and vented ~~according to the plumbing code with a backflow seal.~~

SUBSTANTIATION:

Urine reuse systems must take extra precautions to prevent odors, fouling and clogging from occurring. Under normal conditions, raw urine quickly hydrolyzes, forming a precipitate that builds into 'a hard scale' causing pipes to foul. A standard plumbing method to contain odors is the use of a P-trap or liquid sump. Because P-traps and sumps work by using liquid as a means of preventing odors from backflowing, it then becomes a place for urine to collect, hydrolyze and foul the plumbing.

The proposed language allows a greater selection of backflow traps to be used. Waterless urinals have seen great success in silicon mechanical backflow seals. (See Figure 1 and Figure 2 below.) However, under the current plumbing code, a mechanical backflow device or check valve can not be used without a liquid "P-trap" or sump.

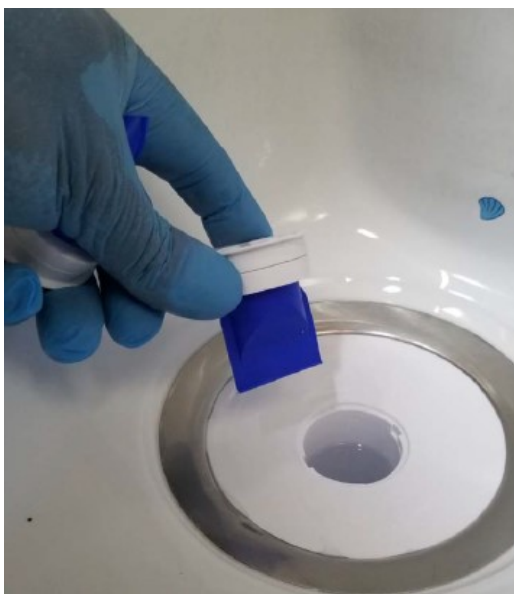

Figure 1 - Silicon Check Valve (New)



Figure 2 - Silicon Check Valve (6 Months)

As documented in 2022 CalTrans Waterless Urinal Study by Dr. Harold Leverenz, UC-Davis, waterless urinals that rely upon a liquid P-trap or sump are far more likely to foul and clog faster than a mechanical check valve that does not rely upon liquid for a backflow seal. (See Figure 3 and Figure 4 below.)



Figure 3 - Sumpless Cartridge Style with Silicon Check Valve (2 Months Operation)



Figure 4 - Sumpless Cartridge Style with Silicon Check Valve (1 Month Operation)

This proposal was created under my direction as chair of the National Gold Ribbon Commission for Urine Reuse. This commission is a collaborative project to advance the regulation of urine reuse. The commission is comprised of over 100 urine reuse advocates from around the globe, including the leading expert scientists from Stanford, U-Michigan, U. Cal-Davis & Berkely, North Carolina State and Arizona State, EAWAG (Switzerland), Sweden and the Rich Earth Institute in Vermont. I am also the executive director of Recode and Chair of the 2019 IAPMO's WE•Stand; Alternative Toileting Task Group. Recode has been a long-time collaborator with IAPMO focusing on water conservation, reuse and sanitation.

[Supporting documentation is provided in KAVI for TC review]

COMMITTEE ACTION: REJECT

COMMITTEE STATEMENT:

The WE•Stand refers the user to the plumbing code for fixture trap requirements. The language in Section 506.7 does not clearly designate that the provided trap requirements are explicit to waterless urinals, and it is unclear as to which fixtures are connected to the plumbing drainage system. Due to these concerns as well as the existing blockage issues associated with urine diversion systems, the proposal is being rejected.

TOTAL ELIGIBLE TO VOTE: 30

VOTING RESULTS: AFFIRMATIVE: 25 NEGATIVE: 3 NOT RETURNED: 2 CRAWFORD, WILLIAMS

EXPLANATION OF AFFIRMATIVE:

ALLEN: I agree with Edward Osann's comment.

KENDZEL: I agree with Edward Osann that the proposal has merit. However, the main issue appears to be related to the device not complying with the existing UPC. Perhaps this can be better addressed by updating the UPC.

KLEIN: Wording needs to be improved during public comment.

OSANN: The proposal has merit. More precise wording should be submitted via public comment to respond to the Committee's objections.

EXPLANATION OF NEGATIVE:

LANDO: The committee's statement is not correct in part because there was a lot of confusion in the room which I believe stemmed from a lack of understanding and joking about "commodos" and the different terms for ecological sanitation toilets. The Committee statement should have only referenced the confusion over if the trap could be installed "according to plumbing code" OR [with] "a backflow seal."

- The discussion over the [struvite] blockage issues was how a backflow seal performed better than a trap seal system. This supports the proposal.

- The lack of specificity referencing "use by a waterless urinal" in the committee's statement was not relevant since this trap could apply to fixtures approved under Chapter 5, such as urinals, waterless urinals or urine diverting dry toilets. Listing the specific fixture here would not be in practice with the WE•Stand format and not complete in practice.

LANSING: I agree with the proponent's statement. Backflow seals are an important component for urine diversion systems.

LENGER: I agree with Pat Lando.



Proposals

Item #: 087

WEStand 2023 Section: 506.12 - 506.12.2

SUBMITTER: Pat Lando
Recode

RECOMMENDATION:
Revise text

506.0 Urine Diversion System Design.

506.12 Urine Storage Tanks. Urine storage tanks shall be constructed and installed in accordance with Section 506.12.1 through Section 506.12.8.

Exception: Urine storage tanks with a volume of less than 55 gallons (gal) (208 L).

506.12.1 Venting. (remaining text unchanged)

506.12.1.1 Vent Size. Pressure equalization vents that prevent ~~nitrogen-nutrient loss by the use of restrictions, or of piping or tubing that is less than the minimum pipe diameter required in the plumbing code~~ shall be at least ½ inch (15 mm) in diameter, or as approved by the Authority Having Jurisdiction.

506.12.2 Traps. When connected to a plumbing system, urine storage tanks shall prevent odors and nitrogen loss from the tank inlet by means of a mechanical backflow seal, P-trap, mechanical trap, submerged inlet piping, or other means approved by the Authority Having Jurisdiction. Submerged inlet piping shall remain submerged during use and after pumpout.

Exceptions:

- (1) Tanks of five gallons or less connected to fixtures with active ventilation or having an integrated seal.
- (2) Urine diverting fixtures that have mechanical backflow prevention traps.

SUBSTANTIATION:

The revision makes an exception for tanks smaller than 55 gallons as a means to promote small urine reuse systems and to remove unnecessary and/or non-relevant requirements. In Section 506.12.1.1, "nutrient loss" is more correct than "nitrogen loss." It is true that urine reuse systems are focused on reusing nitrogen; however urine contains other beneficial substances such as magnesium and potash. Urine reuse systems have used a variety of vent sizes, and practitioners have discovered that ½ inch vents are the preferred size to limit nutrient loss while providing a non-pressurized relief.

The revision to the vent size makes it clear that this requirement is for tanks connected to a plumbing system. It also replaces the requirement for a "P-trap" with a mechanical trap because a P-trap works by holding liquid in the bottom of a 'u-shaped' section of pipe. It becomes a place for urine to collect, hydrolyze, and foul the plumbing. The proposed language allows a greater selection of backflow traps to be used. Urine reuse systems have found that silicon mechanical backflow seals are superior to P-trap devices. The revised language is supported by the 2022 CalTrans Waterless Urinal Study by Dr. Harold Leverenz, UC-Davis.

This proposal was created under my direction as chair of the National Gold Ribbon Commission for Urine Reuse. This commission is a collaborative project to advance the regulation of urine reuse. The commission is comprised of over 100 urine reuse advocates from around the globe, including the leading expert scientists from Stanford, U-Michigan, U. Cal-Davis & Berkely, North Carolina State and Arizona State, EAWAG (Switzerland), Sweden and the Rich Earth Institute in Vermont. I am also the executive director of Recode and Chair of the 2019 IAPMO's WE•Stand; Alternative Toileting Task Group. Recode has been a long-time collaborator with IAPMO focusing on water conservation, reuse and sanitation.

[Supporting documentation is provided in KAVI for TC review]

COMMITTEE ACTION: REJECT

COMMITTEE STATEMENT:

The WE•Stand refers the user to the plumbing code for vent sizing and fixture trap requirements. Furthermore, clarity is needed to distinguish requirements between urine diverting fixture traps and plumbing fixture traps. Additionally, no technical justification was provided for the exception to Section 506.12.

TOTAL ELIGIBLE TO VOTE: 30

VOTING RESULTS: AFFIRMATIVE: 26 NEGATIVE: 2 NOT RETURNED: 2 CRAWFORD, WILLIAMS

EXPLANATION OF AFFIRMATIVE:

ALLEN: I support much of the proposal and look forward to seeing it revised in public comment. I think the committee needs more justification for the 55 gallons size.

OSANN: I agree that the proposed exemption for tanks of 55 gallons or less is not justified. However, the remainder appears to have merit. The proponent should return with a public comment to respond or rebut the points raised by the committee.

EXPLANATION OF NEGATIVE:

LANDO: Urine reuse for beneficial use needs to establish a minimum amount of storage that is safe and practical. The proposal references the support for a 55 gallon minimum storage tank by the +100 member Gold Ribbon Commission for Urine Reuse. This 55-gallon volume was found to be aligned with practices and regulations over a single family residential property.

LANSING: I agree with the proposal, including the exception of 55 gal tanks.



CODES ADMINISTRATION

Proposals

Item #: 088

WEStand 2023 Section: 506.12, 506.12.1

SUBMITTER: Markus Lenger
CleanBlu Innovations Inc.

RECOMMENDATION:
Revise text

506.0 Urine Diversion System Design.

506.12 Urine Storage Tanks. Urine storage tanks greater than 5 gallons (19 L) shall be constructed and installed in accordance with Section 506.12.1 through Section ~~506.12.8~~506.12.9.

506.12.1 Total Storage Volume. The total required storage volume (V) for a urine diversion system shall be determined in accordance with Equation 506.12.1. The use of multiple storage tanks to meet the required total storage volume shall be permitted.

$$V = 0.4 \times N \times t \times \frac{h}{24} \quad (\text{Equation 506.12.1})$$

Where:

h = number of hours where the system is accessible to users, hours per day.

N = number of expected users

t = duration of storage time, days

V = total required volume, gallons (L)

For SI units: 1 gallon = 3.785 L, .

$$V = 1.5 \times N \times t \times \frac{h}{24}$$

(renumber remaining sections)

SUBSTANTIATION:

A method of determining the required storage volume for a urine diversion system is needed to prevent overflow and unsanitary conditions. This formula accounts for the average urine production per person, expected number of users, and required storage time. The equation is explicit to the collection of human urine as the coefficient was derived from the average urine produced per person per day.

Urine collection systems can be connected to a single storage tank or multiple depending on the size of the tank and expected volume of urine over a specified time period. Overall, this equation is simple to use and prevents inadequate sizing of urine storage tanks.

Supporting documentation for the proposed equation may be accessed via the following link:

http://www.susana.org/_resources/documents/default/2-875-giz2011-en-technology-review-urine-diversion.pdf

COMMITTEE ACTION: ACCEPT AS SUBMITTED

506.0 Urine Diversion System Design.

506.12 Urine Storage Tanks. Urine storage tanks greater than 5 gallons (19 L) shall be constructed and installed in accordance with Section 506.12.1 through Section 506.12.9.

506.12.1 Total Storage Volume. The total required storage volume (V) for a urine diversion system shall be determined in accordance with Equation 506.12.1. The use of multiple storage tanks to meet the required total storage volume shall be permitted.

$$V = 0.4 \underline{A} \times N \times t \times \frac{h}{24} \quad (\text{Equation 506.12.1})$$

Where:

$$\underline{A} = 0.4$$

h = number of hours where the system is accessible to users, hours per day

N = number of expected users

t = duration of storage time, days

V = total required volume, gallons (~~L~~)

For SI units: 1 gallon = 3.785 L, $\underline{A} = 1.5$

$$\underline{V} = 1.5 \times N \times t \times \frac{h}{24}$$

(renumber remaining sections)

COMMITTEE STATEMENT:

An editorial revision was made to clarify the use IP versus SI units when solving Equation 506.12.1. The addition of coefficient "A" and the removal of "(L)" offers such clarity for the end user and prevents incorrect use of units.

TOTAL ELIGIBLE TO VOTE: 30

VOTING RESULTS: AFFIRMATIVE: 28 NOT RETURNED: 2 CRAWFORD, WILLIAMS



CODES ADMINISTRATION

Proposals

Item #: 089

WEStand 2023 Section: 506.12.3.2, 506.12.5, 506.12.6

SUBMITTER: Markus Lenger
CleanBlu Innovations Inc.

RECOMMENDATION:
Revise text

506.0 Urine Diversion System Design.

506.12 Urine Storage Tanks. (remaining text unchanged)

506.12.3 Overflow. (remaining text unchanged)

506.12.3.2 Alarms. Storage tanks shall be equipped with a visible and audible alarm to indicate when the tank has reached 80 percent capacity.

Exception: Urine storage tanks utilized for sterilization or other approved treatment methods in accordance with Section 506.14.

506.12.5 Above Grade. Above grade storage tanks shall be prohibited where subject to freezing conditions, or shall be provided with an adequate means of freeze protection. ~~The above grade urine storage tank shall be provided with an audible and visual high-water alarm.~~

506.12.6 Below Grade. Urine storage tanks installed below grade shall be structurally designed to withstand all anticipated earth or other loads. Tank covers shall be capable of supporting an earth load of not less than 300 pounds per square foot (lb/ft²) (1465 kg/m²) when the tank is designed for underground installation. Below grade urine tanks installed underground shall be provided with manholes. The manhole opening shall be a minimum diameter of 20 inches (508 mm) and located a minimum of 4 inches (102 mm) above the surrounding grade. The surrounding grade shall be sloped away from the manhole. Underground tanks shall be ballasted, anchored, or otherwise secured, to prevent the tank from floating out of the ground when empty. The combined weight of the tank and hold down system ~~should shall~~ meet or exceed the buoyancy force of the tank. ~~The below grade urine storage tank level shall be provided with an audible and visual high-water alarm.~~

SUBSTANTIATION:

The requirement for alarms applies to both above and below grade storage tanks and is therefore better suited in the proposed new location. In addition, there is currently no listed capacity limit to set off the alarm. Providing a limit of 80% gives ample time to prevent overflow. Furthermore, the exception has been provided to address tanks which are sealed for sterilization as this type of treatment requires storage without addition.

COMMITTEE ACTION: ACCEPT AS SUBMITTED

TOTAL ELIGIBLE TO VOTE: 30

VOTING RESULTS: AFFIRMATIVE: 28 NOT RETURNED: 2 CRAWFORD, WILLIAMS

EXPLANATION OF AFFIRMATIVE:

LANDO: Item #90 added a key component to add into this proposal:

Section 506.12.5 - Above grade storage tanks shall be "structurally designed to withstand all anticipated" freezing conditions, or shall be provided with an adequate means of freeze protection.



CODES ADMINISTRATION

Proposals

Item #: 090

WEStand 2023 Section: 506.12.5

SUBMITTER: Pat Lando
Recode

RECOMMENDATION:
Revise text

506.0 Urine Diversion System Design.

506.12 Urine Storage Tanks. (remaining text unchanged)

506.12.5 Above Grade. Above grade storage tanks shall be ~~prohibited where subject to structurally designed to withstand all anticipated~~ freezing conditions, or shall be provided with an adequate means of freeze protection. The above grade urine storage tank shall be provided with an audible and visual high-~~level~~water alarm.

SUBSTANTIATION:

Section 506.12.5 is being revised as an available treatment method for urine reuse includes freezing the stored urine. This proposed language allows storage tanks to freeze with the requirement that they are structurally design to withstand the freezing action exerted on the tank. Additionally, the revision removes "water" from the text as the liquid in the tank is urine.

This proposal was created under my direction as chair of the National Gold Ribbon Commission for Urine Reuse. This commission is a collaborative project to advance the regulation of urine reuse. The commission is comprised of over 100 urine reuse advocates from around the globe, including the leading expert scientists from Stanford, U-Michigan, U. Cal-Davis & Berkely, North Carolina State and Arizona State, EAWAG (Switzerland), Sweden and the Rich Earth Institute in Vermont. I am also the executive director of Recode and Chair of the 2019 IAPMO's WE•Stand Alternative Toileting Task Group. Recode has been a long-time collaborator with IAPMO focusing on water conservation, reuse and sanitation.

COMMITTEE ACTION: REJECT

COMMITTEE STATEMENT:

Item #090 is being rejected based on the action taken on Item #089 as it requires all urine storage tanks, which are not utilized for sterilization and treatment, to be equipped with a visible and audible alarm set to 80 percent capacity.

TOTAL ELIGIBLE TO VOTE: 30

VOTING RESULTS: AFFIRMATIVE: 28 NOT RETURNED: 2 CRAWFORD, WILLIAMS



CODES ADMINISTRATION

Proposals

Item #: 091

WEStand 2023 Section: 506.12.8

SUBMITTER: Markus Lenger
CleanBlu Innovations Inc.

RECOMMENDATION:
Revise text

506.0 Urine Diversion System Design.

506.12 Urine Storage Tanks. (remaining text unchanged)

506.12.8 Openings. All openings shall be covered and secured to prevent tampering. Openings shall be screened or covered to prevent rodent infiltration and be protected against unauthorized human entry.

Exception: Where tanks have a volume not exceeding 5 gallons (19 L) and comply with one of the following:

- (1) Are connected to a fixture(s) with active ventilation, or
- (2) Have an integrated seal.

SUBSTANTIATION:

The exception has been added to address tanks with minimal volumes which do not require protection against human entry or rodent infiltration when connected to fixtures with active ventilation or when installed with an integrated seal. Requiring such protection on smaller tanks which meet these exceptions is both unnecessary and overly restrictive.

COMMITTEE ACTION: ACCEPT AS SUBMITTED

TOTAL ELIGIBLE TO VOTE: 30

VOTING RESULTS: AFFIRMATIVE: 28 NOT RETURNED: 2 CRAWFORD, WILLIAMS



CODES ADMINISTRATION

Proposals

Item #: 092

WEStand 2023 Section: 506.13.1

SUBMITTER: Markus Lenger
CleanBlu Innovations Inc.

RECOMMENDATION:
Add new text

506.0 Urine Diversion System Design.

506.13 Maintenance Plan. (remaining text unchanged)

506.13.1 Pipe Cleaning. Urine diversion piping shall be cleaned using one of the following:

- (1) Acetic acid,
- (2) Citric acid,
- (3) Sodium hydroxide,
- (4) Suitable biodegradable surfactant, or
- (5) Other cleaning agents approved by the Authority Having Jurisdiction.

SUBSTANTIATION:

The use of appropriate cleaning agents is necessary to ensure that precipitates collected within the urine diversion piping are removed. In systems where urine is diluted, the formation of dissolved salts can potentially cause blockages in the piping system if not cleaned properly.

Acetic acid and citric acid are organic compounds that are powerful enough to dissolve mineral deposits and kill bacteria. Sodium hydroxide is a commonly used alkaline cleaning agent which can dissolve protein based deposits and has decent disinfection properties. In order to prevent overly restrictive cleaning agent requirements, option (5) has been included.

COMMITTEE ACTION: REJECT

COMMITTEE STATEMENT:

The proposal is being rejected as the language is unenforceable and only permits the use of one of the listed cleaning agents. In order to avoid this limitation, the phrasing "one or more of the following" would be better suited. Furthermore, the language should specify that such information is to be included within the pipe cleaning schedule.

TOTAL ELIGIBLE TO VOTE: 30

VOTING RESULTS: AFFIRMATIVE: 27 ABSTAIN: 1 NOT RETURNED: 2 CRAWFORD, WILLIAMS

EXPLANATION OF AFFIRMATIVE:

ALLEN: I agree with John Koeller, a few edits will fix this one.

KOELLER: A bit of minor editing will fix this one.

EXPLANATION OF ABSTAIN:

LANDO: The proposal should be revised "one or more of the following" cleaning products.



CODES ADMINISTRATION

Proposals

Item #: 093

WEStand 2023 Section: Table 601.5.1

SUBMITTER: Laura Allen
Greywater Action

RECOMMENDATION:
Revise text

**TABLE 601.5.1
MINIMUM ALTERNATE WATER SOURCE TESTING, INSPECTION, AND MAINTENANCE FREQUENCY**

DESCRIPTION	MINIMUM FREQUENCY
Inspect and clean filters and screens, and replace (if necessary)	<u>In accordance with the manufacturer's instructions or</u> Every 3 months
Inspect and maintain mulch basins for gray water irrigation systems	<u>Once per year, or as</u> needed to maintain mulch depth and prevent ponding and runoff

(portion of table not shown remains unchanged)

SUBSTANTIATION:

Filter cleaning varies based on the type of filter and usage. So the frequency should be done in accordance with the manufacturer's instructions. Additionally, mulch basins should be checked at least once a year.

COMMITTEE ACTION: ACCEPT AS SUBMITTED

TOTAL ELIGIBLE TO VOTE: 30

VOTING RESULTS: AFFIRMATIVE: 24 NEGATIVE: 3 ABSTAIN: 1 NOT RETURNED: 2 CRAWFORD, WILLIAMS

EXPLANATION OF AFFIRMATIVE:

ALLEN: John Koeller and Thomas Pape's comments are relevant to the entire table, which is unenforceable, not the proposed changes to the table. Since the table is currently in WE•Stand, I think we should accept this proposal and make the table better. If people want to propose to remove the entire table in the future because it's unenforceable, then we could have that conversation at that time.

EXPLANATION OF NEGATIVE:

KOELLER: Agree with Mr. Thomas Pape's comment.

PAPE: This is unenforceable. The inspector cannot make regular visits to the premise to assure maintenance performance.

PREMER: I think this is well intended, but there are currently no state or local agencies that can enforce this.

EXPLANATION OF ABSTAIN:

SOVOCOOL: I'm not certain I have the background or certainty level to support this, but if the committee feels comfortable going this direction I won't stand in the way.



CODES ADMINISTRATION

Proposals

Item #: 094

WEStand 2023 Section: 601.7, Table 1201.1

SUBMITTER: Robert Pickering
Eastern Research Group, Inc. (ERG)
Environmental Protection Agency (EPA)

RECOMMENDATION:
Revise text

601.0 General.

601.7 Minimum Water Quality Requirements. The minimum water quality for alternate water source systems shall meet the applicable water quality requirements for the intended application as determined by the Authority Having Jurisdiction. In the absence of water quality requirements for on-site treated nonpotable systems, the water quality requirements of NSF 350 or the ~~EPA/625/R-04/108~~ [EPA/600/R-12/618](#) shall apply.

Exception: Water treatment is not required for gray water used for subsurface irrigation.

**TABLE 1201.1
REFERENCED STANDARDS**

STANDARD NUMBER-YEAR	STANDARD TITLE	REFERENCED SECTION
EPA/625/R-04/108-2004 EPA/600/R-12/618-2012	Guidelines for Water Reuse	601.7

(portion of table not shown remains unchanged)

Note: [EPA/600/R-12/618-2012](#) does not meet the requirements for a mandatory referenced standard in accordance with Section 15.0 of IAPMO's Regulations Governing Consensus Development of the Water Efficiency and Sanitation Standard.

SUBSTANTIATION:

The above revisions to Section 601.7 and Table 1201.1 incorporate the latest edition of EPA's Guidelines for Water Reuse.

COMMITTEE ACTION: ACCEPT AS AMENDED BY THE TC

601.0 General.

601.7 Minimum Water Quality Requirements. The minimum water quality for alternate water source systems shall meet the applicable water quality requirements for the intended application as determined by the Authority Having Jurisdiction. In the absence of water quality requirements for on-site treated nonpotable systems, the water quality requirements of [IAPMO IGC 324](#), NSF 350, or the [EPA/600/R-12/618](#) shall apply.

Exception: Water treatment is not required for gray water used for subsurface irrigation.

**TABLE 1201.1
REFERENCED STANDARDS**

STANDARD NUMBER-YEAR	STANDARD TITLE	REFERENCED SECTION
EPA/600/R-12/618-2012	Guidelines for Water Reuse	601.7

(portion of table not shown remains unchanged)

COMMITTEE STATEMENT:

The proposal is being modified to include reference to IAPMO IGC 324, NSF 350, and EPA/600/R-12/618. The Technical Committee prefers that all three standards be available for the Authority Having Jurisdiction to use in the absence of water quality requirements for on-site treated nonpotable systems.

TOTAL ELIGIBLE TO VOTE: 30

VOTING RESULTS: AFFIRMATIVE: 28 NOT RETURNED: 2 CRAWFORD, WILLIAMS



CODES ADMINISTRATION

Proposals

Item #: 095

WESand 2023 Section: 601.7, Table 1201.1

SUBMITTER: Jazmin Curiel
Self

RECOMMENDATION:
Revise text

601.0 General.

601.7 Minimum Water Quality Requirements. The minimum water quality for alternate water source systems shall meet the applicable water quality requirements for the intended application as determined by the Authority Having Jurisdiction. In the absence of water quality requirements for on-site treated nonpotable systems, the water quality requirements of ~~IAPMO IGC 324 or NSF/ANSI 350 or the EPA/625/R-04/108~~ shall apply.

Exception: Water treatment is not required for gray water used for subsurface irrigation.

TABLE 1201.1
REFERENCED STANDARDS

STANDARD NUMBER-YEAR	STANDARD TITLE	REFERENCED SECTION
EPA/625/R-04/108-2004	Guidelines for Water Reuse	601.7

(portion of table not shown remains unchanged)

Note: IAPMO IGC 324 and NSF/ANSI 350 meet the requirements for mandatory referenced standards in accordance with Section 15.0 of IAPMO's Regulations Governing Consensus Development of the Water Efficiency and Sanitation Standard.

SUBSTANTIATION:

The modification removes reference to EPA/625/R-04/108 as it is not written in mandatory language. The 2019 edition of the IAPMO IGC 324 has been greatly improved. There was input from the San Francisco Department of Public Health (SFDPH) in developing this latest edition.

In addition to the below substantiation, please see support letter from LADWP for the Technical Committee review.

IAPMO IGC 324 covers residential, multi-family, and commercial use applications intended to process water from alternate water sources such as greywater, rainwater, stormwater air conditioning condensate, cooling tower makeup, vehicle wash and other non-potable reuse applications not specifically listed, for use in subsurface and/or surface irrigation and toilet/urinal flushing applications, and specifies requirements for materials, physical characteristics, performance testing, and markings. The standard also covers test plans and safety check (failure modes effects) that ensures the safety of the treated water.

[Supporting documentation is provided in KAVI for TC review]

COMMITTEE ACTION: REJECT

COMMITTEE STATEMENT:

Item #095 is being rejected based on the action taken on Item #094. The Technical Committee wishes to reference IAPMO IGC 324, NSF 350, and EPA/600/R-12/618. All three applicable standards should be available to the Authority Having Jurisdiction for use in the absence of water quality requirements for on-site treated nonpotable systems.

TOTAL ELIGIBLE TO VOTE: 30

VOTING RESULTS: AFFIRMATIVE: 28 NOT RETURNED: 2 CRAWFORD, WILLIAMS



CODES ADMINISTRATION

Proposals

Item #: 096

WEStand 2023 Section: 601.10.1

SUBMITTER: Laura Allen
Greywater Action

RECOMMENDATION:
Revise text

601.0 General.

601.10 Commercial, Industrial, and Institutional Restroom Signs. (remaining text unchanged)

601.10.1 Equipment Room Signs. Each room containing reclaimed (recycled) water and on-site treated water, equipment shall have a sign posted in a location that is visible to anyone working on or near nonpotable water equipment with the following wording in **at least** 1 inch (25.4 mm) **in height** letters:

CAUTION: NONPOTABLE * _____ *, DO NOT DRINK. DO NOT CONNECT TO DRINKING WATER SYSTEM.

NOTICE: CONTACT BUILDING MANAGEMENT BEFORE PERFORMING ANY WORK ON THIS WATER SYSTEM.

* _____ * Shall indicate RECLAIMED (RECYCLED) WATER or ON-SITE TREATED WATER accordingly.

SUBSTANTIATION:

Depending on how far away the sign is from the viewer, larger than 1 inch letters may be more visible. The WE•Stand should allow larger, but not smaller, letter size.

COMMITTEE ACTION: ACCEPT AS SUBMITTED

601.0 General.

601.10 Commercial, Industrial, and Institutional Restroom Signs. (remaining text unchanged)

601.10.1 Equipment Room Signs. Each room containing reclaimed (recycled) water and on-site treated water, equipment shall have a sign posted in a location that is visible to anyone working on or near nonpotable water equipment with the following wording in **at least not less than** 1 inch (25.4 mm) in height letters:

CAUTION: NONPOTABLE * _____ *, DO NOT DRINK. DO NOT CONNECT TO DRINKING WATER SYSTEM.

NOTICE: CONTACT BUILDING MANAGEMENT BEFORE PERFORMING ANY WORK ON THIS WATER SYSTEM.

* _____ * Shall indicate RECLAIMED (RECYCLED) WATER or ON-SITE TREATED WATER accordingly.

COMMITTEE STATEMENT:

The Technical Committee wishes to make an editorial revision to Item #096 for consistency with the phrasing, "not less than," as used within Item #112 when referring to minimum values.

TOTAL ELIGIBLE TO VOTE: 30

VOTING RESULTS: AFFIRMATIVE: 28 NOT RETURNED: 2 CRAWFORD, WILLIAMS



CODES ADMINISTRATION

Proposals

Item #: 097

WEStand 2023 Section: 601.11.2.1, 601.11.2.2, 603.5, 604.5, 902.5, 903.14.2.1, 903.14.2.2

SUBMITTER: Billy Smith
Chair, WE-Stand Technical Committee

RECOMMENDATION:
Revise text

601.0 General.

601.11 Inspection and Testing. (remaining text unchanged)

601.11.2 Annual Cross-Connection Inspection and Testing. (remaining text unchanged)

601.11.2.1 Visual System Inspection. Prior to commencing the cross-connection testing, a dual system inspection shall be conducted by the Authority Having Jurisdiction and other authorities having jurisdiction as follows:

(1) - (3) (remaining text unchanged)

601.11.2.2 Cross-Connection Test. The procedure for determining cross-connection shall be followed by the applicant in the presence of the Authority Having Jurisdiction and other authorities having jurisdiction to determine whether a cross-connection has occurred as follows:

(1) - (9) (remaining text unchanged)

603.0 Reclaimed (Recycled) Water Systems.

603.5 Initial Cross-Connection Test. A cross-connection test is required in accordance with Section 601.11.2. Before the building is occupied or the system is activated, the installer shall perform the initial cross-connection test in the presence of the Authority Having Jurisdiction and other authorities having jurisdiction. The test shall be ruled successful by the Authority Having Jurisdiction before final approval is granted.

604.0 On-Site Treated Nonpotable Water Systems.

604.5 Initial Cross-Connection Test. A cross-connection test is required in accordance with Section 601.11.2. Before the building is occupied or the system is activated, the installer shall perform the initial cross-connection test in the presence of the Authority Having Jurisdiction and other authorities having jurisdiction. The test shall be ruled successful by the Authority Having Jurisdiction before final approval is granted.

902.0 Nonpotable Rainwater Catchment Systems.

902.5 Initial Cross-Connection Test. Where any portion of a rainwater catchment system is installed within a building, a cross-connection test is required in accordance with 903.14.2. Before the building is occupied or the system is activated, the installer shall perform the initial cross-connection test in the presence of the Authority Having Jurisdiction. The test shall be ruled successful by the Authority Having Jurisdiction and other authorities having jurisdiction before final approval is granted.

903.0 Design and Installation.

903.14 Inspection and Testing. (remaining text unchanged)

903.14.2 Annual Cross-Connection Inspection and Testing. (remaining text unchanged)

903.14.2.1 Visual System Inspection. Prior to commencing the cross-connection testing, a dual system inspection shall be conducted by the Authority Having Jurisdiction and other authorities having jurisdiction as follows:

(1) - (3) (remaining text unchanged)

903.14.2.2 Cross-Connection Test. The procedure for determining cross-connection shall be followed by the applicant in the presence of the Authority Having Jurisdiction and other authorities having jurisdiction to determine whether a cross-connection has occurred as follows:

(1) - (9) (remaining text unchanged)

SUBSTANTIATION:

The proposed modifications are being made to ensure that inspections and cross connection tests are conducted by the appropriate professionals. The Authority Having Jurisdiction may specify who is permitted to conduct such inspection and testing; however the distinction must be made to include the phrasing "and other authorities having jurisdiction" in order to guarantee all appropriate authorities are present at the time of testing. This language is also consistent with the plumbing code.

COMMITTEE ACTION: REJECT

COMMITTEE STATEMENT:

The proposal is being rejected as the phrasing "and other authorities having jurisdiction" is both unnecessary and repetitive. The definition for "Authority Having Jurisdiction," as provided in the WE-Stand, includes federal, state, local, or regional departments; individuals such as a plumbing official, mechanical official, labor department official, health department official, building official; or others having statutory authority.

TOTAL ELIGIBLE TO VOTE: 30

VOTING RESULTS: AFFIRMATIVE: 28 NOT RETURNED: 2 CRAWFORD, WILLIAMS



CODES ADMINISTRATION

Proposals

Item #: 098

WEStand 2023 Section: 601.12

SUBMITTER: Billy Smith
Chair, WE-Stand Technical Committee

RECOMMENDATION:
Revise text

601.0 General.

601.12 Separation Requirements. All underground alternate water source service piping other than gray water shall be separated from the building sewer in accordance with the plumbing code. ~~Treated nonpotable water p~~Pipes carrying treated nonpotable water shall be permitted to be run or laid in the same trench as potable water pipes ~~shall have~~with a 12 inch (305 mm) minimum vertical and horizontal separation ~~when~~where both pipe materials are approved for use within a building. Where horizontal piping materials do not ~~meet~~comply with this requirement, the minimum separation shall be increased to 60 inches (1524 mm). The potable water piping shall be installed at an elevation above the treated nonpotable water piping.

SUBSTANTIATION:
Section 601.12 is being modified to clarify that the pipes carry and distribute treated non-potable water. This change is needed to remove ambiguous language and add clarity to the intent of the section. Lastly, similar language was accepted by the UPC Technical Committee for Item #258.

COMMITTEE ACTION: ACCEPT AS SUBMITTED

TOTAL ELIGIBLE TO VOTE: 30

VOTING RESULTS: AFFIRMATIVE: 28 NOT RETURNED: 2 CRAWFORD, WILLIAMS



CODES ADMINISTRATION

Proposals

Item #: 099

WEStand 2023 Section: 602.6.1

SUBMITTER: Laura Allen
Greywater Action

RECOMMENDATION:
Add new text

602.0 Gray Water Systems.

602.6 Backwater Valves. (remaining text unchanged)

602.6.1 Cleanout Labeling. Cleanouts for drains that pass through a backwater valve shall be clearly identified with a permanent label stating: "BACKWATER VALVE DOWNSTREAM"

SUBSTANTIATION:

Cleanouts for drains that pass through a backwater valve are already required to be labeled this way in the UPC. I think including the requirement here is important to call people's attention to this since we're requiring them to install backwater valves for gray water systems.

COMMITTEE ACTION: ACCEPT AS SUBMITTED

TOTAL ELIGIBLE TO VOTE: 30

VOTING RESULTS: AFFIRMATIVE: 28 NOT RETURNED: 2 CRAWFORD, WILLIAMS



CODES ADMINISTRATION

Proposals

Item #: 100

WEStand 2023 Section: Table 602.8

SUBMITTER: Laura Allen
Greywater Action

RECOMMENDATION:
Revise text

**TABLE 602.8
LOCATION OF GRAY WATER SYSTEM**

MINIMUM HORIZONTAL DISTANCE IN CLEAR REQUIRED FROM:	SURGE TANK (feet)	SUBSURFACE AND SUBSOIL IRRIGATION FIELD AND MULCH BED (feet)
Building structures ¹	0 ^{2,9}	2 ^{3,82,7}
Property line adjoining private property	5	5 ⁸⁷
Water supply wells ⁴³	50	100
Streams and lakes ⁴³	50	50 ⁵⁴
Sewage pits or cesspools	5	5
Sewage disposal field	5	4 ⁶⁵
Septic tank	0	5
On-site domestic water service line	5	5
Pressurized public water main	10	10 ⁷⁶

For SI units: 1 foot = 304.8 mm

Notes: ~~Where irrigation or disposal fields are installed in sloping ground, the minimum horizontal distance between any part of the distribution system and the ground surface shall be 15 feet (4572 mm).~~

¹ ~~Building structures do not include~~ Including porches and steps, whether covered or uncovered, breezeways, roofed carports, roofed patios, carports, covered walks, covered driveways, and similar structures or appurtenances.

~~² The distance shall be permitted to be reduced to 0 feet for aboveground tanks when first approved by the Authority Having Jurisdiction.~~

³² Reference to a 45 degree (0.79 rad) angle from foundation.

⁴³ Where special hazards are involved, the distance required shall be increased as directed by the Authority Having Jurisdiction.

⁵⁴ These minimum clear horizontal distances shall also apply between the irrigation or disposal field and the ocean mean higher high tide line.

⁶⁵ Add 2 feet (610 mm) for each additional foot of depth in excess of 1 foot (305 mm) below the bottom of the drain line.

⁷⁶ For parallel construction or for crossings, approval by the Authority Having Jurisdiction shall be required.

⁸⁷ The distance shall be permitted to be reduced to 1 1/2 feet (457 mm) for drip and mulch basin irrigation systems.

~~⁹ The distance shall be permitted to be reduced to 0 feet for surge tanks of 75 gallons (284 L) or less.~~

SUBSTANTIATION:

The minimum required horizontal distance from building structures is not consistent with the rest of the plumbing code. Sewage ejection pumps, which contain sewage, are allowed to be inside buildings and have no setbacks. Gray water tanks should be treated the same. If the plumbing is diverted in the basement or mechanical room, the surge tank would be located inside, not outside 5 feet away from the building.

Note (1) is being revised since Table 602.8 is consistent with the CPC, and the CPC says that these are not considered a building structure. It doesn't make sense to have these setbacks for covered walks, breezeways, steps, etc., that are not part of the building structure.

If the new distance of 0 feet is approved, Note (2) and Note (9) will not be used or referenced in the table and should therefore be removed.

COMMITTEE ACTION: ACCEPT AS SUBMITTED

TOTAL ELIGIBLE TO VOTE: 30

VOTING RESULTS: AFFIRMATIVE: 28 NOT RETURNED: 2 CRAWFORD, WILLIAMS



CODES ADMINISTRATION

Proposals

Item #: 101

WEStand 2023 Section: 602.13.1

SUBMITTER: Laura Allen
Greywater Action

RECOMMENDATION:
Revise text

602.0 Gray Water Systems.

602.13 Gray Water System Components. (remaining text unchanged)

602.13.1 Surge Tanks. Where installed, surge tanks shall comply with the following:

(1) – (7) (remaining text unchanged)

(8) ~~If a surge tank is installed underground, the system shall be designed so that the tank overflow will gravity drain to the existing sewer line or septic tank.~~ The tank shall be protected against sewer line backflow by a backwater valve installed in accordance with the plumbing code.

(9) – (10) (remaining text unchanged)

SUBSTANTIATION:

The requirements for a surge tank should be consistent with requirements for a sewage sump tank (sewage ejection tank). Sump tanks containing sewage are not required to have a gravity overflow to the sewer. So a tank merely containing gray water should also not be required to have this.

COMMITTEE ACTION: ACCEPT AS SUBMITTED

TOTAL ELIGIBLE TO VOTE: 30

VOTING RESULTS: AFFIRMATIVE: 28 NOT RETURNED: 2 CRAWFORD, WILLIAMS



CODES ADMINISTRATION

Proposals

Item #: 102

WEStand 2023 Section: 602.13.2

SUBMITTER: Billy Smith
Chair, WE-Stand Technical Committee

RECOMMENDATION:
Revise text

602.0 Gray Water Systems.

602.13 Gray Water System Components. (remaining text unchanged)

602.13.2 Gray Water Pipe and Fitting Materials. Aboveground and underground building drainage and vent pipe and fittings for gray water systems shall comply with the requirements for aboveground and underground sanitary building drainage and vent pipe and fittings in the plumbing code. These materials shall extend not less than 2 feet (610 mm) outside the building.

SUBSTANTIATION:

Aboveground and underground building drainage and vent pipe and fittings for gray water systems must extend outside of the building to allow for termination into an approved gray water diverter valve before connecting to the waste system from non-gray water fixtures. For this reason, the minimum extension is necessary. This language is also consistent with the plumbing code.

COMMITTEE ACTION: REJECT

COMMITTEE STATEMENT:

The proposal is being rejected as the requirement for gray water piping and materials to extend outside of the building is not applicable to all gray water systems. There exists gray water systems which collect gray water and do not drain outside of the building. Therefore, this requirement would be impractical and overly stringent.

TOTAL ELIGIBLE TO VOTE: 30

VOTING RESULTS: AFFIRMATIVE: 28 NOT RETURNED: 2 CRAWFORD, WILLIAMS



CODES ADMINISTRATION

Proposals

Item #: 103

WEStand 2023 Section: 602.15.1.3

SUBMITTER: Billy Smith
Chair, WE-Stand Technical Committee

RECOMMENDATION:
Revise text

602.0 Gray Water Systems.

602.15 Subsurface and Subsoil Irrigation Field, and Mulch Basin Design and Construction. (remaining text unchanged)

602.15.1 Subsurface Irrigation Field. (remaining text unchanged)

602.15.1.3 Emitter Size. Emitters shall be installed in accordance with the manufacturer's installation instructions. Emitters shall have a flow path of not less than 1200 microns (μ) (1200 μ m) and shall have a manufacturing coefficient of variation (C_v) not exceeding 7 percent. Irrigation systems shall be designed to have an emitter flow variation not exceeding 10 percent.

SUBSTANTIATION:

In subsurface irrigation fields, emitters are used to convey gray water via microirrigation. The deviation of mean flow rate from nominal flow rate is used to determine this coefficient of variation (C_v). The provided variation limit of 7 percent is consistent with performance requirements listed in industry standards, and the proposed new language is similar to the plumbing code.

COMMITTEE ACTION: REJECT

COMMITTEE STATEMENT:

The proposal is being rejected as the emitter size varies based on the type of irrigation system installed. Since sizing is not consistent across varying emitter types, the provided new flow path requirement would be overly restrictive and would disallow the use of appropriate emitters.

TOTAL ELIGIBLE TO VOTE: 30

VOTING RESULTS: AFFIRMATIVE: 28 NOT RETURNED: 2 CRAWFORD, WILLIAMS

EXPLANATION OF AFFIRMATIVE:

KENDZEL: I do have concern that we are rejecting text that is similar to what is in the Uniform Plumbing Code. Perhaps the Committee should consider the submittal of a proposal to update the text currently in the UPC.



CODES ADMINISTRATION

Proposals

Item #: 104

WEStand 2023 Section: 603.5, 604.5

SUBMITTER: Billy Smith
Chair, WE-Stand Technical Committee

RECOMMENDATION:
Add new text

603.0 Reclaimed (Recycled) Water Systems.

603.5 Water Pressure. Reclaimed (recycled) water systems supplying water to water closets, urinals, and trap primers shall be capable of delivering not less than 15 pounds-force per square inch (psi) (103 kPa) residual pressure at the highest and most remote outlet served. Where the water pressure in the reclaimed water supply system within the building exceeds 80 psi (552 kPa), a pressure reducing valve reducing the pressure to 80 psi (552 kPa) or less to water outlets in the building shall be installed.

(renumber remaining sections)

604.0 On-Site Treated Nonpotable Water Systems.

604.5 Water Pressure. On-site treated non-potable water systems supplying water to water closets, urinals, and trap primers shall be capable of delivering not less than 15 pounds-force per square inch (psi) (103 kPa) residual pressure at the highest and most remote outlet served. Where the water pressure in the on-site treated non-potable water supply system within the building exceeds 80 psi (552 kPa), a pressure reducing valve reducing the pressure to 80 psi (552 kPa) or less to water outlets in the building shall be installed.

(renumber remaining sections)

SUBSTANTIATION:

Currently the WE•Stand does not address a minimum or maximum water pressure for reclaimed (recycled) water systems and on-site treated non-potable water systems. These systems are used to supply water to water closets, urinals, trap primers for floor drains and floor sinks, above and below ground irrigation, and other uses approved by the Authority Having Jurisdiction. For these reasons, the water pressure requirements should be included for these systems. Lastly, similar language was accepted by the UPC Technical Committee for Item #260 and Item #262.

COMMITTEE ACTION: ACCEPT AS SUBMITTED

TOTAL ELIGIBLE TO VOTE: 30

VOTING RESULTS: AFFIRMATIVE: 28 NOT RETURNED: 2 CRAWFORD, WILLIAMS



CODES ADMINISTRATION

Proposals

Item #: 105

WEStand 2023 Section: 604.7, Table 1201.1

SUBMITTER: Billy Smith
Chair, WE-Stand Technical Committee

RECOMMENDATION:
Revise text

604.0 On-Site Treated Nonpotable Water Systems.

604.7 On-Site Treated Nonpotable Water Devices and Systems. Devices or equipment used to treat on-site treated nonpotable water in order to maintain the minimum water quality requirements determined by the Authority Having Jurisdiction shall be listed ~~or~~ **and** labeled (third-party certified) by a listing agency (accredited conformity assessment body) or approved for the intended application. Devices or equipment used to treat on-site treated nonpotable water for use in water closet and urinal flushing, surface irrigation and similar applications shall ~~be listed or labeled to IAPMO IGC 207, comply with IAPMO IGC 324,~~ NSF/ANSI 350, or **as** approved by the Authority Having Jurisdiction.

**TABLE 1201.1
REFERENCED STANDARDS**

STANDARD NUMBER-YEAR	STANDARD TITLE	REFERENCED SECTION
IAPMO IGC 207-2009a	Reclaimed Water Conservation System for Flushing Toilets	604.7

(portion of table not shown remains unchanged)

Note: IAPMO IGC 324 and NSF/ANSI 350 meet the requirements for mandatory referenced standards in accordance with Section 15.0 of IAPMO's Regulations Governing Consensus Development of the Water Efficiency and Sanitation Standard.

SUBSTANTIATION:

Section 604.7 is being revised to include reference to IAPMO IGC 324 which covers alternate water source systems for multi-family, residential, and commercial use intended to process water from alternate water sources such as gray water, rainwater, stormwater air conditioning condensate, cooling tower makeup, vehicle wash and other nonpotable reuse applications not specifically listed, for use in subsurface and/or surface irrigation and toilet/urinal flushing applications. This standard also specifies requirements for materials, physical characteristics, performance testing, and markings.

It should be noted that IAPMO IGC 324 was built upon the EPA Guidelines for Water Reuse to give the performance protocols for treating nonpotable water (excluding black water) for future non-potable reuse. Additionally, the proposed modifications correlate with the plumbing code. For these reasons, the revisions are beneficial to the WE-Stand.

COMMITTEE ACTION: ACCEPT AS SUBMITTED

TOTAL ELIGIBLE TO VOTE: 30

VOTING RESULTS: AFFIRMATIVE: 28 NOT RETURNED: 2 CRAWFORD, WILLIAMS



CODES ADMINISTRATION

Proposals

Item #: 106

WESand 2023 Section: 604.10.2

SUBMITTER: Kyle Thompson
Plumbing Manufacturers International (PMI)

RECOMMENDATION:
Revise text

604.0 On-Site Treated Nonpotable Water Systems.

604.10 Design and Installation. (remaining text unchanged)

604.10.2 Minimum Water Quality. On-site treated nonpotable water supplied to toilets or urinals or for other uses in which it is sprayed or exposed shall be disinfected. Acceptable disinfection methods shall include chlorination, ultraviolet sterilization, ozone, or other methods as approved by the Authority Having Jurisdiction. The minimum water quality for on-site treated nonpotable water systems shall meet the applicable water quality requirements for the intended applications as determined by the Authority Having Jurisdiction. In addition to nonpotable water supplied to toilets for flushing, a potable water supply line shall be provided to toilets for use in bidets and personal hygiene devices (bidet seats).

SUBSTANTIATION:

A potable water supply is necessary for use with bidets, which require a person to come into direct contact with the water supplied. Users who are immune compromised, have skin lacerations or wounds, or who require the use of a traditional bidet or personal hygiene device (bidet seat) may be at risk if non-potable water is supplied to the bidet.

COMMITTEE ACTION: ACCEPT AS AMENDED BY THE TC

604.0 On-Site Treated Nonpotable Water Systems.

604.10 Design and Installation. (remaining text unchanged)

604.10.2 Minimum Water Quality. On-site treated nonpotable water supplied to toilets or urinals or for other uses in which it is sprayed or exposed shall be disinfected. Acceptable disinfection methods shall include chlorination, ultraviolet sterilization, ozone, or other methods as approved by the Authority Having Jurisdiction. The minimum water quality for on-site treated nonpotable water systems shall meet the applicable water quality requirements for the intended applications as determined by the Authority Having Jurisdiction. ~~In addition to nonpotable water supplied to toilets for flushing, a potable water supply line shall be provided to toilets for use in bidets and~~ Potable water shall be supplied to personal hygiene devices (bidet and bidet seats).

COMMITTEE STATEMENT:

The proposal is being modified to provide needed clarity. The intent of the requirement is to ensure that only potable water is supplied to personal hygiene devices as nonpotable water may pose as a health and safety hazard.

TOTAL ELIGIBLE TO VOTE: 30

VOTING RESULTS: AFFIRMATIVE: 22 NEGATIVE: 6 NOT RETURNED: 2 CRAWFORD, WILLIAMS

EXPLANATION OF AFFIRMATIVE:

BARNES: I agree with the comments that use of the term "potable" unnecessarily limits the water source and that use of any water meeting safe drinking water standards should be considered.

MCLEOD: The intent of this proposal is to ensure human health and safety. As this water will have direct contact with the body, it is important to ensure its safety. Let's get this safety requirement into WE•Stand, and if we the committee need to clarify what type of water constitutes safe, let's do that in the next round. For now, let's ensure we are protecting human health and safety as the priority.

EXPLANATION OF NEGATIVE:

ALLEN: I agree with the other comments and think the water quality should be specified to meet safety requirements.

KLEIN: The requirement should be that the water meets Safe Drinking Water Requirements.

LANDO: The requirement should be that the water meets Safe Drinking Water requirements to allow for reclaimed water. Reclaimed water is sanitized and meets all Safe Drinking Water standards, but is not listed as potable water.

LENGER: Don't like the requirement language of "potable."

PAPE: The requirement should be that the water meets Safe Drinking Water requirements to allow for reclaimed water. Reclaimed water is sanitized and meets all Safe Drinking Water standards, but is not listed as potable water.

SOVOCOOL: In addition to agreeing with the other negative voters, I just think we are begging to erode savings by having another, probably full pressure, connection at the toilet that is potable. When it is time to replace the toilet the temptation to use that potable one will be high. If it was for a low pressure connection this might be a more tenable proposal, but I can't support it as is.



CODES ADMINISTRATION

Proposals

Item #: 107

WEStand 2023 Section: Chapter 8

SUBMITTER: David Gordon
Chair, WE-Stand Onsite Gray Water Treatment Task Group

RECOMMENDATION:
Add new text

CHAPTER 8 **ONSITE GRAY WATER TREATMENT SYSTEMS**

801.0 General.

801.1 Applicability. The provisions of this chapter shall apply to the design, installation, construction, and maintenance of residential and commercial onsite gray water treatment systems for non-potable reuse.

801.2 Allowable Use of Gray Water. Where approved or required by the Authority Having Jurisdiction, treated gray water shall be permitted to be used in lieu of potable water for uses such as, but not limited to, cooling towers, water closets, urinals, clothes washers, and surface irrigation. Gray water systems used for subsoil irrigation shall comply with Section 602.0

802.0 System Design.

802.1 Requirements. Onsite gray water treatment systems shall be designed in accordance with this chapter by a registered design professional. Systems shall meet the design, construction, and performance requirements of Section 802.1.1 or Section 802.1.2.

802.1.1 Listed Devices and Equipment. Devices or equipment used to treat onsite treated gray water in order to maintain the minimum water quality requirements determined by the Authority Having Jurisdiction shall be listed and labeled (third-party certified) by a listing agency (accredited conformity assessment body) or approved for the intended application. Devices or equipment used to treat onsite treated gray water for use in water closet and urinal flushing, surface irrigation and similar applications shall comply with IAPMO IGC 324, NSF/ANSI 350, or as approved by the Authority Having Jurisdiction.

802.1.2 Alternative Design Systems. Where approved by the Authority Having Jurisdiction, onsite gray water treatment systems for residential and commercial applications shall comply with the provisions of Section 802.2 through Section 805.0.

802.2 Permit. It shall be unlawful for any person to construct, install, alter, or cause to be constructed, installed, or altered any onsite gray water treatment system within a building or on a premises without first obtaining a permit to do such work from the Authority Having Jurisdiction.

802.2.1 Plumbing Plan Submission. No permit for any onsite gray water treatment system shall be issued until complete plumbing plans, with appropriate data satisfactory to the Authority Having Jurisdiction, have been submitted and approved.

802.2.2 System Changes. No changes or connections shall be made to either the onsite gray water treatment system or the potable water system without approval by the Authority Having Jurisdiction.

802.3 Component Identification. System components shall be properly identified as to the manufacturer.

802.4 Material Compatibility. Gray water treatment systems shall be constructed of materials that are compatible with the type of pipe and fitting materials, water treatment, and water conditions in the system.

802.5 Log Reduction Targets. Gray water treatment systems shall be designed to meet the log reduction targets as set forth in Table 802.5. To meet the log reduction in Table 802.5, treatment processes used in gray water systems shall comply with Section 802.7 for validation or be operated according to conditions approved by the Authority Having Jurisdiction.

TABLE 802.5
LOG REDUCTION TARGETS FOR 10-4 INFECTIONS PER PERSON PER YEAR BENCHMARKS FOR GRAY
WATER TREATMENT SYSTEMS

WATER USE SCENARIO	ENTERIC VIRUSES	PARASITIC PROTOZOA	ENTERIC BACTERIA
<u>Outdoor Use</u>	<u>5.5</u>	<u>4.5</u>	<u>3.5</u>
<u>Indoor Use</u>	<u>6.0</u>	<u>4.5</u>	<u>3.5</u>

802.6 Effluent Water Quality Parameters. Gray water treatment systems shall be designed to meet the effluent water quality parameters for water closet and urinal fixture use listed in Table 802.6.

TABLE 802.6
EFFLUENT WATER QUALITY PARAMETERS FOR WATER CLOSET AND URINAL FIXTURE USE

	MINIMUM	MAXIMUM
<u>Alkalinity</u>	<u>20 mg/L</u>	<u>200 mg/L</u>
<u>TDS</u>	<u>0 mg/L</u>	<u>500 mg/L</u>
<u>Turbidity</u>	<u>0 NTU</u>	<u>5 NTU</u>
<u>pH</u>	<u>6.0</u>	<u>9.0</u>
<u>Odor</u>	<u>Non-Offensive</u>	
<u>Oily Film and Foam</u>	<u>Visual Non-detectable</u>	
<u>Free Chlorine Residual</u>	<u>N/A</u>	<u>4 ppm</u>
<u>Combined Chlorine</u>	<u>N/A</u>	<u>4 ppm</u>
<u>Chloramines</u>	<u>N/A</u>	<u>4 ppm</u>

802.7 Validation. Where required by the Authority Having Jurisdiction, treatment processes shall be tested to verify the pathogen reduction performance. The treatment processes shall be validated through third-party component validation or field verification using challenge testing. The results of the third-party component validation and/or challenge testing shall be summarized in a validation report prepared by a registered design professional. The validation report shall document the treatment technology's log reduction performance, including information on the operating conditions and surrogate parameters.

802.8 Health and Safety. Gray water shall not create a nuisance or odor, nor threaten human health, or damage the quality of surface water or groundwater.

802.9 Monitoring Requirements. Monitoring of gray water treatment systems shall be based on the risk level in accordance with Table 802.9(1). The parameters listed in Table 802.9(2) shall be monitored by sensors placed in the effluent of the system and connected to a smart controller. The smart controller shall activate an alarm when the parameters in Table 802.9(2) are outside the specifications and shall shut the system down when the alarm is not acknowledged after a period of 8 hours has elapsed. For Category 2, quarterly grab samples shall be taken out of the effluent and analyzed by an accredited lab. The sensors' accuracy and response shall be validated upon commissioning of the system by an independent third party.

TABLE 802.9(1)
RISK LEVELS

RISK LEVEL	TREATED WATER USAGE*
<u>1</u>	<u>Surface Irrigation</u>
<u>2</u>	<u>Water closets, urinals, clothes washers</u>

* See Section 801.2 for other uses approved by the Authority Having Jurisdiction.

**TABLE 802.9(2)
MONITORING PARAMETERS**

CATEGORY	PARAMETERS TO BE MONITORED	VALIDATION PROCEDURE
1	Turbidity. ORP UV intensity (if used)	IGC 324 -Sensor validation procedure using 5.4.1.1 (a), (b), (c), and (d), as applicable
2	Turbidity. ORP UV intensity (if used). pH Quarterly lab Sample for Total Coliform	

802.10 System Requirements. The design and installation of onsite gray water treatment systems shall meet the requirements of Section 802.10.1 through Section 802.10.8.

802.10.1 Connections to Potable or Reclaimed (Recycled) Water Systems. Gray water treatment systems shall have no direct connection to any potable water supply or reclaimed (recycled) water source system. Potable water or reclaimed (recycled) water shall be permitted to be used as makeup water for a gray water treatment system provided the potable or reclaimed (recycled) water supply connection is protected by an airgap.

802.10.2 Bypass Connection. A bypass shall be provided for the input connection to the gray water treatment system. The bypass shall be a diverter valve normally open to the gray water treatment system. The normally closed port of the diverter valve shall be connected directly to the storm drainage system or combined sewer system according to the plumbing code.

802.10.3 Overflow Connection. Gray water treatment overflow shall be connected directly to the plumbing drainage system. The overflow shall be provided with a backwater valve at the point of connection to the plumbing drainage system. The backwater valve shall be accessible for inspection and maintenance.

802.10.4 Near Underground Potable Water Pipe. Onsite treated gray water pipes run or laid in the same trench as potable water pipes shall have 12 inches (305 mm) minimum vertical and horizontal separation when both pipe materials are approved for use within a building. Where piping materials do not meet this requirement the minimum separation shall be increased to 60 inches (1524 mm). The potable water piping shall be installed at an elevation above the onsite treated gray water piping.

802.10.5 Fail-safe Mechanisms. Gray water treatment systems must be equipped with features that result in a controlled and non-hazardous automatic shutdown of the treatment process in the event of a malfunction.

802.10.6 Flow Meter Totalizer. Buildings with gray water treatment systems shall include a flow meter totalizer on the treated gray water distribution system and a flow meter totalizer on the potable make-up water pipeline to the gray water treatment system.

802.10.7 Cross-connection Inspection and Testing. A cross-connection test is required in accordance with Section 601.11.2. Before the building is occupied or the system is activated, the installer shall perform the initial cross-connection test in the presence of the Authority Having Jurisdiction. The test shall be ruled successful by the Authority Having Jurisdiction before final approval is granted.

802.10.8 Water Pressure. Onsite treated non-potable water systems supplying water to water closets, urinals, and trap primers shall be capable of delivering not less than 15 pounds-force per square inch (psi) (103 kPa) residual pressure at the highest and most remote outlet served. Where the water pressure in the onsite treated non-potable water supply system within the building exceeds 80 psi (552 kPa), a pressure reducing valve reducing the pressure to 80 psi (552 kPa) or less to water outlets in the building shall be installed.

803.0 Commissioning.

803.1 General. Onsite gray water treatment systems shall be commissioned in accordance with the requirements of Section 803.1 through Section 803.5.

803.2 Requirements. Commissioning for gray water treatment systems shall be included in the design and construction processes of the project. Commissioning shall be performed by a person who demonstrates competency in commissioning gray water treatment systems as required by the Authority Having Jurisdiction.

803.3 Plan. The construction documents shall include the commissioning plan for the gray water treatment system. The commissioning plan shall be approved by the Authority Having Jurisdiction prior to commissioning the gray water treatment system. The commissioning plan shall include the following:

- (1) General project information.
- (2) Equipment to be tested, including the test methodology.
- (3) Processes to be tested.

- (4) Criteria or process for testing.
- (5) Criteria or process for acceptance.
- (6) Commissioning team contact information.
- (7) Commissioning process activities, schedules, and responsibilities.
- (8) Plans for the completion of functional performance testing, post construction documentation and training, and the commissioning report.

803.4 Performance Testing. Performance tests shall verify that the installation and operation of the equipment of the gray water treatment system is in accordance with the approved plans and specifications. The performance test report shall include the equipment tested, the testing methods utilized, and proof of proper calibration of the equipment.

803.5 Commissioning Report. The commissioning report shall be submitted to the Authority Having Jurisdiction.

804.0 Operation and Maintenance Manual.

804.1 General. An operation and maintenance manual shall be provided in accordance with Section 601.6 and shall also include the following:

- (1) Instructions on operating and maintaining the system, including treatment process operations, instrumentation and alarms, and chemicals storage and handling.
- (2) Site equipment inventory and maintenance notes.
- (3) Equipment/system warranty documentation and information.
- (4) As-Built design drawings.
- (5) Details on training requirements and qualifications of personnel responsible for operating the system.
- (6) Maintenance schedule.

805.0 Inspection.

805.1 General. Field inspections shall take place during and after construction while the contractor is on site to verify that the gray water treatment system components have been properly supplied and installed according to the plans and specifications used for installation. Record drawings shall be maintained with changes to the approved plans by the contractor and available for periodic inspection as needed.

(renumber remaining chapters)

Note: IAPMO IGC 324 and NSF/ANSI 350 meet the requirements for mandatory referenced standards in accordance with Section 15.0 of IAPMO's Regulations Governing Consensus Development of the Water Efficiency and Sanitation Standard.

SUBSTANTIATION:

The Onsite Gray Water Treatment Task Group proposes comprehensive requirements related to the water quality, monitoring, design, construction, commissioning, alteration, repair, and operation requirements of onsite gray water treatment systems for non-potable water reuse. These requirements for a properly designed system, together with appropriate construction, operation, and maintenance, will help ensure onsite gray water treatment systems will be implemented safely and reliably. Similar requirements are currently published in the most recent edition of the WE•Stand for stormwater and black water systems.

The Task Group proposes to incorporate health risk-based water quality requirements for onsite gray water treatment systems. The risk-based water quality approach was developed through recent research by the National Water Research Institute (NWRI) and the Water Research Foundation (WRF), culminating in the report Risk-Based Framework for the Development of Public Health Guidance for Decentralized Non-Potable Water Systems. Utilizing similar methodology as is employed in potable reuse and drinking water regulations, the risk-based LRTs align with the Water Safety Plan approach promoted by the World Health Organization. Gray water may contain pathogenic microorganisms that, if not properly treated, can cause infection due to exposure to these waters when recycled and used onsite. The intent of the risk-based framework is to determine the appropriate level of treatment for pathogens that are needed to protect public health, accounting for such factors as the source water quality, specific end use, and acceptable risk of infection from exposure to the treated water. The risk threshold used for this application is the same as has been previously applied in the context of municipal drinking water, i.e. exposure to this water via toilet flushing, irrigation, and other non-potable uses poses no greater risk than drinking municipally supplied drinking water.

Because the amount of pathogen reduction for reuse usually spans orders of magnitude, pathogen treatment requirements are specified in terms of log₁₀ reduction; 1-log₁₀ reduction equates to 90% removal, 2-log₁₀ reduction to 99% removal, 3-log₁₀ reduction to 99.9% removal, and so on. The treatment requirements developed using the risk-based methodology in this case are called log reduction targets, or LRTs. The LRTs were developed using a Quantitative Microbial Risk Assessment (QMRA). QMRA is a scientific approach to estimating the potential human

health risks associated with exposure to microbial hazards (in this case, human pathogenic viruses, bacteria, and protozoa). LRTs for gray water reuse for unrestricted irrigation and toilet flushing were developed based on the annual risk level of 10⁻⁴ infections per person per year. Unit treatment processes that are effective at removing and/or inactivating pathogens can be used to meet the LRTs. In most cases, several unit processes are needed in series to provide sufficient treatment. The ability of unit processes to provide a certain level of treatment is verified through the use of ongoing monitoring and, in some cases, validation. For some unit processes, validation is critical to determine how the process can be used to achieve the LRTs.

The Task Group also proposes to incorporate a monitoring approach for onsite gray water treatment systems that aligns with the research. The framework for monitoring deviates from traditional approaches of monitoring fecal indicator organisms (FIOs) in grab samples because there are recognized limitations of using FIOs. The primary limitation of FIO monitoring is that it cannot be done continuously to ensure safe water is delivered to the end use at all times. Rather, the Task Group is proposing continuous water quality monitoring of surrogate parameters such as turbidity, residual chlorine, ultraviolet transmittance, and others to verify that treatment processes are operating as designed.

The Task Group supports the use of a health risk-based approach to guide treatment and design requirements for onsite gray water treatment systems because it ensures that systems implemented using this framework are safe and reliable. The requirements being proposed are intended to ensure that public health is protected while still allowing for flexibility in design, as it does not prescribe that specific treatment processes must be used. It should be noted that several states have recently moved forward to adopt the risk-based framework at the state level. Much of this work has been driven by the work of the National Blue Ribbon Commission for Onsite Non-potable Water Systems, a coalition of public health agencies and water and wastewater utilities committed to advancing the safe, practical, and sustainable implementation of alternate water source systems. As a result of the Commission's work, several states including California, Colorado, Minnesota, Oregon, Washington, and Hawaii are proposing legislation to adopt the risk-based approach. Therefore, institutionalizing the risk-based approach in WE-Standard will create further consistency across the country by aligning plumbing and health code requirements for alternate water source systems.

The following resources were used to develop the proposed text for onsite gray water treatment systems:

Risk-Based Framework for the Development of Public Health Guidance for Decentralized Non-Potable Water Systems:

https://www.nwri-usa.org/_files/ugd/632dc3_8831385f1c2f4bb1b2976b06719832ae.pdf?index=true

A Guidebook for Developing and Implementing Regulations for Onsite Non-potable Water Systems developed by the National Blue Ribbon Commission for Onsite Non-Potable Water Systems:

<http://uswateralliance.org/sites/uswateralliance.org/files/NBRC%20GUIDEBOOK%20FOR%20DEVELOPING%20ONWS%20REGULATIONS.pdf>

San Francisco Department of Public Health Director's Rules and Regulations Regarding the Operation of Alternate Water Source Systems:

https://www.sfdph.org/dph/files/EHSdocs/ehsWaterdocs/NonPotable/SFHC_12C_Rules.pdf

COMMITTEE ACTION: ACCEPT AS SUBMITTED

TOTAL ELIGIBLE TO VOTE: 30

VOTING RESULTS: AFFIRMATIVE: 16 NEGATIVE: 9 ABSTAIN: 3 NOT RETURNED: 2 CRAWFORD, WILLIAMS

Note: Item # 107 failed to achieve the necessary two-thirds affirmative vote of returned ballots. In accordance with Section 6.8.2 of the Regulations Governing Consensus Development of the Water Efficiency and Sanitation Standard, a public comment is requested for this proposal. The Technical Committee will reconsider this proposal as a public comment.

EXPLANATION OF NEGATIVE:

BRABAND: Concur with Thomas Pape.

KLEIN: I agree with Thomas Pape and Markus Lenger.

KOELLER: Concur with Mr. Thomas Pape's comments.

LANSING: Further revisions are needed prior to incorporating this into WE•Stand.

LENGER: Scientifically inaccurate - comparing apples to oranges.

PAPE: The use of log reductions for water quality requirements is completely useless unless it is used with pre-treatment water quality requirements. It ignores that fact that black water and rainwater will have radically different resulting qualities while both meet these log reductions. Stop this insanity!!

PREMER: Based on the comments, more discussion is needed.

TABAKH: This should be referred back to Task Group to address the concerns.

WHITE: I agree with concerns for log reductions as basis of water quality.

EXPLANATION OF ABSTAIN:

BARNES: Based on the comments, I agree that more discussion on this topic is needed.

CUDAHY: Based on the comments, I agree that more discussion on this topic is needed.

MCLEOD: More detailed discussion is needed to move forward.



CODES ADMINISTRATION

Proposals

Item #: 108

WEStand 2023 Section: Chapter 9

SUBMITTER: Billy Smith
Chair, WE-Stand Technical Committee

RECOMMENDATION:
Revise text

901.0 General.

901.1 Scope. The provisions of this chapter shall apply to the installation, construction, alteration, and repair of nonpotable rainwater catchment systems.

901.1.1 Allowable Use of Rainwater. Where approved or required by the Authority Having Jurisdiction, rainwater shall be permitted to be used in lieu instead of potable water shall be in accordance with the provisions of for the applications identified in this chapter.

901.7 Minimum Water Quality Requirements. The minimum water quality for rainwater catchment systems shall meet the applicable water quality requirements for the intended application as determined by the Authority Having Jurisdiction. Water quality for nonpotable rainwater catchment systems shall comply with Section 903.4.

Exceptions:

- (1) Water treatment is not required for rainwater catchment systems used for aboveground irrigation with a maximum storage capacity of 360 gallons (1363 L).
- (2) Water treatment is not required for rainwater catchment systems used for nonspray subsurface or drip irrigation.

901.9 System Controls. Controls for pumps, valves, and other devices that contain mercury that come in contact with rainwater supply are prohibited shall not be permitted.

901.10 Separation Requirements. All underground rainwater catchment service piping shall be separated from the building sewer in accordance with the plumbing code. Treated nonpotable water pipes shall be permitted to be run or laid in the same trench as potable water pipes shall have with a 12 inch (305 mm) minimum vertical and horizontal separation when both pipe materials are approved for use within a building. Where horizontal piping materials do not meet this requirement the minimum separation shall be increased to 60 inches (1524 mm). The potable water piping shall be installed at an elevation above the treated nonpotable water piping.

901.11 Abandonment. All rainwater catchment systems that are no longer in use or fails to be maintained in accordance with Section 901.5 shall be abandoned. Abandonment shall comply with Section 305.0-901.11.1 and Section 901.11.2.

901.11.1 General. An abandoned system or part thereof covered under the scope of this chapter shall be disconnected from the remaining systems, drained, plugged, and capped in an approved manner. All rainwater catchment systems that are no longer in use or fails to be maintained in accordance with Section 901.5 shall be abandoned.

901.11.2 Underground Tank. An underground water storage tank that has been abandoned or otherwise discontinued from use in a system covered under the scope of this chapter shall be completely drained and filled with earth, sand, gravel, concrete, or other approved material or removed in a manner satisfactory to the Authority Having Jurisdiction.

902.0 Nonpotable Rainwater Catchment Systems.

902.1 General. The provisions of this section shall apply to the installation, construction, alteration, and repair of rainwater catchments systems intended to supply uses such as water closets, urinals, trap primers for floor drains and floor sinks, irrigation, industrial processes, water features, cooling tower makeup and other uses approved by the Authority Having Jurisdiction. Additional design criteria can be found in the Rainwater catchment systems for collecting precipitation or rain from rooftops shall comply with ARCSA/ASPE 63-~~Standard~~.

902.2 Plumbing Plan Submission. No permit for any rainwater catchment system ~~requiring a permit~~ shall be issued until complete plumbing plans, with appropriate data satisfactory to the Authority Having Jurisdiction, have been submitted and approved.

902.8 Rainwater Catchment ~~Water~~ System Color and Marking Information. (remaining text unchanged)

~~903.2902.9 Deactivation and Drainage for Cross-connection Test. Where any portion of a rainwater catchment system is installed within a building,~~ The rainwater catchment system and the potable water system within the building shall be provided with the required appurtenances (e.g., valves, air or vacuum relief valves, etc.) to allow for deactivation or drainage as required for a cross-connection test in Section 903.14.2.

SUBSTANTIATION:

The revisions and additions to Chapter 9 (Nonpotable Rainwater Catchment Systems) provide necessary improvements for clarity and enforceability of provisions. All modifications correlate with the plumbing code.

Additionally, Section 901.11 (Abandonment) has been updated to include necessary information for abandonment of nonpotable rainwater catchment systems. Although this language appears in Chapter 3 (General Regulations), it is important to also provide such requirements within Chapter 9. For these reasons, the proposed modifications improve the WE•Stand and should be included.

COMMITTEE ACTION: REJECT

COMMITTEE STATEMENT:

The proposal is being rejected as the existing language is preferred. The language gathered from Section 305.0 (Abandonment) applies to all systems addressed within the standard and therefore does not need to be repeated. There is also concern with the varying interpretations of the term "abandonment." The Technical Committee agrees that a definition for "abandonment" would be beneficial within the WE•Stand.

Additionally, Section 902.1 only references ARCSA/ASPE 63, and the Technical Committee prefers that other applicable industry standards be referenced for nonpotable rainwater catchment systems.

TOTAL ELIGIBLE TO VOTE: 30

VOTING RESULTS: AFFIRMATIVE: 27 NEGATIVE: 1 NOT RETURNED: 2 CRAWFORD, WILLIAMS

EXPLANATION OF NEGATIVE:

SOVOCOOL: I think the author is probably right in recognizing that more detail on what to do for abandonment will help water purveyors have more comfort with going this direction.



CODES ADMINISTRATION

Proposals

Item #: 109

WEStand 2023 Section: 903.1, 903.4, 903.4.1

SUBMITTER: Billy Smith
Chair, WE-Stand Technical Committee

RECOMMENDATION:
Revise text

903.0 Design and Installation.

903.1 Rainwater Catchment Systems. ~~The design and installation of nonpotable rainwater catchment systems shall be in accordance with Section 903.2 through Section 903.14.~~

(renumber remaining sections)

903.4 Minimum Water Quality. The minimum water quality for harvested rainwater shall meet the applicable water quality requirements for the intended applications as determined by the Authority Having Jurisdiction. In the absence of water quality requirements determined by the Authority Having Jurisdiction, the minimum treatment and water quality shall ~~also comply be in accordance~~ with Table 903.4, ~~IAPMO IGC 324, or NSF/ANSI 350.~~

Exception: No treatment is required for rainwater used for subsurface or nonsprinkled surface irrigation where the maximum storage volume is less than 360 gallons (1363 L).

~~**903.4.1 Treatment.** If the quality of the tested water cannot consistently be maintained at the minimum levels specified in Table 903.4, then the system shall be equipped with an appropriate treatment device meeting applicable NSF Standard referenced in Table 1201.1.~~

Note: IAPMO IGC 324 and NSF/ANSI 350 meet the requirements for mandatory referenced standards in accordance with Section 15.0 of IAPMO's Regulations Governing Consensus Development of the Water Efficiency and Sanitation Standard.

SUBSTANTIATION:

The revisions and additions to Chapter 9 (Nonpotable Rainwater Catchment Systems) provide necessary improvements for both clarity and inclusion of applicable industry standards. All modifications correlate with the plumbing code.

Section 903.1 (Rainwater Catchment Systems) is being added to ensure that all nonpotable rainwater catchment systems are designed and installed in compliance with Section 903.2 through 903.14. These subsections of 903.0 address hose bibbs, appurtenances, collection surfaces, water quality, storage tanks, pumps, markings, and a variety of other design and installation requirements.

In Section 903.4 (Minimum Water Quality), IAPMO IGC 324 and NSF/ANSI 350 are being added as they both include water quality parameter requirements applicable to the systems addressed within Chapter 9.

As noted in previous items, IAPMO IGC 324 covers alternate water source systems for multi-family, residential, and commercial use intended to process water from alternate water sources such as greywater, rainwater, stormwater air conditioning condensate, cooling tower makeup, vehicle wash and other nonpotable reuse applications not specifically listed, for use in subsurface and/or surface irrigation and toilet/urinal flushing applications, and specifies requirements for materials, physical characteristics, performance testing, and markings. Additionally, NSF/ANSI 350 has been included as it contains minimum requirements for onsite residential and commercial water reuse treatment systems.

COMMITTEE ACTION: ACCEPT AS SUBMITTED

TOTAL ELIGIBLE TO VOTE: 30

VOTING RESULTS: AFFIRMATIVE: 27 NOT RETURNED: 3 CRAWFORD, MCLEOD, WILLIAMS



CODES ADMINISTRATION

Proposals

Item #: 110

WEStand 2023 Section: 903.5 - 903.5.2, 903.5.4, 903.9, Table 1201.1

SUBMITTER: Billy Smith
Chair, WE-Stand Technical Committee

RECOMMENDATION:
Revise text

903.0 Design and Installation.

903.5 Rainwater Storage Tanks. Rainwater storage tanks shall ~~comply with IAPMO/ANSI Z1002 be constructed~~ and ~~be~~ installed in accordance with Section 903.5.1 through Section ~~903.5-8903.5.7~~.

~~**903.5.1 Construction.** Rainwater storage shall be constructed of solid, durable materials not subject to excessive corrosion or decay and shall be watertight. Storage tanks shall be approved by the Authority Having Jurisdiction, provided such tanks comply with approved applicable standards.~~

~~**903.5-2903.5.1 Location.** Rainwater storage tanks shall be permitted to be installed above or below grade.~~

(renumber remaining sections)

903.5.4 Below Grade. Rainwater storage tanks installed below grade shall be structurally designed to withstand all anticipated earth or other loads. Holding tank covers shall be capable of supporting an earth load of not less than 300 pounds per square foot (lb/ft²) (1465 kg/m²) when the tank is designed for underground installation. Below grade rainwater tanks installed underground shall be provided with manholes. The manhole opening shall not be less than 20 inches (508 mm) in diameter and located not less than 4 inches (102 mm) above the surrounding grade. The surrounding grade shall be sloped away from the manhole. Underground tanks shall be ballasted, anchored, or otherwise secured, to prevent the tank from floating out of the ground when empty. The combined weight of the tank and hold down system ~~should~~shall meet or exceed the buoyancy force of the tank.

903.9 Freeze Protection. Tanks and piping installed in locations subject to freezing shall be provided with an ~~adequate~~approved means of freeze protection.

**TABLE 1201.1
REFERENCED STANDARDS**

STANDARD NUMBER- YEAR	STANDARD TITLE	REFERENCED SECTION
IAPMO/ANSI Z1002- 2020*	Rainwater Harvesting Tanks	903.5

(portion of table not shown remains unchanged)

Note: IAPMO/ANSI Z1002 meets the requirements for a mandatory referenced standard in accordance with Section 15.0 of IAPMO's Regulations Governing Consensus Development of the Water Efficiency and Sanitation Standard.

SUBSTANTIATION:

The revisions and additions to Chapter 9 (Nonpotable Rainwater Catchment Systems) provide necessary improvements for both clarity and inclusion of applicable industry standards. All modifications correlate with the plumbing code.

Section 903.5 (Rainwater Storage Tanks) is being modified to reference IAPMO Z1002 as this standard covers rainwater harvesting tanks and specifies requirements for design, materials, manufacture, performance, testing, and markings. Section 903.5.4 and Section 903.9 are being revised to remove unenforceable language from the mandatory body of the code.

COMMITTEE ACTION: REJECT

COMMITTEE STATEMENT:

Requiring compliance with IAPMO/ANSI Z1002 is unnecessary and overly restrictive as it would limit the design and installation of rainwater harvesting tanks. There currently exists a variety of manufactured water storage tanks which are appropriate for use in rainwater catchment systems and are not listed to IAPMO/ANSI Z1002. Additionally, there is concern regarding the availability of manufactured rainwater harvesting tanks currently listed to this standard.

TOTAL ELIGIBLE TO VOTE: 30

VOTING RESULTS: AFFIRMATIVE: 20 NEGATIVE: 8 NOT RETURNED: 2 CRAWFORD, WILLIAMS

EXPLANATION OF NEGATIVE:

BARNES: I agree that the use of product standards is appropriate.

CUDAHY: I agree with Jim Kendzel.

KENDZEL: The Committee substantiation goes against the basic philosophy of model codes and the use of national product consensus standards and third-party verification. Rainwater storage tanks are a critical component of rainwater catchment systems, and it is important to have nationally accepted standards that provide minimum requirements and third-party validation of those requirements. The thought that there are already products in the field performing well does not seem to provide justification for not requiring listing to minimum design and performance standards.

KLEIN: I agree with Jim Kendzel.

KOELLER: I concur with the comments of Mr. Jim Kendzel and therefore change my vote.

PREMER: I agree with Jim Kendzel as well, but adding, as this technology matures and more manufacturers make "tanks," it is even more important to protect our systems. Thus, mandating adherence to basic standards.

SMITH: I agree that the use of product standards is appropriate.

WHITE: I agree that the use of product standards is appropriate.



CODES ADMINISTRATION

Proposals

Item #: 111

WEStand 2023 Section: 903.13, Table 1201.1

SUBMITTER: Billy Smith
Chair, WE-Stand Technical Committee

RECOMMENDATION:
Add new text

903.0 Design and Installation.

903.13 Rainwater Diversion Valves. Rainwater diversion valves ranging from 2 inches (50 mm) through 4 inches (100 mm) in diameter shall comply with IAPMO PS 59. Rainwater diversion valves ranging from 6 inches (150 mm) to 12 inches (300 mm) in diameter shall comply with IAPMO IGC 352. Valves shall be accessible and include a filter located upstream of the valve when required.

(renumber remaining sections)

**TABLE 1201.1
REFERENCED STANDARDS**

STANDARD NUMBER-YEAR	STANDARD TITLE	REFERENCED SECTION
IAPMO IGC 352-2020^{e1}	Diverter/Bypass Valves for use in Alternate Nonpotable Water Source Systems	903.13
IAPMO PS 59-2016a^{e2}	Wastewater Diverter/Bypass Valves and Diversion Systems	903.13

(portion of table not shown remains unchanged)

Note: IAPMO IGC 352 and IAPMO PS 59 meet the requirements for mandatory referenced standards in accordance with Section 15.0 of IAPMO’s Regulations Governing Consensus Development of the Water Efficiency and Sanitation Standard.

SUBSTANTIATION:

This addition to Chapter 9 (Nonpotable Rainwater Catchment Systems) provides necessary improvements for both clarity and inclusion of applicable industry standards. Similar language was also accepted by the UPC Technical Committee for Item #259. Section 903.13 (Rainwater Diversion Valves) is being added to address diverter valves and their appropriate locations and sizing. Additionally, IAPMO PS 59 and IAPMO IGC 352 are being referenced as the applicable industry standards for such valves.

IAPMO PS 59 covers wastewater diverter/bypass valves and diversion systems and specifies requirements for materials, physical characteristics, performance testing, and markings. Wastewater diverter/bypass valves covered by this standard can be used in alternate water source systems for indoor and outdoor non-potable uses.

IAPMO IGC 352 covers valves specifically designed to divert high flows of non-potable water including, but not limited to, rainwater, stormwater, and gray water. Additionally, this standard addresses the special need for alternative large diameter valves for use with alternate water source systems, which cannot be practically met by existing valve designs compliant with IAPMO PS 59. For these reasons, the inclusion of both standards is necessary.

COMMITTEE ACTION: REJECT

COMMITTEE STATEMENT:

Requiring compliance with these standards adds unnecessary barriers to rainwater systems. There are concerns that certifications which are specific to rainwater catchment systems are unnecessary. Components listed for potable water applications are appropriate for such use and should also be permitted.

There is also concern regarding the limited availability of products in compliance with IAPMO IGC 352 and IAPMO PS 59. Additionally, rainwater diversion valves do not pose a health and safety risk where in noncompliance with these standards. For these reasons, the item is being rejected.

TOTAL ELIGIBLE TO VOTE: 30

VOTING RESULTS: AFFIRMATIVE: 28 NOT RETURNED: 2 CRAWFORD, WILLIAMS

EXPLANATION OF AFFIRMATIVE:

KENDZEL: I am in support of the Committee's decision to reject based on the fact there appears to already exist product standards covering these products that are applicable for rainwater systems. I would suggest that the existing standards be added to WE•Stand since, I believe, it is important to reference the applicable national product standards when they exist.



CODES ADMINISTRATION

Proposals

Item #: 112

WEStand 2023 Section: 903.13.1 - 903.13.2

SUBMITTER: Billy Smith
Chair, WE-Stand Technical Committee

RECOMMENDATION:
Revise text

903.0 Design and Installation.

903.13 Signs. (remaining text unchanged)

903.13.1 Commercial, Industrial, and Institutional Restroom Signs. A sign shall be installed in all restrooms in commercial, industrial, and institutional occupancies using nonpotable rainwater for water closets, urinals, or both. Each sign shall contain ½ inch (12.7 mm) letters of a highly visible color on a contrasting background. The location of the sign(s) shall be such that the sign(s) shall be visible to all users. The number and location of the sign(s) shall be approved by the Authority Having Jurisdiction and shall contain the following text:

TO CONSERVE WATER, THIS BUILDING USES RAINWATER TO FLUSH TOILETS AND URINALS.

903.13.2 Equipment Room Signs. Each equipment room containing nonpotable rainwater equipment shall have a sign posted ~~in a location that is visible to anyone working on or near nonpotable water equipment~~ with the following wording in 1 inch (25.4 mm) letters:

CAUTION: NONPOTABLE RAINWATER, DO NOT DRINK. DO NOT CONNECT TO DRINKING WATER SYSTEM.
NOTICE: CONTACT BUILDING MANAGEMENT BEFORE PERFORMING ANY WORK ON THIS WATER SYSTEM.

This sign shall be posted in a location that is visible to anyone working on or near rainwater equipment.

SUBSTANTIATION:

The revisions to Section 903.13.1 are needed to specify that the signage applies to nonpotable rainwater usage. Additionally, the revisions to Section 903.13.2 ensure that all equipment rooms have appropriate signage. The proposed modifications are also consistent with the plumbing code.

COMMITTEE ACTION: ACCEPT AS AMENDED BY THE TC

903.0 Design and Installation.

903.13 Signs. (remaining text unchanged)

903.13.1 Commercial, Industrial, and Institutional Restroom Signs. A sign shall be installed in all restrooms in commercial, industrial, and institutional occupancies using nonpotable rainwater for water closets, urinals, or both. Each sign shall contain not less than ½ inch (12.7 mm) letters of a highly visible color on a contrasting background. The location of the sign(s) shall be such that the sign(s) shall be visible to all users. The number and location of the sign(s) shall be approved by the Authority Having Jurisdiction and shall contain the following text:

TO CONSERVE WATER, THIS BUILDING USES RAINWATER TO FLUSH TOILETS AND URINALS.

903.13.2 Equipment Room Signs. Each equipment room containing nonpotable rainwater equipment shall have a sign posted with the following wording in not less than 1 inch (25.4 mm) letters:

CAUTION: NONPOTABLE RAINWATER, DO NOT DRINK. DO NOT CONNECT TO DRINKING WATER SYSTEM.
NOTICE: CONTACT BUILDING MANAGEMENT BEFORE PERFORMING ANY WORK ON THIS WATER SYSTEM.

This sign shall be posted in a location that is visible to anyone working on or near rainwater equipment.

COMMITTEE STATEMENT:

The current language requires restroom signage to use 1/2 inch lettering rather than providing a minimum size. The same applies to the requirement for equipment room signage which specifies 1 inch size lettering. To mitigate this issue, the proposal is being amended to specify that the provided sizing is the minimum rather than the only permitted size.

The Technical Committee also wishes to make an editorial revision to Item #096 for consistency with the phrasing, "not less than," as used within this item when referring to a minimum value.

TOTAL ELIGIBLE TO VOTE: 30

VOTING RESULTS: AFFIRMATIVE: 28 NOT RETURNED: 2 CRAWFORD, WILLIAMS



CODES ADMINISTRATION

Proposals

Item #: 113

WEStand 2023 Section: 210.0, 1003.7

SUBMITTER: Jim Kendzel
Chair, WE-Stand Premise Water Supply System Design Task Group

RECOMMENDATION:
Add new text

1003.0 Service Hot Water – Low-Rise Residential Buildings.

1003.7 Maximum Hot Water System Ratio. The ratio of the hot water system rectangle to the floor area shall not exceed 60 percent for single-story dwellings and shall not exceed 30 percent for dwellings two or more stories in height. These ratios shall apply to both attached and detached dwelling units.

(renumber remaining sections)

210.0 - H -

Hot Water System Ratio. The ratio of the hot water system rectangle to the floor area of a dwelling.
Hot Water System Rectangle. The region of a dwelling that bounds the water heater, plumbing fixture fittings, and appliances which use hot water.

SUBSTANTIATION:

This "maximum hot water system ratio" is intended to promote efficient floor plan layouts to limit heating energy and water-use. Inefficient fixture locations will have long hot water wait times, resulting in greater water use and heating energy with no benefit to the user. The values of 60% and 30% here are achievable in common fixture arrangements in most dwellings, while prohibiting the most inefficient layouts.

In the below example, the red rectangle is drawn to match the boundary of where all fixtures are located. The green rectangles represent the portions of the dwelling where there are no fixtures located. When accounting for the red area with respect to the total of the green and red areas, it can be seen that 67% of this dwelling is covered by the red area, meaning plumbing fixtures are spread throughout 67% of the dwelling.

The "hot water system rectangle" is correlated to the amount of piping that will be used, which is also correlated to the volume between the water heater, or circulated piping in the case of a multifamily dwelling, to the fixture.

In support of the proposed new requirements, terminology has also been provided for "hot water system ratio" and "hot water system rectangle." Including these definitions aids users of the WE•Stand by offering an explanation of terms used.

Example: 1 story, 3BR/2BA, 1697 sqft (Fresno, CA) ~ 67% (1137 sqft)

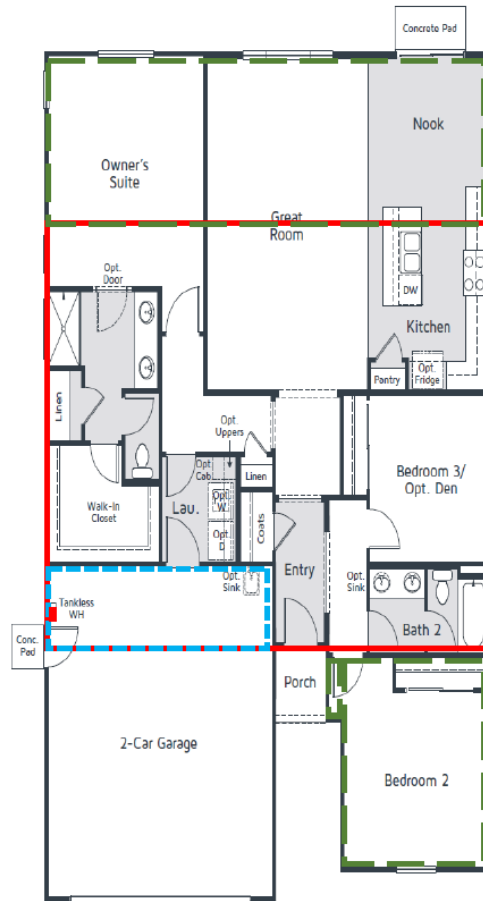

COMMITTEE ACTION: ACCEPT AS SUBMITTED

TOTAL ELIGIBLE TO VOTE: 30

VOTING RESULTS: AFFIRMATIVE: 27 NEGATIVE: 1 NOT RETURNED: 2 CRAWFORD, WILLIAMS

EXPLANATION OF NEGATIVE:

WHITE: The rationale says that there is no benefit to users for exceeding this area; that is in the proponent's opinion. Users may indeed derive some benefit that they value. The 60% for single story and 30% for 2 stories or more is confusing. Are we really talking about the footprint?

A 1000 ft² single story would be allowed 600 ft², but a two story at 1000 ft² per floor gets 600 ft². Is that on two floors? Does a three story at 1000 ft² per floor get 900 ft²? Is that the footprint, or all floors in the rectangle? I believe this needs more work.



CODES ADMINISTRATION

Proposals

Item #: 114

WEStand 2023 Section: 1005.4.1 - 1005.4.2

SUBMITTER: David Dee Dexter, PE, FASPE, FNSPE, CPD, CPI, CPE
3D Engineering Consultants, LLC

RECOMMENDATION:
Revise text

1005.0 Mandatory Provisions.

1005.4 Hot Water System Design.

1005.4.1 Recirculation Systems. Recirculation systems shall meet the provisions in Section 1002.0. Circulating hot water systems shall be arranged so that the circulating pump(s) are capable of being turned off (automatically or manually) where the hot water system is not in operation.

Exception: For health facilities, long-term care facilities, hotels, or motels, devices that automatically turn off the recirculation pump(s) shall not be required.

1005.4.2 Controls. Where used to maintain storage tank water temperature, circulating pump(s) shall be equipped with controls limiting operation to a period from the start of the heating cycle to a maximum of 5 minutes after the end of the heating cycle.

(renumber remaining sections)

SUBSTANTIATION:

As public health and safety is the prime objective of any code, a balance between these various codes sometimes becomes necessary. The concern for Legionella has a higher priority than the minimal amount of energy saved by running a small circulating pump. Hence, within certain facilities it is necessary to maintain an elevated water temperature throughout the entire domestic hot water system, supply and return. This exception allows the circulating pump to operate continuously. It has been and continues to be standard practice to continuously operate these circulating pumps to maintain a minimum temperature throughout the system.

COMMITTEE ACTION: REJECT

COMMITTEE STATEMENT:

The proposed language is overly restrictive and inconsistent with normal practices for circulating hot water systems. In particular, Section 1005.4.2 (Controls) would prevent the use of common and appropriate methods for controlling and maintaining storage tank water temperatures. Additionally, there is concern regarding possible conflict with current ASHRAE standards. For these reasons, the item is being rejected.

TOTAL ELIGIBLE TO VOTE: 30

VOTING RESULTS: AFFIRMATIVE: 28 NOT RETURNED: 2 CRAWFORD, WILLIAMS



CODES ADMINISTRATION

Proposals

Item #: 115

WEStand 2023 Section: A 101.2, A 101.7, Table 1201.1

SUBMITTER: Billy Smith
Chair, WE-Stand Technical Committee

RECOMMENDATION:
Revise text

A 101.0 General.

A 101.2 System Design. Potable rainwater catchment systems complying with this appendix shall be designed by a ~~registered design professional person registered, licensed, or person~~ deemed competent by the Authority Having Jurisdiction to perform potable rainwater catchment system design work. Where required, rainwater catchment systems shall be seismically restrained against earthquakes in accordance with the building code.

A 101.7 Minimum Water Quality Requirements. The minimum water quality for all potable rainwater catchment systems shall meet the applicable water quality requirements as determined by the Authority Having Jurisdiction ~~for private wells.~~ In the absence of water quality requirements, EPA/600/R-12/618 contains recommended water reuse guidelines to assist regulatory agencies develop, revise, or expand alternate water source water quality standards.

**TABLE 1201.1
REFERENCED STANDARDS**

STANDARD NUMBER-YEAR	STANDARD TITLE	REFERENCED SECTION
EPA/625/R-04/108-2004 EPA/600/R-12/618-2012	Guidelines for Water Reuse	601.7, A 101.7

(portion of table not shown remains unchanged)

Note: EPA/600/R-12/618 does not meet the requirements for a mandatory referenced standard in accordance with Section 15.0 of IAPMO's Regulations Governing Consensus Development of the Water Efficiency and Sanitation Standard.

SUBSTANTIATION:

The revisions to Section A 101.2 are needed to clarify that design must be completed by a registered design professional or person deemed competent by the AHJ. As defined in Chapter 2, a "registered design professional" is an individual who is registered or licensed by the laws of the state to perform such design work in the jurisdiction. Using the term "registered design professional" is also consistent with the language used in the remainder of the WE•Stand. For consistency and clarity, this change should be implemented. Furthermore, the new requirement for rainwater catchment systems to be seismically restrained offers a level of safety in the event of an earthquake. The proposed modifications are also consistent with the plumbing code.

Section A 101.7 has also be updated to include the most recent edition of EPA's Guideline for Water Reuse. EPA/600/R-12/618 is a comprehensive, up-to-date document which provides water reuse guidelines in support of regulations developed by states, tribes, and other authorities. Due to significant growth in the application of reuse and important advances in reuse technologies, such guidelines are needed which specify minimum water quality to promote health and safety.

COMMITTEE ACTION: ACCEPT AS AMENDED BY THE TC

A 101.0 General.

A 101.2 System Design. Potable rainwater catchment systems complying with this appendix shall be designed by a registered design professional or person deemed competent by the Authority Having Jurisdiction to perform potable rainwater catchment system design work. Where required, rainwater catchment systems shall be seismically restrained against earthquakes in accordance with the building code.

A 101.7 Minimum Water Quality Requirements. The minimum water quality for all potable rainwater catchment systems shall meet the applicable water quality requirements as determined by the Authority Having Jurisdiction for private wells. ~~In the absence of water quality requirements, EPA/600/R-12/618 contains recommended water reuse guidelines to assist regulatory agencies develop, revise, or expand alternate water source water quality standards.~~

**TABLE 1201.1
REFERENCED STANDARDS**

STANDARD NUMBER- YEAR	STANDARD TITLE	REFERENCED SECTION
EPA/600/R-12/618-2012	Guidelines for Water Reuse	601.7, A 101.7

(portion of table not shown remains unchanged)

COMMITTEE STATEMENT:

The modification retains the current language in Section A 101.7 as the addition of EPA/600/R-12/618 does not improve the section and would only be applicable in the absence of water quality requirements.

TOTAL ELIGIBLE TO VOTE: 30

VOTING RESULTS: AFFIRMATIVE: 28 NOT RETURNED: 2 CRAWFORD, WILLIAMS



CODES ADMINISTRATION

Proposals

Item #: 116

WEStand 2023 Section: A 101.9, A 103.1 - A 103.2

SUBMITTER: Billy Smith
Chair, WE-Stand Technical Committee

RECOMMENDATION:
Revise text

A 101.0 General.

A 101.9 System Controls. Controls for pumps, valves, and other devices that contain mercury that come in contact with the water supply ~~are prohibited shall be prohibited~~.

A 103.0 Potable Rainfall Catchment System Materials.

A 103.1 Collections Surfaces. The collection surface for potable applications shall be constructed of a hard, impervious material and shall be approved for potable water use. ~~Roof e~~Coatings, paints, and liners placed on roof tops and ground surfaces which come into direct contact with rainwater shall comply with NSF Protocol P151.

A 103.1.1 Prohibited. Roof paints and coatings with lead, chromium, or zinc ~~are prohibited shall be prohibited~~. Wood roofing material and lead flashing ~~are prohibited shall be prohibited~~.

A 103.2 Rainwater Catchment System Drainage Materials. ~~Gutters and downspouts used in rainwater catchment drainage systems shall comply with NSF Protocol P151, and leaders and conductors shall be listed to NSF 61. Materials used in rainwater catchment drainage systems, including gutters, downspouts, conductors, and leaders shall be in accordance with the requirements of the plumbing code for storm drainage.~~

SUBSTANTIATION:

Section A 103.1 is being modified to better reflect the applicability of NSF Protocol P151. Since this standard is being referenced, it is imperative that the items requiring compliance are consistent with the scope of the standard.

Section A 103.2 is being updated to remove reference to NSF Protocol P151 as this standard is appropriately addressed in Section A 103.1 for collection surfaces. Section A 103.2 pertains to system drainage materials, not collection/catchment materials, and should therefore be required to comply with the plumbing code for storm drainage. Furthermore, the change in phrasing from "are prohibited" to "shall be prohibited" improves code language.

COMMITTEE ACTION: REJECT

COMMITTEE STATEMENT:

The proposal is being rejected as the Technical Committee disagrees with the use of storm drainage requirements for rainwater catchment system drainage. There is also confusion between material requirements for rainwater catchment systems and rainwater drainage systems. These requirements should be differentiated more clearly.

Also noted was the concern that plumbing systems require a level of freeze protection which may be overly restrictive and impractical for rainwater catchment systems.

TOTAL ELIGIBLE TO VOTE: 30

VOTING RESULTS: AFFIRMATIVE: 28 NOT RETURNED: 2 CRAWFORD, WILLIAMS



CODES ADMINISTRATION

Proposals

Item #: 117

WESStand 2023 Section: A 103.1

SUBMITTER: Laura Allen
Greywater Action

RECOMMENDATION:
Revise text

A 103.0 Potable Rainfall Catchment System Materials.

A 103.1 Collections Surfaces. The collection surface for potable applications shall be constructed of a hard, impervious material ~~and shall be approved for potable water use~~. Roof coatings, paints, and liners shall comply with NSF Protocol P151.

SUBSTANTIATION:

There are no roofing materials approved for potable water use. Therefore, it does not make sense to require something that does not exist.

The study referenced below shows several roofing materials are suitable to use for potable systems. The study recommends using a first flush diverter, filtration, and disinfection, which is consistent with the requirements in this appendix.

Effect of Roof Material on Water Quality for Rainwater Harvesting Systems – Additional Physical, Chemical, and Microbiological Data:

https://www.twdb.texas.gov/innovativewater/rainwater/projects/rainquality/2011_02_rainquality_final_rpt.pdf

COMMITTEE ACTION: REJECT

COMMITTEE STATEMENT:

The language pertaining to collection surfaces needs to be further developed to ensure safe use and approval for intended application. Although there are various materials which are appropriate for potable rainwater collection surfaces, water treatment and material compatibility must be considered together when designing these systems.

TOTAL ELIGIBLE TO VOTE: 30

VOTING RESULTS: AFFIRMATIVE: 28 NOT RETURNED: 2 CRAWFORD, WILLIAMS



CODES ADMINISTRATION

Proposals

Item #: 118

WEStand 2023 Section: A 103.2

SUBMITTER: Laura Allen
Greywater Action

RECOMMENDATION:
Revise text

A 103.0 Potable Rainfall Catchment System Materials.

A 103.2 Rainwater Catchment System Drainage Materials. Gutters and downspouts used in rainwater catchment drainage systems shall be made from seamless nonleaching metal, or plastic pipe that meets the requirements of NSF/ANSI 14 or NSF/ANSI/CAN 61. comply with NSF Protocol P151, and leaders and conductors shall be listed to NSF/ANSI/CAN 61.

Note: NSF/ANSI 14 and NSF/ANSI/CAN 61 meet the requirements for mandatory referenced standards in accordance with Section 15.0 of IAPMO's Regulations Governing Consensus Development of the Water Efficiency and Sanitation Standard.

SUBSTANTIATION:

There are no gutters that comply with NSF Protocol 151. Therefore, it does not make sense to require something that does not exist.

As a reference, the publication titled, "Harvesting, Storing, and Treating Rainwater for Domestic Indoor Use" by the Texas Commission on Environmental Quality states the following:

"We recommend that you install a seamless aluminum gutter or construct your gutter using a plastic pipe that meets the requirements of ANSI/NSF Standard 14 or Standard 61. We do not know of any aluminum gutter that has been certified under either NSF Protocol P151 or ANSI/NSF Standard 61. However, aluminum is a relatively inert material that oxidizes very slowly. Seamless aluminum, therefore, should be relatively safe to use and allows you to avoid joint seams, which can harbor bacteria and algal growths. PVC pipe that meets ANSI/NSF requirements is readily available and will bear an ANSI/NSF label along the length of the pipe. However, PVC gutters will probably not last as long as seamless aluminum gutters, because plastics are more vulnerable to sunlight damage and decay than aluminum."

The above reference document, "Harvesting, Storing, and Treating Rainwater for Domestic Indoor Use," may be accessed via the link below:

http://agrillife.org/rainwaterharvesting/files/2011/05/gi-366_2021994.pdf

NSF Product and Service Listings may be accessed via the link below:

<https://info.nsf.org/Certified/protocols/Listings.asp?TradeName=&Standard=P151>

COMMITTEE ACTION: REJECT

COMMITTEE STATEMENT:

The proposal is being rejected as it may be incomplete regarding the materials used in rainwater catchment drainage systems. The Technical Committee recommends that additional updates be made, and a public comment

be submitted. Additionally, there is concern that NSF/ANSI/CAN 61 does not provide applicable testing requirements.

TOTAL ELIGIBLE TO VOTE: 30

VOTING RESULTS: AFFIRMATIVE: 28 NOT RETURNED: 2 CRAWFORD, WILLIAMS



CODES ADMINISTRATION

Proposals

Item #: 119

WEStand 2023 Section: A 104.2.3, Table A 104.2.1, Table A 104.2.3

SUBMITTER: Laura Allen
Greywater Action

RECOMMENDATION:
Revise text

A 104.0 Design and Installation.

A 104.2 Minimum Water Quality. (remaining text unchanged)

A 104.2.3 Maintenance. Normal system maintenance shall require system testing for total coliform. If a total coliform test is positive, the system shall be tested for Escherichia coli (fecal coliform). Total coliform and turbidity shall be tested every 3 months in accordance with Table A 104.2.3. Upon failure of the fecal coliform test, systems shall be re-commissioned involving cleaning, and retesting in accordance with ~~s~~Section A_104.2.

**TABLE A 104.2.1
MINIMUM WATER QUALITY**

<u>Total Coliform</u>	<u>Non-detectable</u>
Escherichia coli (fecal coliform):	Non-detectable
Turbidity:	<0.3 NTU

**TABLE A 104.2.3
MINIMUM SYSTEM MAINTENANCE REQUIREMENTS**

<u>Total Coliform</u>	<u>Non-detectable</u>
Escherichia coli (fecal coliform):	Non-detectable
Turbidity:	<0.3 NTU

SUBSTANTIATION:

During the last code cycle, Table A 101.5.1 (Minimum Potable Rainwater Catchment System Testing, Inspection and Maintenance Frequency) was updated to require testing for total coliform, which is a more general test when compared to the fecal coliform test, and would better show if the filtration and disinfection system was not operating. If the total coliform test was positive, then a follow-up fecal coliform test would be done. Fecal coliform is a better indicator for a potential pathogen to be found in the system, but is more specific than the total coliform test. So it should be used as a follow up test. Furthermore, starting with a total coliform test is consistent with EPA guidelines for monitoring drinking water.

Under the EPA's Drinking Water Requirements for States and Public Water Systems, the "Revised Total Coliform Rule and Total Coliform Rule" may be accessed via the link below:

<https://www.epa.gov/dwreginfo/revised-total-coliform-rule-and-total-coliform-rule>

COMMITTEE ACTION: ACCEPT AS SUBMITTED

TOTAL ELIGIBLE TO VOTE: 30

VOTING RESULTS: AFFIRMATIVE: 28 NOT RETURNED: 2 CRAWFORD, WILLIAMS



CODES ADMINISTRATION

Proposals

Item #: 120

WEStand 2023 Section: A 104.2.3, Table A 104.2.1, Table A 104.2.3

SUBMITTER: Billy Smith
Chair, WE-Stand Technical Committee

RECOMMENDATION:
Revise text

A 104.0 Design and Installation.

A 104.2 Minimum Water Quality. (remaining text unchanged)

A 104.2.3 Maintenance. Normal system maintenance shall require system testing for Escherichia coli (fecal coliform) and turbidity every 3 months in accordance with Table A 104.2.3. Upon failure of the fecal coliform test, systems shall be re-commissioned involving cleaning, and retesting in accordance with section A_104.2. Testing for viruses and cysts shall occur once after 3 months of initial operation and once every 12 months thereafter.

Exception: Upon failure of the virus or cyst test, testing shall be repeated once every 3 months until results are negative for two consecutive tests.

**TABLE A 104.2.1
MINIMUM WATER QUALITY**

PARAMETER	ACCEPTABLE RANGE
Escherichia coli (fecal coliform):	Non-detectable
<u>Protozoan Cysts</u>	<u>Non-detectable</u>
<u>Viruses</u>	<u>Non-detectable</u>
Turbidity:	<0.3 NTU

**TABLE A 104.2.3
MINIMUM SYSTEM MAINTENANCE REQUIREMENTS**

PARAMETER	ACCEPTABLE RANGE
Escherichia coli (fecal coliform):	Non-detectable
Turbidity:	<0.3 NTU

SUBSTANTIATION:

Section A 104.2.3 is being updated to address testing frequencies for viruses and cysts. The language now requires testing once after three months of initial operation and once per year after that period of time. An exception has also been added to ensure testing is completed on a three month basis in the event of failure. This increased frequency and requirement for two consecutive negative test results is necessary to promote health and safety.

The revisions to Table A 104.2.1 are needed to specify that protozoan cysts and viruses are to be non-detectable in water supplied to a private potable water system. The proposed modifications are also consistent with the plumbing code. Additional revisions have been made to properly label the columns for both Table A 104.2.1 and Table A 104.2.3.

COMMITTEE ACTION: REJECT

COMMITTEE STATEMENT:

The additional parameters within Table A104.2.1 and Table A104.2.3 were reviewed during previous cycles, and it was determined that the inclusion of protozoan cysts and viruses is overly restrictive, costly, and impractical. Such testing is not required at this level unless serving over 100,000 people. For these reasons, the proposal is being rejected.

TOTAL ELIGIBLE TO VOTE: 30

VOTING RESULTS: AFFIRMATIVE: 28 NOT RETURNED: 2 CRAWFORD, WILLIAMS

EXPLANATION OF AFFIRMATIVE:

ALLEN: It is extremely impractical (impossible) to test broadly for unspecified types of viruses and protozoan cysts. And if the standard doesn't specify which to test for it would by default prohibit any potable rainwater system since it's impossible to test for them all. And, as a side note, many are not harmful to humans.

KENDZEL: I am torn on this issue. The type of testing being added, as an example, is not typically asked for private well systems. However, the contamination attempting to be addressed is more related to surface waters. Perhaps we should look at routine verification of disinfection levels of the system.

KOELLER: The word "exception" is not used correctly.

OSANN: This proposal appears to have merit for the protection of public health. One of the most common waterborne pathogens is giardia, a protozoa. The committee contends that testing for viruses and protozoan cysts is expensive and impractical. The proponent should return with a public comment that addresses the testing cost issue. With the current WE•Stand language requiring testing for fecal coliform and turbidity every three months, the addition of a test for protozoan cysts and viruses every 12 months does not appear impractical, so it comes down to cost. Also, the word "Exception" in the proposal is unnecessary.



CODES ADMINISTRATION

Proposals

Item #: 121

WEStand 2023 Section: A 104.3.2

SUBMITTER: Billy Smith
Chair, WE-Stand Technical Committee

RECOMMENDATION:
Revise text

A 104.0 Design and Installation.

A 104.3 Water Quality Devices and Equipment. (remaining text unchanged)

A 104.3.2 Disinfection Devices. Chlorination, ozone, ~~and~~-ultraviolet, or other disinfection methods ~~shall be~~ approved by ~~an~~the Authority Having Jurisdiction, or ~~where~~ the product ~~shall be~~is listed ~~and certified~~ according to a microbiological reduction performance standard for drinking water, ~~shall be~~ used to treat harvested rainwater to meet the required water quality permitted. The disinfection devices and systems shall be installed in accordance with the manufacturer's installation instructions and the conditions of listing. Disinfection devices and systems shall be located downstream of the ~~water~~-storage tank.

SUBSTANTIATION:

The revisions to the above section provide necessary improvements for clarity and enforceability. The proposed modifications are also consistent with the plumbing code.

COMMITTEE ACTION: ACCEPT AS SUBMITTED

TOTAL ELIGIBLE TO VOTE: 30

VOTING RESULTS: AFFIRMATIVE: 17 NEGATIVE: 11 NOT RETURNED: 2 CRAWFORD, WILLIAMS

Note: Item # 121 failed to achieve the necessary two-thirds affirmative vote of returned ballots. In accordance with Section 6.8.2 of the Regulations Governing Consensus Development of the Water Efficiency and Sanitation Standard, a public comment is requested for this proposal. The Technical Committee will reconsider this proposal as a public comment.

EXPLANATION OF NEGATIVE:

BRABAND: Confusing language.

CUDAHY: This doesn't add clarity.

KLEIN: The proposed language is more confusing than the existing language.

KOELLER: Agree with the comments by Mr. Edward Osann and Mr. Pat Lando.

LANDO: The proposed language is more confusing than the existing language.

LENGER: Confusing language not achieving clarification.

OSANN: This proposal leaves the amended paragraph with garbled syntax. The substantiation claims the changes improve clarity and enforceability, but the effect is the opposite. This proposal needs to be corrected in public comment.

PAPE: Agree with all prior comments.

PREMER: This language is confusing.

SOVOCOOL: I agree. It no longer reads properly.

THOMPSON: I agree with the comments submitted by others. The existing text is clearer than the proposed revision.



CODES ADMINISTRATION

Proposals

Item #: 122

WEStand 2023 Section: A 104.5.2.1, A 104.5.2.2

SUBMITTER: Billy Smith
Chair, WE-Stand Technical Committee

RECOMMENDATION:
Revise text

A 104.0 Design and Installation.

A 104.5 Rainwater Storage Tanks. (remaining text unchanged)

A 104.5.2 Location. (remaining text unchanged)

A 104.5.2.1 Above Grade. Above grade storage tanks shall be of an opaque material, approved for aboveground use in direct sunlight, or shall be shielded from direct sunlight. Tanks shall be installed in an accessible location to allow for inspection and cleaning. The tank shall be installed on a foundation or platform that is constructed to accommodate ~~all the weight and~~ loads ~~when filled to maximum capacity~~ in accordance with the building code.

A 104.5.2.2 Below Grade. Rainwater storage tanks installed below grade shall be structurally designed to withstand all anticipated earth or other loads. Holding tank covers shall be capable of supporting an earth load of not less than 300 pounds per square foot (lb/ft²) (1465 kg/m²) when the tank is designed for underground installation. Below grade rainwater tanks installed underground shall be provided with manholes. The manhole opening shall be a minimum diameter of 20 inches (508 mm) and located not less than 4 inches (102 mm) above the surrounding grade. The surrounding grade shall be sloped away from the manhole. Underground tanks shall be ballasted, anchored, or otherwise secured, to prevent the tank from floating out of the ground when empty. The combined weight of the tank and hold down system ~~should~~ **shall** meet or exceed the buoyancy force of the tank.

SUBSTANTIATION:

The proposed text clarifies that foundation and support for rainwater storage tanks must be designed to the maximum weight and associated loads when the tank is filled to capacity. This requirement may be intuitive; however, the new language will ensure such loads are taken into account. The proposed modifications are also consistent with the plumbing code.

COMMITTEE ACTION: ACCEPT AS SUBMITTED

TOTAL ELIGIBLE TO VOTE: 30

VOTING RESULTS: AFFIRMATIVE: 28 NOT RETURNED: 2 CRAWFORD, WILLIAMS



Proposals

Item #: 123

WEStand 2023 Section: Appendix C

SUBMITTER: Jim Kendzel
Chair, WE-Stand Premise Water Supply System Design Task Group

RECOMMENDATION:
Revise text

APPENDIX C PEAK WATER DEMAND CALCULATOR - EXAMPLES

(This Appendix is based on the technical paper entitled "Peak Water Demand Study."
A copy of the paper is available for download at: www.iapmo.org/WEStand/Pages/default.aspx)

C 101.0 General.

C 101.1 Applicability. This appendix provides examples illustrating the use of the Water Demand Calculator to estimate the supply demand load for the building water supply and principal branches and risers for single- and multi-family dwellings. See Chart C 101.1(1) through Chart C 101.1(9) for determining pipe size based on friction loss and maximum allowable pipe velocity.

C 102.8-C 102.0 Examples Illustrating Use of Water Demand Calculator with Appendix A.

C 102.1 Example 1: Indoor Water Use Only. —Use the information given below to find the pipe size for the building supply to a residential building with six indoor fixtures as shown in Figure **C 102.1(1)** [Pipe Section 4].

Given Information:

Type of construction:	Residential, one-bathroom	Friction loss per 100 ft (30 480 mm):	15 psi (103 kPa)
Type of pipe material:	L-copper	Maximum velocity:	10.8 ft/s (2.4 m/s)
Fixture number/type:	1 combination bath/shower 1 lavatory faucet 1 WC	1 kitchen faucet 1 dishwasher 1 clothes washer	

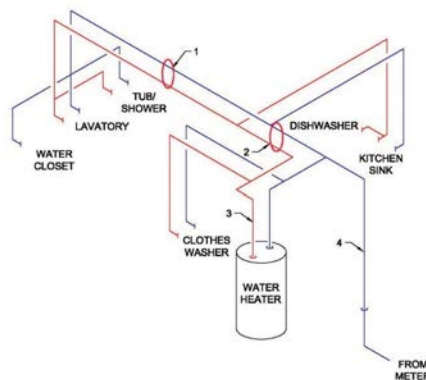

FIGURE **C 102.1(1)**
RESIDENTIAL BUILDING WITH SIX INDOOR FIXTURES

Solution: Step 1 of 2 – Find Demand Load for the Building Supply

The Water Demand Calculator [WDC] in Figure 2-C 102.1(2) is used to determine the demand load expected from indoor water use. The WDC has white-shaded cells and gray-shaded cells. The values in the gray cells are derived from a national survey of indoor water use at homes with efficient fixtures and cannot be changed.

The white-shaded cells accept input from the designer. For instance, fixture counts from the given information are entered in the cColumn [B] designated as total number of fixtures; the corresponding recommended fixture flow rates are already provided in the flow rate cColumn [D]. The flow rates in Column [D] the white cells may be reduced only if the manufacturer specifies a lower flow rate for the fixture. The last cColumn [E] showing maximum fixture flow rates establishes the upper limits for the flow rates entered into the fixture flow rate cColumn [D]. Clicking the “Run Water Demand Calculator/WDC” button gives 8.59.0 gpm (0.57 L/s) as the estimated indoor water demand for the whole building. This result appears in the dark-gray-output box on the right-hand side of the WDC in Figure 2-C 102.1(2).

	[A] FIXTURE	[B] ENTER NUMBER OF FIXTURES	[C] PROBABILITY OF USE (%)	[D] ENTER FIXTURE FLOW RATE (GPM)	[E] MAXIMUM RECOMMENDED FIX- TURE FLOW RATE (GPM)
1	Bar Sink	0	2.0	1.5	1.5
2	Bathub	0	1.0	5.5	5.5
3	Bidet	0	1.0	2.0	2.0
4	Clothes Washer	1	5.5	3.5	3.5
5	Combination Bath/Shower	1	5.5	5.5	5.5
6	Dishwasher	1	0.5	1.3	1.3
7	Kitchen Faucet	1	2.0	2.2	2.2
8	Laundry Faucet	0	2.0	2.0	2.0
9	Lavatory Faucet	1	2.0	1.5	1.5
10	Shower, per head	0	4.5	2.0	2.0
11	Water Closet, 1.28 GPF Gravity Tank	1	1.0	3.0	3.0
12	Other Fixture 1	0	0.0	0.0	6.0
13	Other Fixture 2	0	0.0	0.0	6.0
14	Other Fixture 3	0	0.0	0.0	6.0
Total Number of Fixtures		6			
99th Percentile Demand Flow =		8.5 GPM		RESET	RUN WATER DEMAND CALCULATOR

Water Demand Calculator (WDC v2.1)

PROJECT NAME:
 Click for Drop-down Menu →

Friday, January 21, 2022
11:21 AM

FIXTURE GROUPS	FIXTURE	ENTER TOTAL NUMBER OF FIXTURES	PROBABILITY OF USE (%)	ENTER FIXTURE FLOW RATE (GPM)	MAXIMUM RECOMMENDED FIXTURE FLOW RATE (GPM)
Bathroom Fixtures	1 Bathub (no Shower)	0	1.00	5.5	5.5
	2 Bidet	0	1.00	2.0	2.0
	3 Combination Bath/Shower	1	5.50	5.5	5.5
	4 Faucet, Lavatory	1	2.00	1.5	1.5
	5 Shower, per head (no Bathub)	0	4.50	2.0	2.0
	6 Water Closet, 1.28 GPF Gravity Tank	1	1.00	3.0	3.0
Kitchen Fixtures	7 Dishwasher	1	0.50	1.3	1.3
	8 Faucet, Kitchen Sink	1	2.00	2.2	2.2
Laundry Room Fixtures	9 Clothes Washer	1	5.50	3.5	3.5
	10 Faucet, Laundry	0	2.00	2.0	2.0
Bar/Prep Fixtures	11 Faucet, Bar Sink	0	2.00	1.5	1.5
Other Fixtures	12 Fixture 1	0	0.00	0.0	6.0
	13 Fixture 2	0	0.00	0.0	6.0
	14 Fixture 3	0	0.00	0.0	6.0

COMPUTED RESULTS FOR PEAK PERIOD CONDITIONS

Total No. of Fixtures in Calculation
n = 6

99th Percentile Demand Flow
Q = 9.0 GPM

Hunter Number
H(n,p) = 0.17

Stagnation Probability
Pr[Zero Demand] = 84%

↓ Select Units for Water Demand ↓

FIGURE 2-C 102.1(2)

WATER DEMAND CALCULATOR FOR INDOOR USE AT HOME WITH SIX EFFICIENT FIXTURES (EXAMPLE 1).

Solution: Step 2 of 2 – Determine the Pipe Size of the Building Supply

Chart A 105.1(1) for copper piping systems (from Appendix A of the UPC, shown in Figure 3) Figure C 102.1(3) is used to determine the pipe size, based on given friction loss, given maximum allowable pipe velocity, given pipe material and the demand load computed in Step 1. In Figure 3-C 102.1(3), the intersection of the given friction loss (15 psi) (103 kPa) and the maximum allowable pipe velocity (108 ft/s) (2.4 m/s) is labeled point A. The vertical line that descends from point A to the base of the chart, intersects four nominal sizes for L-copper pipe. These intersection points are labeled B, C, D, E and correspond to pipe sizes of 1 inch (25 mm), ¾ inch (20 mm), ½ inch (15 mm) and 3/8 inch (10 mm), respectively. A horizontal line from points B, C, D, E to the right-hand side of the chart gives maximum flow rates of 2420 gpm (1.3 L/s), 12 gpm (0.75 L/s), 4.5 gpm (0.28 L/s), and 2.3 gpm (0.15 L/s), respectively. These results are

summarized in Table 4-C 102.1 which shows that a 3/4-inch (20 mm) L-copper line is the minimum size that can convey the peak water demand of 8.59.0 gpm (0.57 L/s).

**TABLE 4-C 102.1
PIPE SIZE OPTIONS FOR BUILDING SUPPLY**

POINT IN FIGURE 3 C 102.1(3)	PIPE DIAMETER (inch)	MAXIMUM FLOW (gpm)	OK FOR BUILDING SUPPLY ^{4*}
E	3/8	2.3	No
D	1/2	4.5	No
C	3/4	12	Yes
B	1	24.20	Yes

For SI units: 1 inch = 25 mm, 1 gallon per minute = 0.06 L/s

^{4*}For Building in Examples 1, 2, 3, and 4.

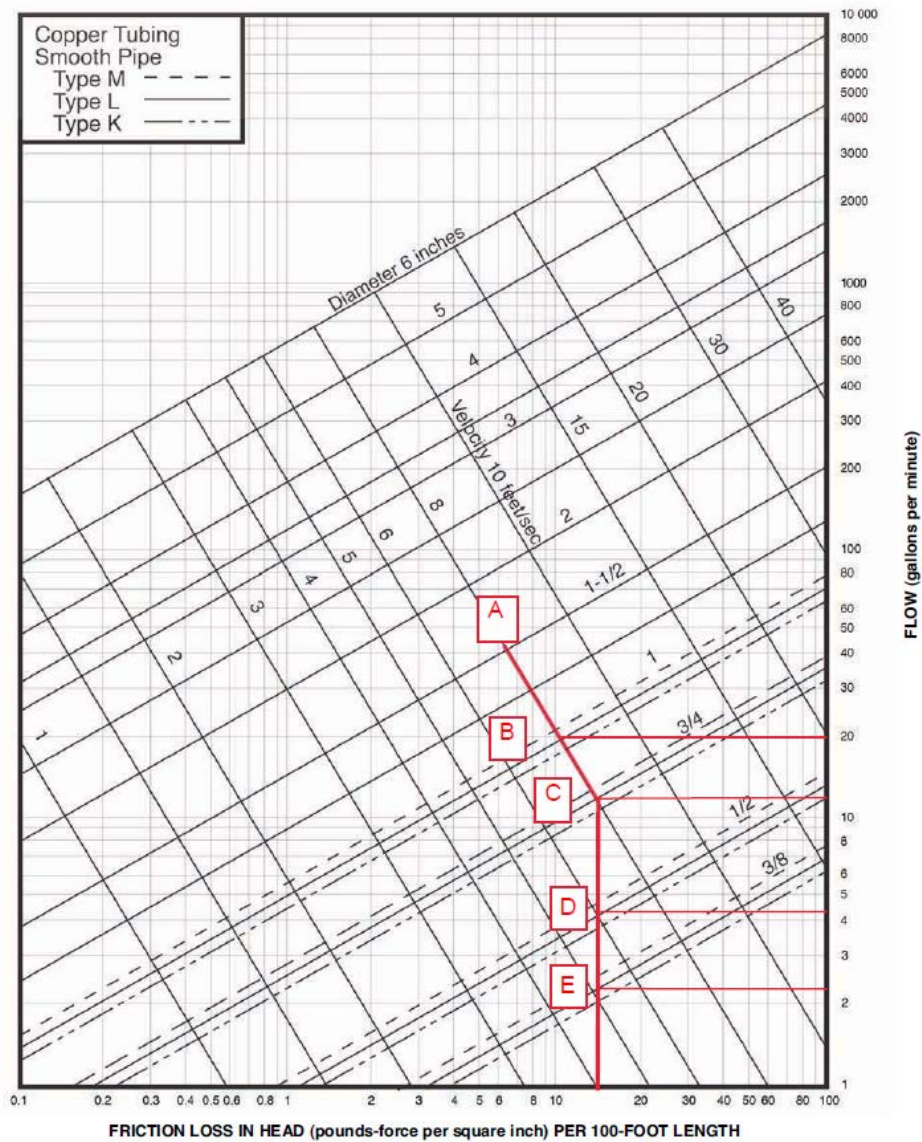

**FIGURE 3-C 102.1(3)
CHART A-105.4(4)-C 101.1(1) FOR FINDING PIPE SIZE**

For SI units: 1 inch = 25 mm, 1 gallon per minute = 0.06 L/s, 1 pound-force per square inch = 6.8947 kPa, 1 foot = 304.8 mm, 1 foot per second = 0.3048 m/s

C 102.2 Example 2: Indoor and Outdoor Water Use. – Find the pipe size for the building supply [Figure 4C 102.1(1), Pipe Section 4] if the building in Example 1 adds two outdoor fixtures [(hose bibbs, each with a fixture flow of 2.0 gpm (0.13 L/s)].

Solution: Step 1 of 2 – Find Demand Load for the Building Supply

The WDC has been developed exclusively for peak indoor water use which can be viewed as a high frequency short duration process. Because fixtures for outdoor water use may operate continuously for very long periods, they are not included in the WDC. To account for water use from one or more outdoor fixtures, add the demand of the single outdoor fixture with the highest flowrate to the calculated demand for indoor water use. With two hose bibbs, the demand of only one hose bibb is included. Hence, in this example, the total demand for the whole house is ~~8.5~~ **9.0 gpm (0.57 L/s)** + 2.0 gpm (0.13 L/s) = ~~10.5~~ **11.0 gpm (0.70 L/s)**.

Solution: Step 2 of 2 – Determine the Pipe Size of the Building Supply

Table 4C 102.1 shows that at ~~10.5~~ **11.0 gpm (0.70 L/s)** the building supply shall be ¾-inch in diameter.

C 102.3 Example 3: Indoor, Outdoor and Other Fixture Water Use. – Find the pipe size for the water supply [Figure 4C 102.1(1), Pipe Section 4] if the building in Example 2 adds a kitchen pot filler and a dog bath each with a faucet flow rate of 5.5 gpm (0.35 L/s).

Solution: Step 1 of 2 – Find Demand Load for the Building Supply

The kitchen pot filler and dog bath are not listed in the fixture list cColumn [A] of the WDC. To accommodate cases such as this, the WDC provides up to three additional rows for “Other Fixtures.” Enter the kitchen pot filler and dog bath in the fixture list cColumn [A] of the WDC and enter the fixture count for each in the next cColumn [B]. Find an indoor fixture that has a similar probability of use in the probability cColumn [C] and add that to the column. Finally, enter the flow rate of the kitchen pot filler and dog bath in in the flow rate cColumn [D]. The estimated indoor water demand for the whole building is **11.0 gpm (0.70 L/s)**, as shown in the WDC in Figure 4-C 102.3. As illustrated in Example 2, the hose bibb will increase the total demand for the whole house to **13.0 gpm (0.82 L/s)**.

~~Note that a reset button is provided to clear any numbers in Column [B] from a previous calculation.~~

Solution: Step 2 of 2 – Determine the Pipe Size of the Building Supply

Table 4C 102.1 shows that at **13.0 gpm (0.82 L/s)** the building supply shall be 1-inch (25 mm) in diameter.

	[A] FIXTURE	[B] ENTER NUMBER OF FIXTURES	[C] PROBABILITY OF USE (%)	[D] ENTER FIXTURE FLOW RATE (GPM)	[E] MAXIMUM RECOMMENDED FIX- TURE FLOW RATE (GPM)
1	Bar Sink	0	2.0	1.5	1.5
2	Bathtub	0	1.0	5.5	5.5
3	Bidet	0	1.0	2.0	2.0
4	Clothes Washer	1	5.5	3.5	3.5
5	Combination Bath/Shower	1	5.5	5.5	5.5
6	Dishwasher	1	0.5	1.3	1.3
7	Kitchen Faucet	1	2.0	2.2	2.2
8	Laundry Faucet	0	2.0	2.0	2.0
9	Lavatory Faucet	1	2.0	1.5	1.5
10	Shower, per head	0	4.5	2.0	2.0
11	Water Closet, 1.28 GPF Gravity Tank	1	1.0	3.0	3.0
12	Kitchen Pot Filler	1	2.0	5.5	6.0
13	Dog Bath	1	1.0	5.5	6.0
14	Other Fixture 3	0	0.0	0.0	6.0
Total Number of Fixtures		8		RESET	RUN WATER DEMAND CALCULATOR
99th Percentile Demand Flow =		11.0 GPM			

Water Demand Calculator (WDC v2.1)

PROJECT NAME:
 Click for Drop-down Menu →

Friday, January 21, 2022
12:09 PM

FIXTURE GROUPS	FIXTURE	ENTER TOTAL NUMBER OF FIXTURES	PROBABILITY OF USE (%)	ENTER FIXTURE FLOW RATE (GPM)	MAXIMUM RECOMMENDED FIXTURE FLOW RATE (GPM)
Bathroom Fixtures	1 Bathtub (no Shower)	0	1.00	5.5	5.5
	2 Bidet	0	1.00	2.0	2.0
	3 Combination Bath/Shower	1	5.50	5.5	5.5
	4 Faucet, Lavatory	1	2.00	1.5	1.5
	5 Shower, per head (no Bathtub)	0	4.50	2.0	2.0
	6 Water Closet, 1.28 GPF Gravity Tank	1	1.00	3.0	3.0
Kitchen Fixtures	7 Dishwasher	1	0.50	1.3	1.3
	8 Faucet, Kitchen Sink	1	2.00	2.2	2.2
Laundry Room Fixtures	9 Clothes Washer	1	5.50	3.5	3.5
	10 Faucet, Laundry	0	2.00	2.0	2.0
Bar/Prep Fixtures	11 Faucet, Bar Sink	0	2.00	1.5	1.5
	12 Kitchen Pot Filler	1	2.00	5.5	6.0
Other Fixtures	13 Dog Bath	1	1.00	5.5	6.0
	14 Fixture 3	0	0.00	0.0	6.0

COMPUTED RESULTS FOR PEAK PERIOD CONDITIONS

Total No. of Fixtures in Calculation
n = 8

99th Percentile Demand Flow
Q = 11.0 GPM

Hunter Number
H(n,p) = 0.20

Stagnation Probability
Pr[Zero Demand] = 82%

↓ Select Units for Water Demand ↓

FIGURE 4-C 102.3
WATER DEMAND CALCULATOR TO ACCOMMODATE OTHER FIXTURES (EXAMPLE 3).

C 102.4 Example 4: Sizing Branches and Risers. For individual hot and cold branches, repeat Steps 1 and 2. For example, for the hot water branch at the water heater [Figure 4-C 102.1(1), Pipe Section 3], enter all the fixtures and appliances that use hot water into the Water Demand Calculator (toilets will be excluded) as seen in Figure 5-C 102.4. Use the calculated demand load to find the pipe size in Step 2. Table 4-C 102.1 shows that at 7.79.0 gpm (0.57 L/s), the hot water branch shall be ¾-inch (20 mm) in diameter.

For each additional hot and cold branch [Figure 4-C 102.1(1), Pipe Sections 1 and 2], enter the number of fixtures and appliances served by that branch into the WDC and use that demand in Step 2 to determine the branch size. If the branch serves a hose bibb, add the demand of the hose bibb to the calculated demand flow for the branch. As discussed in Example 2, the hose bibb is not to be entered into WDC, since the Calculator is for indoor uses only. When there is only one fixture or appliance served by a fixture branch, the demand flow shall not exceed the fixture flow rate in the last column [E] of the Water Demand Calculator. The fixture flow rate would be used in Step 2 to determine the size of the fixture branch and supply.

	[A] FIXTURE	[B] ENTER NUMBER OF FIXTURES	[C] PROBABILITY OF USE (%)	[D] ENTER FIXTURE FLOW RATE (GPM)	[E] MAXIMUM RECOMMENDED FIX- TURE FLOW RATE (GPM)
1	Bar Sink	0	2.0	1.5	1.5
2	Bathtub	0	1.0	5.5	5.5
3	Bidet	0	1.0	2.0	2.0
4	Clothes Washer	1	5.5	3.5	3.5
5	Combination Bath/Shower	1	5.5	5.5	5.5
6	Dishwasher	1	0.5	1.3	1.3
7	Kitchen Faucet	1	2.0	2.2	2.2
8	Laundry Faucet	0	2.0	2.0	2.0
9	Lavatory Faucet	1	2.0	1.5	1.5
10	Shower, per head	0	4.5	2.0	2.0
11	Water Closet, 1.28 GPF Gravity Tank	0	1.0	3.0	3.0
12	Other Fixture 1	0	0.0	0.0	6.0
13	Other Fixture 2	0	0.0	0.0	6.0
14	Other Fixture 3	0	0.0	0.0	6.0
Total Number of Fixtures		5			
99th Percentile Demand Flow =		7.7 GPM			
				RESET	RUN WATER DEMAND CALCULATOR

Water Demand Calculator (WDC v2.1)

PROJECT NAME : Friday, January 21, 2022
12:19 PM

Click for Drop-down Menu → COMPUTED RESULTS FOR PEAK PERIOD CONDITIONS

FIXTURE GROUPS	FIXTURE	ENTER TOTAL NUMBER OF FIXTURES	PROBABILITY OF USE (%)	ENTER FIXTURE FLOW RATE (GPM)	MAXIMUM RECOMMENDED FIXTURE FLOW RATE (GPM)
Bathroom Fixtures	1 Bathtub (no Shower)	0	1.00	5.5	5.5
	2 Bidet	0	1.00	2.0	2.0
	3 Combination Bath/Shower	1	5.50	5.5	5.5
	4 Faucet, Lavatory	1	2.00	1.5	1.5
	5 Shower, per head (no Bathtub)	0	4.50	2.0	2.0
	6 Water Closet, 1.28 GPF Gravity Tank	0	1.00	3.0	3.0
Kitchen Fixtures	7 Dishwasher	1	0.50	1.3	1.3
	8 Faucet, Kitchen Sink	1	2.00	2.2	2.2
Laundry Room Fixtures	9 Clothes Washer	1	5.50	3.5	3.5
	10 Faucet, Laundry	0	2.00	2.0	2.0
Bar/Prep Fixtures	11 Faucet, Bar Sink	0	2.00	1.5	1.5
	12 Fixture 1	0	0.00	0.0	6.0
Other Fixtures	13 Fixture 2	0	0.00	0.0	6.0
	14 Fixture 3	0	0.00	0.0	6.0

Total No. of Fixtures in Calculation
n = 5

99th Percentile Demand Flow
Q = 9.0 GPM

Hunter Number
H(n,p) = 0.16

Stagnation Probability
Pr[Zero Demand] = 85%

↓ Select Units for Water Demand ↓

FIGURE 5-C 102.4
WATER DEMAND CALCULATOR FOR THE HOT WATER BRANCH (EXAMPLE 4).

C 102.5 Example 5: Multi-family Application. When using the WDC for multi-family dwellings, use the drop-down menu on the top left corner that allows you to select either single-family residence or a multi-family building. Choosing the multi-family option opens two more boxes to fill in information. (See Figure C 102.5.) When estimating for a multi-family building, enter the total number of dwelling units in the building. The example shows a total of 100 dwelling units in the building. The box below it will be for the number of units you are calculating for. If you are calculating for the whole building, enter the same number of 100. If you are calculating for half the dwelling units, enter 50. If you are estimating for only one unit, then enter the number one. The total number of units in the first box will not change in any of your calculations. Then use the WDC, as has been explained earlier, for sizing branches and risers.

Water Demand Calculator (WDC v2.1)

PROJECT NAME : Friday, February 4, 2022
4:37 PM

Click for Drop-down Menu → COMPUTED RESULTS FOR PEAK PERIOD CONDITIONS

Total Number of Apartments in the Building →
Total Apartments in this Calculation →

FIXTURE GROUPS	FIXTURE	ENTER TOTAL NUMBER OF FIXTURES	PROBABILITY OF USE (%)	ENTER FIXTURE FLOW RATE (GPM)	MAXIMUM RECOMMENDED FIXTURE FLOW RATE (GPM)
Bathroom Fixtures	1 Bathtub (no Shower)	0	0.45	5.5	5.5
	2 Bidet	0	0.57	2.0	2.0
	3 Combination Bath/Shower	0	1.69	5.5	5.5
	4 Faucet, Lavatory	0	1.22	1.5	1.5
	5 Shower, per head (no Bathtub)	0	1.14	2.0	2.0
	6 Water Closet, 1.28 GPF Gravity Tank	0	0.57	3.0	3.0
Kitchen Fixtures	7 Dishwasher	0	0.34	1.3	1.3
	8 Faucet, Kitchen Sink	0	1.22	2.2	2.2
Laundry Room Fixtures	9 Clothes Washer	0	1.62	3.5	3.5
	10 Faucet, Laundry	0	1.22	2.0	2.0
Bar/Prep Fixtures	11 Faucet, Bar Sink	0	1.22	1.5	1.5
	12 Fixture 1	0	0.00	0.0	6.0
Other Fixtures	13 Fixture 2	0	0.00	0.0	6.0
	14 Fixture 3	0	0.00	0.0	6.0

Total No. of Fixtures in Calculation

99th Percentile Demand Flow

Hunter Number

Stagnation Probability

↓ Select Units for Water Demand ↓

FIGURE C 102.5
WATER DEMAND CALCULATOR FOR MULTI-FAMILY DWELLINGS (EXAMPLE 5).

CHART C 101.1(1)

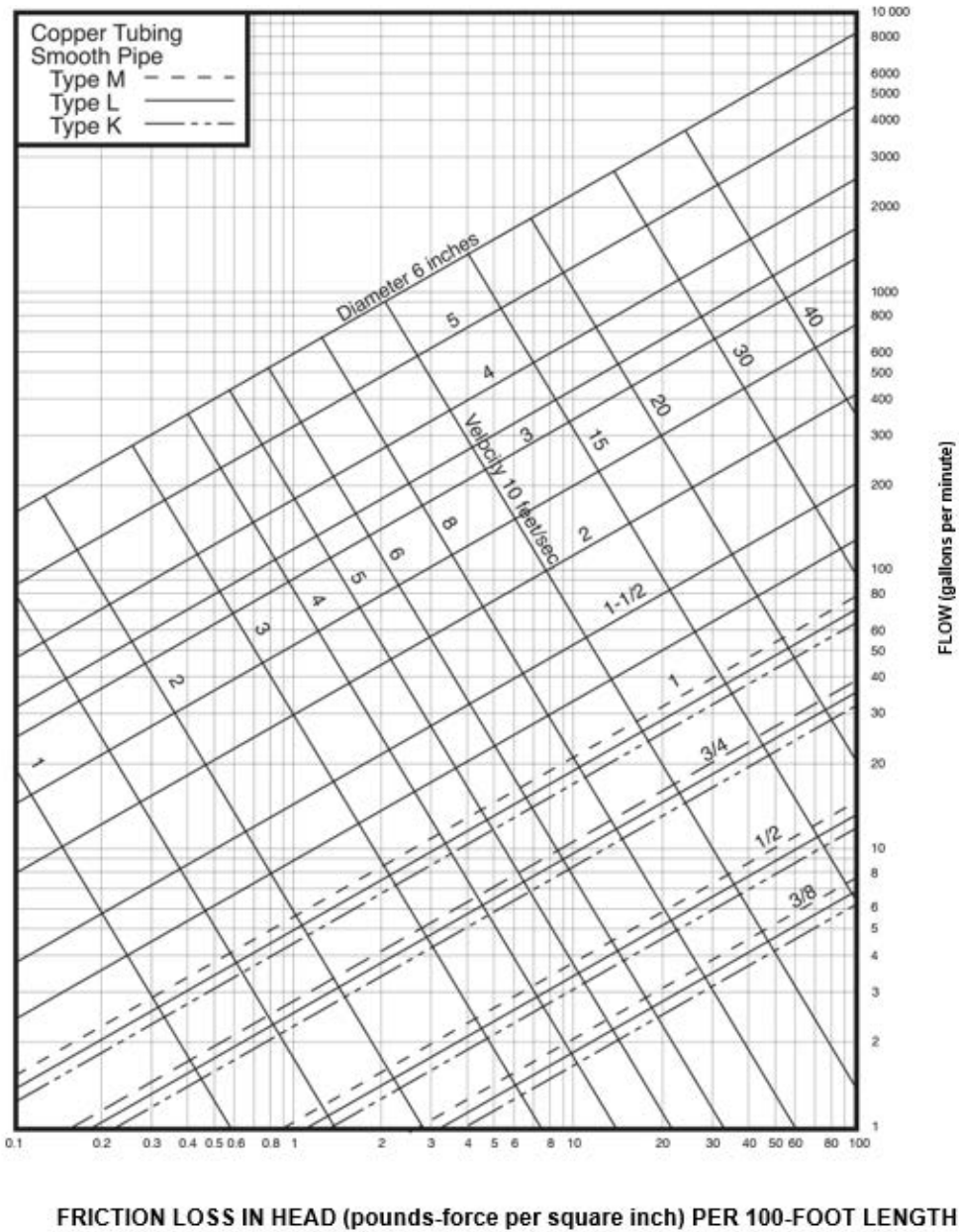

For SI units: 1 inch = 25 mm, 1 gallon per minute = 0.06 L/s, 1 pound-force per square inch = 6.8947 kPa, 1 foot = 304.8 mm, 1 foot per second = 0.3048 m/s

CHART C 101.1(2)

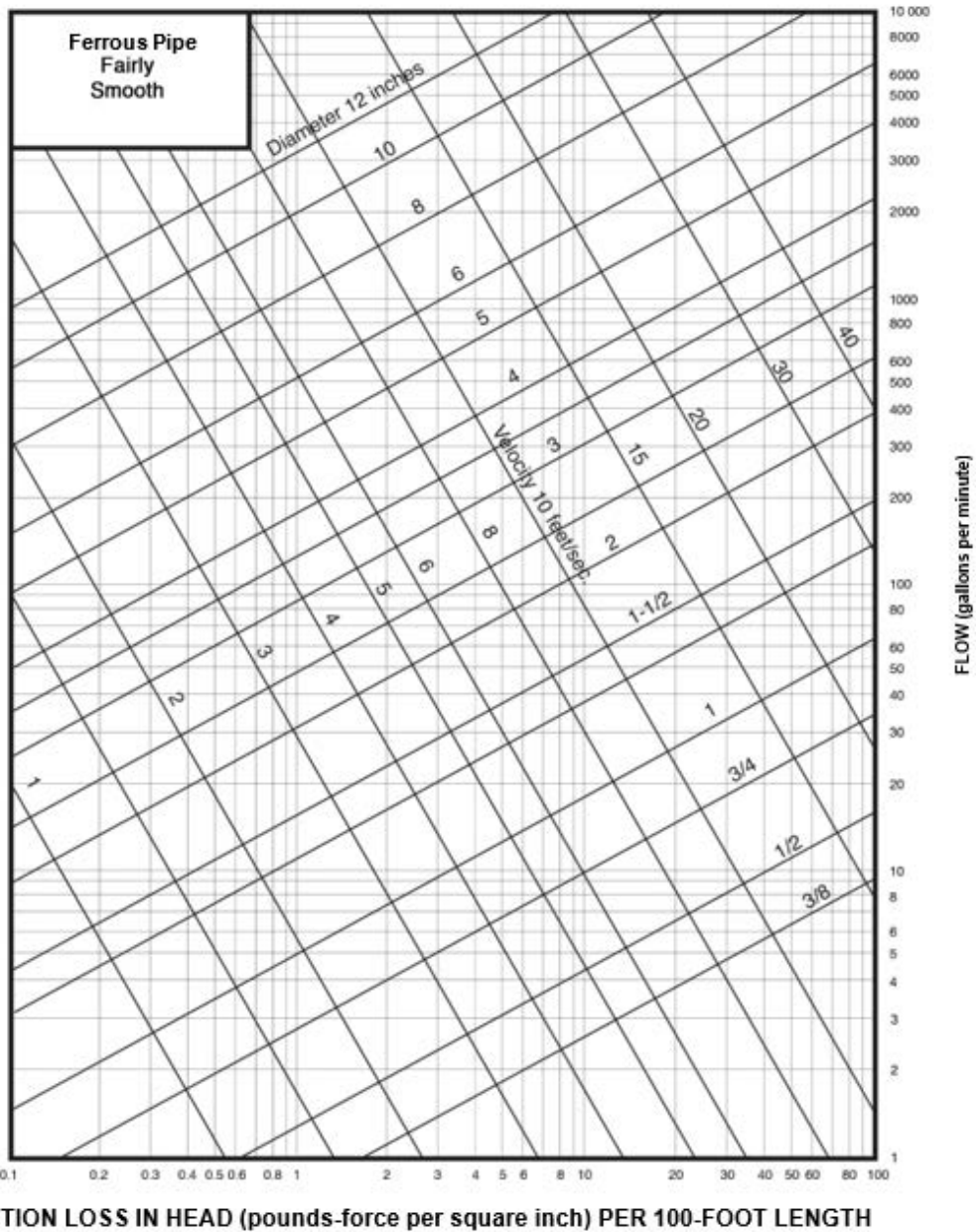

For SI units: 1 inch = 25 mm, 1 gallon per minute = 0.06 L/s, 1 pound-force per square inch = 6.8947 kPa, 1 foot = 304.8 mm, 1 foot per second = 0.3048 m/s

CHART C 101.1(3)

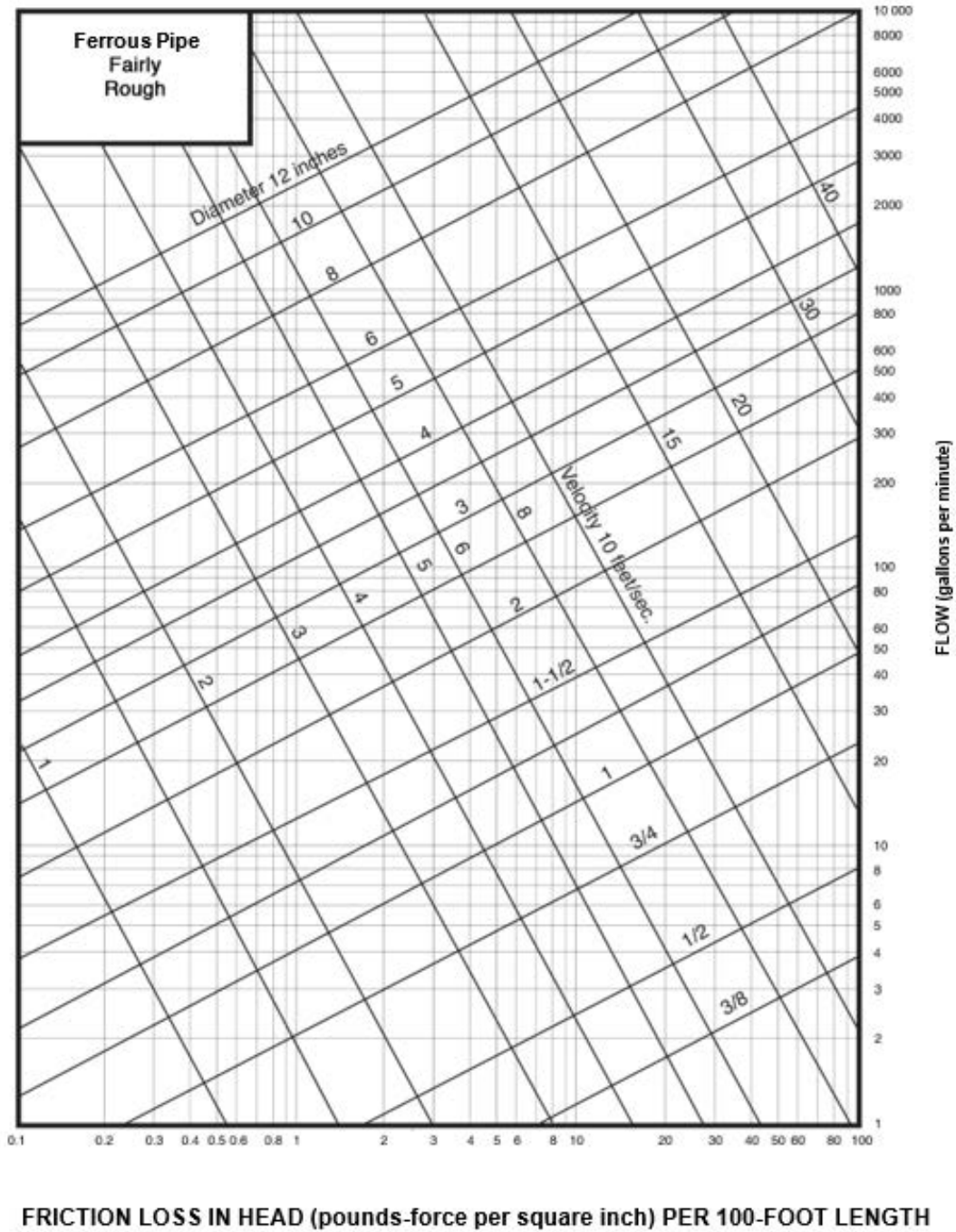

For SI units: 1 inch = 25 mm, 1 gallon per minute = 0.06 L/s, 1 pound-force per square inch = 6.8947 kPa, 1 foot = 304.8 mm, 1 foot per second = 0.3048 m/s

CHART C 101.1(4)

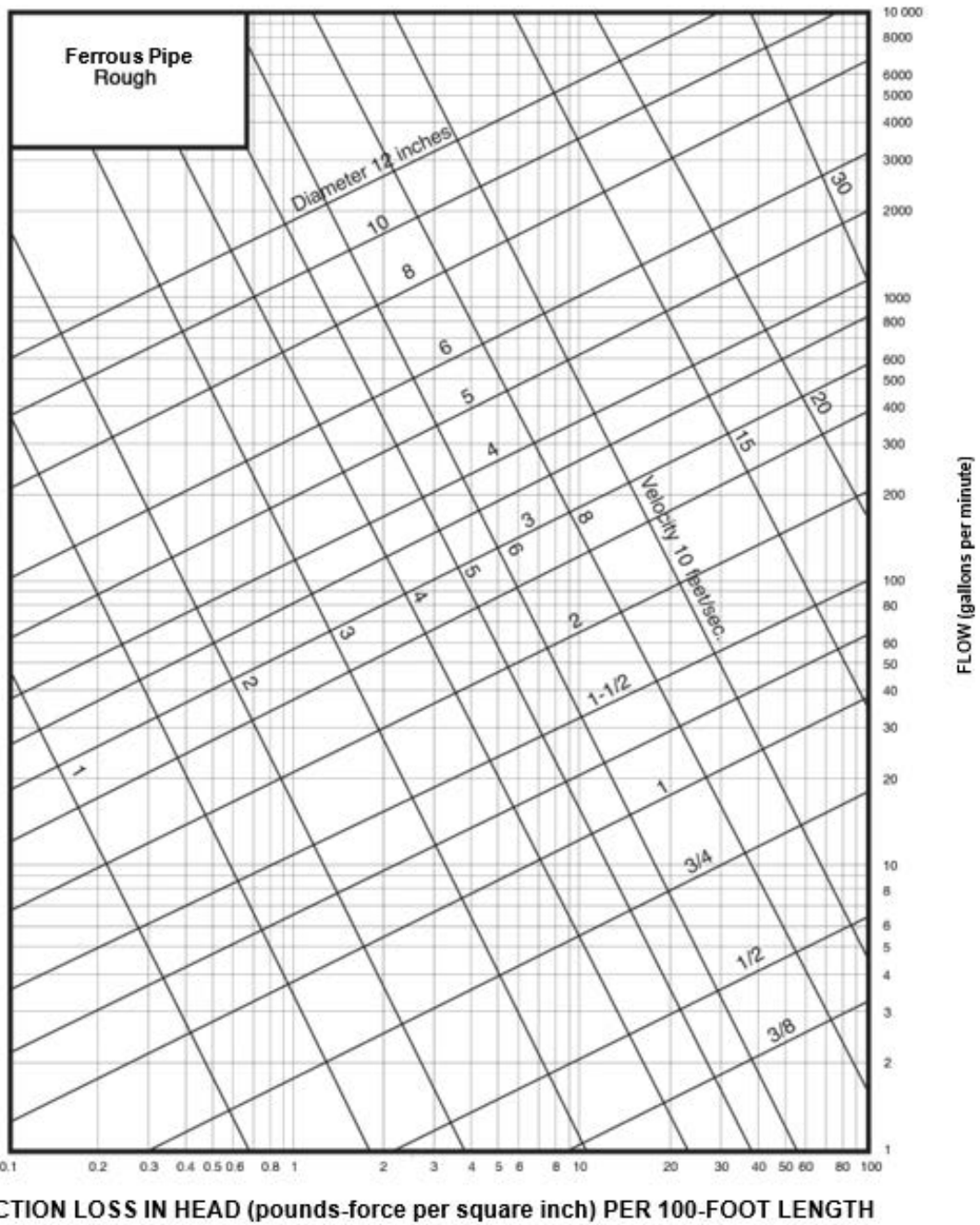

For SI units: 1 inch = 25 mm, 1 gallon per minute = 0.06 L/s, 1 pound-force per square inch = 6.8947 kPa, 1 foot = 304.8 mm, 1 foot per second = 0.3048 m/s

CHART C 101.1(5)

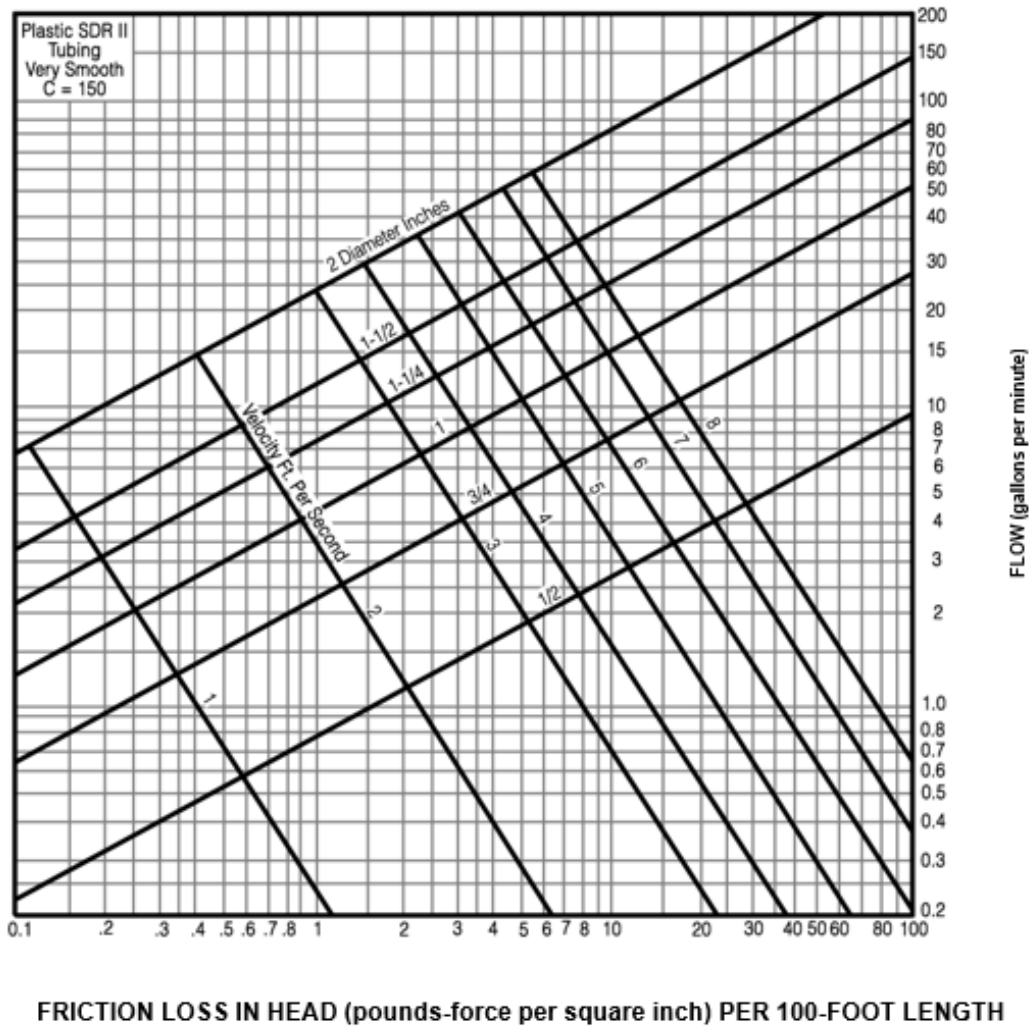

For SI units: 1 inch = 25 mm, 1 gallon per minute = 0.06 L/s, 1 pound-force per square inch = 6.8947 kPa, 1 foot = 304.8 mm, 1 foot per second = 0.3048 m/s

CHART C 101.1(6)

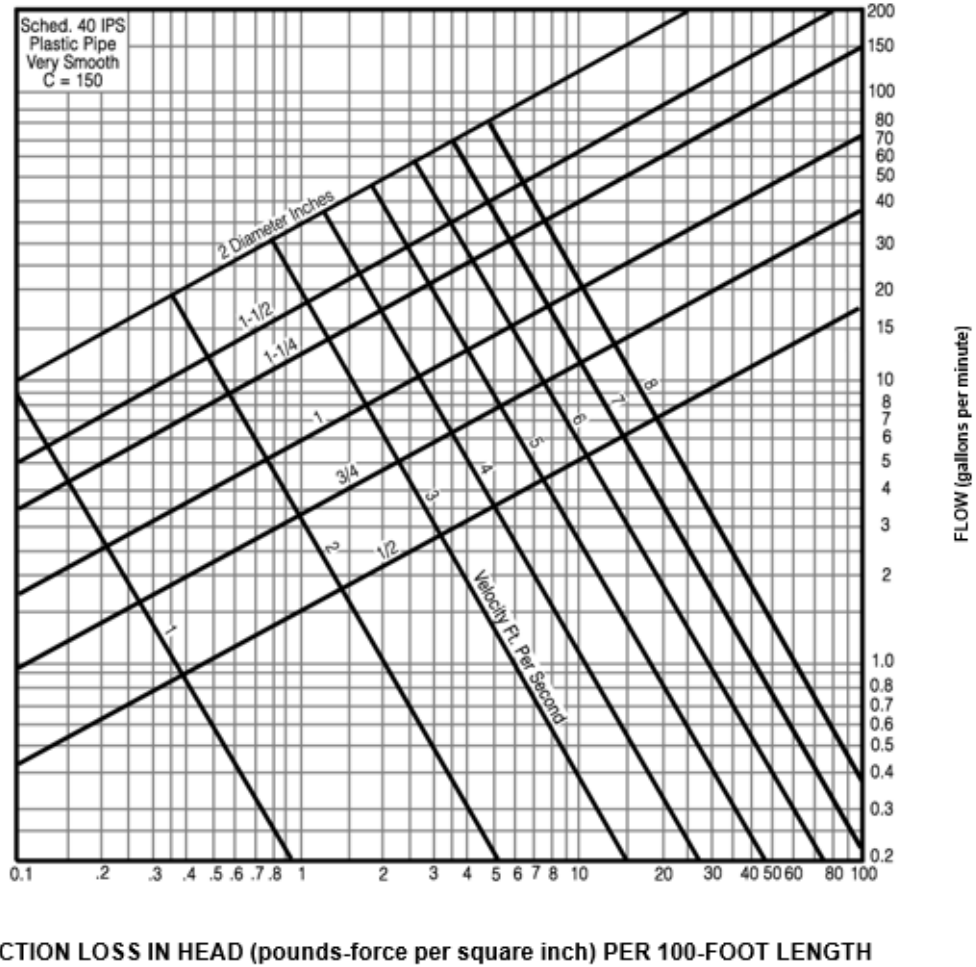

For SI units: 1 inch = 25 mm, 1 gallon per minute = 0.06 L/s, 1 pound-force per square inch = 6.8947 kPa, 1 foot = 304.8 mm, 1 foot per second = 0.3048 m/s

CHART C 101.1(7)

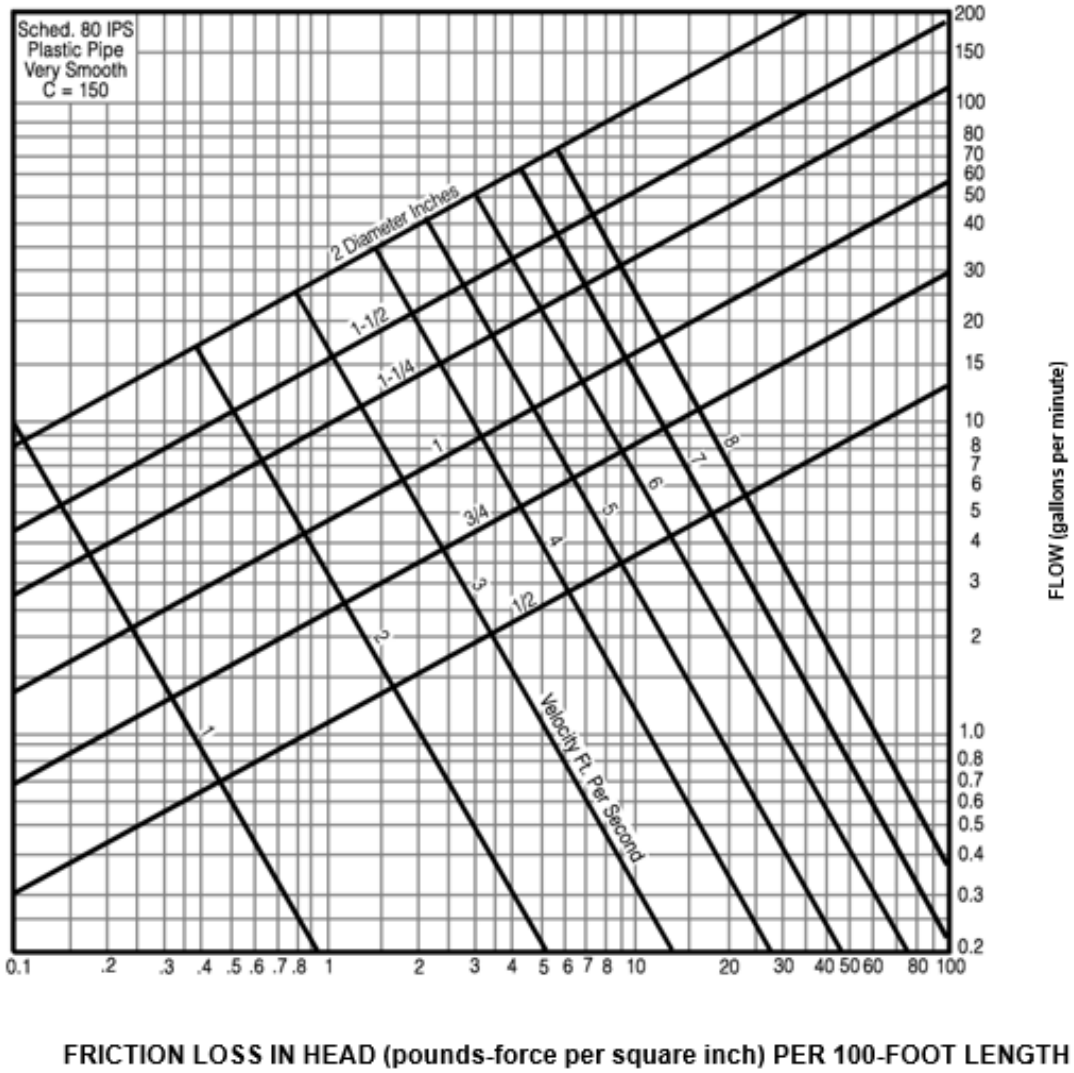

For SI units: 1 inch = 25 mm, 1 gallon per minute = 0.06 L/s, 1 pound-force per square inch = 6.8947 kPa, 1 foot = 304.8 mm, 1 foot per second = 0.3048 m/s

CHART C 101.1(8)
PRESSURE LOSS OF PEX TUBING AT 60°F

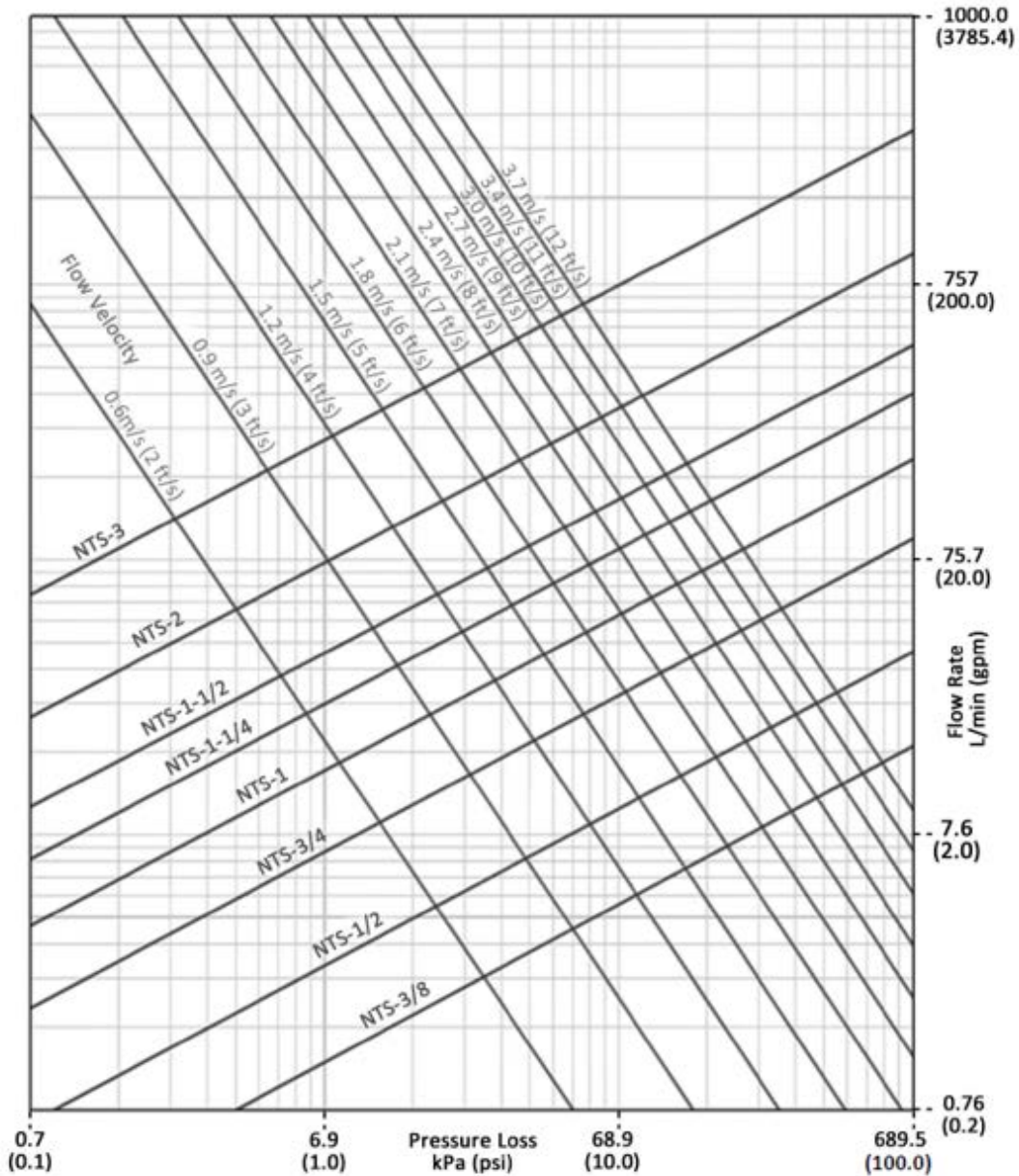

For SI units: °C = (°F-32)/1.8, 1 inch = 25 mm, 1 gallon per minute = 0.06 L/s, 1 pound-force per square inch = 6.8947 kPa, 1 foot = 304.8 mm, 1 foot per second = 0.3048 m/s

CHART C 101.1(9)
PRESSURE LOSS OF PEX TUBING AT 120°F

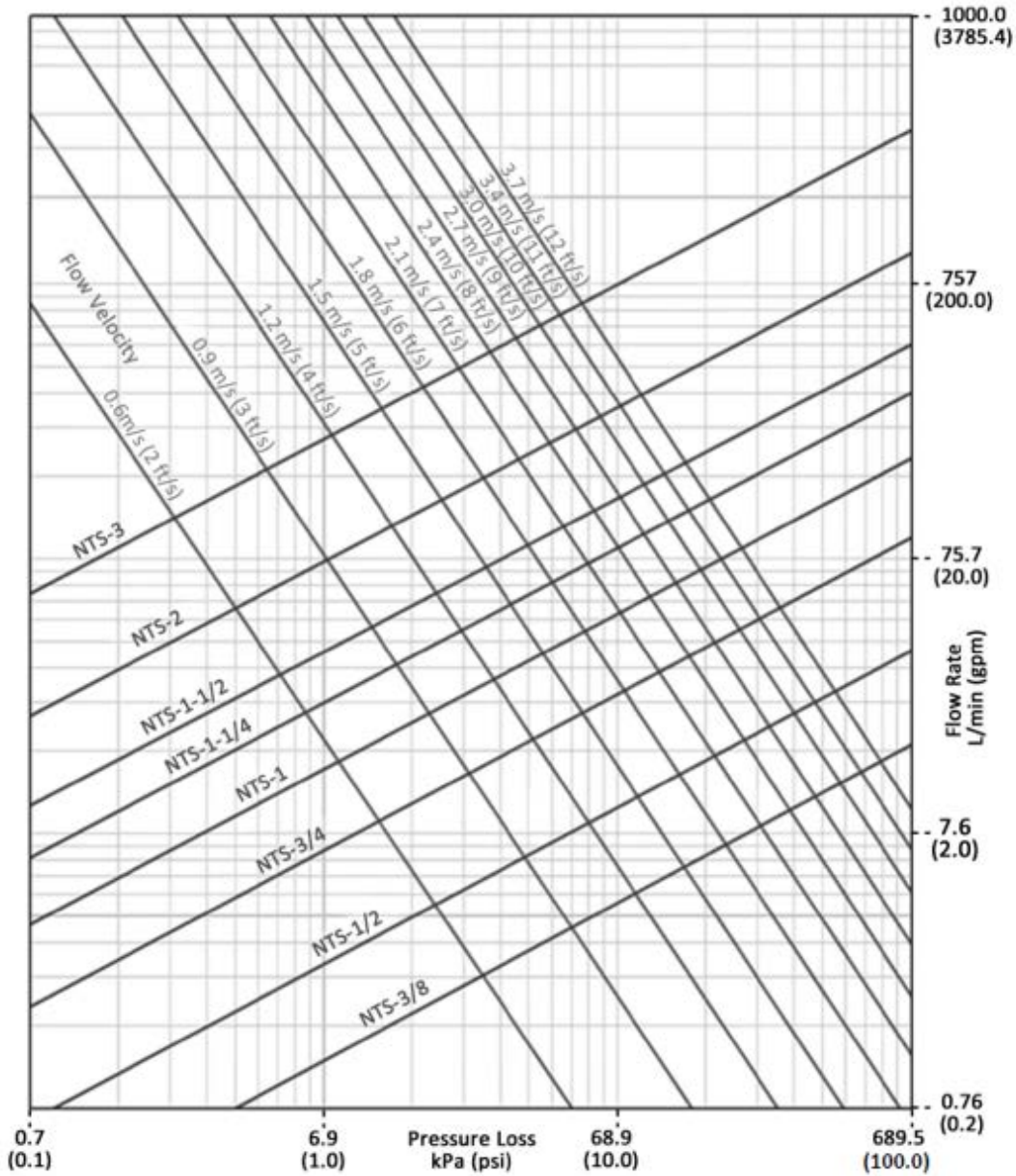

For SI units: °C = (°F-32)/1.8, 1 inch = 25 mm, 1 gallon per minute = 0.06 L/s, 1 pound-force per square inch = 6.8947 kPa, 1 foot = 304.8 mm, 1 foot per second = 0.3048 m/s

SUBSTANTIATION:

In support of the other recommendations generated by this Task Group, Appendix C has been revised to include updated examples for the Water Demand Calculator. As depicted within the applicability, the provided examples illustrate the use of the WDC to estimate the supply demand load for the building water supply and principal branches and risers for single- and multi-family dwellings.

To provide users of this appendix with figures that more closely resemble the WDC program, the previous tables used for data inputs were replaced with screen captures of the WDC software. This also allowed for the removal of references to specific columns throughout the text. Additionally, the values provided were revised for consistency with the updated examples as shown in the WDC program figures.

Previously, this appendix did not offer an example of a multi-family application, nor did it include the necessary charts for determining pipe size based on friction loss and maximum allowable pipe velocity. Appendix C can now be used without cross-reference to another standard or to the plumbing code.

Chart C 101.1(1) through Chart C 101.1(7) were gathered from Appendix A (Recommended Rules for Sizing the Water Supply System) of the UPC, and Chart C 101.1(8) and Chart C 101.1(9) were gathered from IAPMO IS 31 (Installation Standard for PEX Tubing Systems for Hot- and Cold-Water Distribution).

In summary, the updates made to Appendix C are necessary to provide users of the WE-Stand with the appropriate tools for correctly using the Water Demand Calculator.

Additional information on the Water Demand Calculator may be found via the following link:
<https://www.iapmo.org/water-demand-calculator/>

[Supporting documentation is provided in KAVI for TC review]

COMMITTEE ACTION: REJECT

COMMITTEE STATEMENT:

Based on the actions taken on Item #074, Item #123 is also being rejected. Chart C101.1(1) through Chart C101.1(9) from this proposal should be relocated to Chapter 5. This relocation would prevent conflict where Appendix C is not adopted by the jurisdiction and ensure applicable tools are provided for utilizing the WDC. The Technical Committee has identified this as the only reason for rejection and requests this change be made via public comment.

TOTAL ELIGIBLE TO VOTE: 30

VOTING RESULTS: AFFIRMATIVE: 24 NEGATIVE: 4 NOT RETURNED: 2 CRAWFORD, WILLIAMS

EXPLANATION OF NEGATIVE:

KLEIN: This needs to be cleaned up during public comment.

KOELLER: Rejection of this entire proposal because of one minor item of figure placement ("has identified this as the only reason for rejection") is unwarranted, when recommended modifications could have readily been made by the Technical Committee when originally considered.

LANDO: I agree with John Koeller. This needs to be cleaned up during public comment.

PAPE: Agree with John Koeller.



CODES ADMINISTRATION

Proposals

Item #: 124

WEStand 2023 Section: Appendix E, E 101.0 - E 101.6

SUBMITTER: Markus Lenger
Chair, WE-Stand Direct Potable Water Reuse Task Group

RECOMMENDATION:
Add new text

APPENDIX E **ONSITE WASTEWATER TREATMENT FOR DIRECT POTABLE WATER REUSE**

E 101.0 General.

E 101.1 Applicability. The provisions of this appendix shall apply to the design and installation of onsite wastewater treatment systems for direct potable water reuse in one- and two-unit residential buildings.

E 101.2 Permit. It shall be unlawful for any person to construct, install, alter, or cause to be constructed, installed, or altered any onsite wastewater treatment system within a building or on a premises without first obtaining a permit to do such work from the Authority Having Jurisdiction.

E 101.2.1 Plumbing Plan Submission. No permit for any onsite wastewater treatment system shall be issued until complete plumbing plans, with appropriate data satisfactory to the Authority Having Jurisdiction, have been submitted and approved.

E 101.2.2 System Changes. No changes or connections shall be made to the onsite wastewater treatment system without approval by the Authority Having Jurisdiction.

E 101.3 Component Identification. System components shall be properly identified as to the manufacturer.

E 101.4 Maintenance and Inspection. Mechanical and plumbing systems, materials, and appurtenances, both existing and new, of a premise under the Authority Having Jurisdiction, shall be maintained in operating conditions. Devices or safeguards required by this appendix shall be maintained in accordance with the standard edition under which installed. The owner or the owner's designated agent shall be responsible for the maintenance of mechanical and plumbing systems. To determine compliance with this subsection, the Authority Having Jurisdiction shall be permitted to cause a system to be reinspected.

E 101.5 Material Compatibility. Onsite wastewater treatment systems shall be constructed of materials that are compatible with the type of pipe and fitting materials, water treatment, and water conditions in the system.

E 101.6 Minimum Water Quality Requirements. The minimum output water quality of an onsite wastewater treatment system shall meet the potable water quality requirements of the adopted direct potable water reuse standards, or in absence, shall comply with the water quality requirements specified by the Authority Having Jurisdiction.

SUBSTANTIATION:

The proposed Appendix E addresses design and installation of onsite wastewater treatment systems for direct potable water reuse in one- and two-unit residential buildings. Currently the WE•Stand does not address these types of onsite treatment systems, and such inclusion would be beneficial. There is an increasing demand for water treatment and reuse systems in residential applications, and the proposed language offers an innovative approach which is effective at reducing water consumption.

As there are varying potable water requirements per local jurisdiction, the minimum required water quality for the output of these treatment systems is required to comply with the AHJ. Basic provisions for maintenance and inspection have also been included to ensure systems are maintained in safe operating conditions.

COMMITTEE ACTION: ACCEPT AS AMENDED BY THE TC

APPENDIX E
ONSITE WASTEWATER TREATMENT FOR DIRECT POTABLE WATER REUSE

E 101.0 General.

E 101.1 Applicability. The provisions of this appendix shall apply to the design and installation of onsite wastewater treatment systems for direct potable water reuse in one- and two-unit ~~residential buildings~~ family dwellings and townhouses.

E 101.2 Permit. It shall be unlawful for any person to construct, install, alter, or cause to be constructed, installed, or altered any onsite wastewater treatment system within a building or on a premises without first obtaining a permit to do such work from the Authority Having Jurisdiction.

E 101.2.1 Plumbing Plan Submission. No permit for any onsite wastewater treatment system shall be issued until complete plumbing plans, with appropriate data satisfactory to the Authority Having Jurisdiction, have been submitted and approved.

E 101.2.2 System Changes. No changes or connections shall be made to the onsite wastewater treatment system without approval by the Authority Having Jurisdiction.

E 101.3 Component Identification. System components shall be properly identified as to the manufacturer.

E 101.4 Maintenance and Inspection. Mechanical and plumbing systems, materials, and appurtenances, both existing and new, of a premise under the Authority Having Jurisdiction, shall be maintained in operating conditions. Devices or safeguards required by this appendix shall be maintained in accordance with the standard edition under which installed. The owner or the owner's designated agent shall be responsible for the maintenance of mechanical and plumbing systems. To determine compliance with this subsection, the Authority Having Jurisdiction shall be permitted to cause a system to be reinspected.

E 101.5 Material Compatibility. Onsite wastewater treatment systems shall be constructed of materials that are compatible with the type of pipe and fitting materials, water treatment, and water conditions in the system.

E 101.6 Minimum Water Quality Requirements. The minimum output water quality of an onsite wastewater treatment system shall meet the potable water quality requirements of the adopted direct potable water reuse standards, or in absence, shall comply with the water quality requirements specified by the Authority Having Jurisdiction.

COMMITTEE STATEMENT:

The modification updates the applicability of the newly proposed Appendix E from one-and two-unit "residential buildings" to one-and two-unit "family dwellings and townhouses." This revision is necessary as there are varying interpretations of what is considered a one- or two-unit residential building.

TOTAL ELIGIBLE TO VOTE: 30

VOTING RESULTS: AFFIRMATIVE: 21 NEGATIVE: 5 ABSTAIN: 2 NOT RETURNED: 2 CRAWFORD, WILLIAMS

EXPLANATION OF AFFIRMATIVE:

LENGER: As the proponent and author, I agree with the poor choice of "family." It was referring to the low microbiological risk within a household. I will address the issue in public comments. As to the need for more input, I disagree. Science does not work on consensus. The proposed appendix lays out all commonly known treatment technologies and all industry-standard stages. This is already being done, and the AHJ can approve a system, regardless of this appendix, if it chooses to do so. It also could be an engineered system.

EXPLANATION OF NEGATIVE:

CUDAHY: I concur with Jim Kendzel.

KENDZEL: It is understood that Appendices to WE•Stand can be considered for adoption at the local level. This proposal is not ready to be published as an Appendix written on code language. The consideration of adopting the onsite treatment of wastewater for direct potable water use requires a significant more amount of work and involvement of the appropriate government agencies to ensure all public health aspects have been fully considered before any appendix of this nature is published.

KOELLER: I do not agree that substitution of the word "family" for the word "residential" is appropriate. We all KNOW what a residential dwelling is, but it appears that we will now be required to actually define the word "family!" Furthermore, the committee's statement that there are "varying interpretations of what is considered a one- or two-unit residential building" is not explained. What "interpretations" are being referred to? Will the change to "family" INCREASE the number of "misinterpretations?"

PAPE: Agree with John Koeller's statement.

WHITE: I do not support these proposals related to direct potable water reuse and believe more clarification is needed.

EXPLANATION OF ABSTAIN:

BARNES: I concur with the American Supply Association (Jim Kendzel) and Koeller and Company's (John Koeller) comments. More discussion on this topic is needed.

MCLEOD: I concur with Jim Kendzel.



CODES ADMINISTRATION

Proposals

Item #: 125

WEStand 2023 Section: E 102.0 - E 102.1

SUBMITTER: Markus Lenger
Chair, WE-Stand Direct Potable Water Reuse Task Group

RECOMMENDATION:
Add new text

E 102.0 Definitions.

E 102.1 General. For purposes of this appendix, the following definitions shall apply:

Biological Oxygen Demand (BOD). The amount of dissolved oxygen required by organisms to break down organic matter under aerobic conditions at a specific temperature. This value, measured in parts per million (ppm) (mg/L), is used as an indicator of wastewater treatment effectiveness.

Biological Treatment. Water treatment by means of aerobic or anerobic bioremediation using microbes or fungi.

Chemical Disinfection. Sterilization using a chemical reaction or oxidation to either kill or inhibit the RNA to DNA transcription, rendering pathogens harmless.

Chlorination. Sterilization using chlorine to either kill or inhibit the RNA to DNA transcription, rendering pathogens harmless.

Coagulation. A process which introduces small, highly charged molecules into water to destabilize the charges on particles, colloids, or oily materials in suspension increasing solid removal efficiency.

Direct Potable Water Reuse (DPR). Multiple phases of advanced water purification to transform treated wastewater into a safe, reliable drinking water supply.

Flocculation. A process in which clays, polymers or other small charged particles become attached and form a fragile structure, a floc.

Heat Sterilization. An act of destroying all forms of life on and in bacteriological media, foods, hospital supplies, and other materials by means of moist or dry heat.

Membrane Filtration. A physical process to separate substances via membranes which serve as thin layers of semi-permeable material that separate substances when a driving force is applied across the membrane.

Ozonation. The process of treating with ozone, often as part of a purification process.

Potable Water. Water that is satisfactory for drinking, culinary, and domestic purposes and that meets the requirements of the health Authority Having Jurisdiction.

SUBSTANTIATION:

The proposed definitions provide clarity and support the recommendations of this appendix. All treatment types are appropriately defined along with other terms which may not be common knowledge to users of the WE-Stand. For consistency, the definition for "potable water" correlates with the language provided in Chapter 2 (Definitions). Furthermore, these definitions offer users of the appendix with the necessary information to understand the listed system requirements and treatment types.

COMMITTEE ACTION: ACCEPT AS AMENDED BY THE TC

E 102.0 Definitions.

E 102.1 General. For purposes of this appendix, the following definitions shall apply:

~~Biological~~ **Biochemical Oxygen Demand (BOD).** The amount of dissolved oxygen required by organisms to break down organic matter under aerobic conditions at a specific temperature. This value, measured in parts per million (ppm) (mg/L), is used as an indicator of wastewater treatment effectiveness.

Biological Treatment. Water treatment by means of aerobic or anerobic bioremediation using microbes or fungi.

Chemical Disinfection. Sterilization using a chemical reaction or oxidation to either kill or inhibit the RNA to DNA transcription, rendering pathogens harmless.

Chlorination. Sterilization using chlorine to either kill or inhibit the RNA to DNA transcription, rendering pathogens harmless.

Coagulation. A process which introduces small, highly charged molecules into water to destabilize the charges on particles, colloids, or oily materials in suspension increasing solid removal efficiency.

Direct Potable Water Reuse (DPR). Multiple phases of advanced water purification to transform treated wastewater into a safe, reliable drinking water supply.

Flocculation. A process in which clays, polymers or other small charged particles become attached and form a fragile structure, a floc.

Heat Sterilization. An act of destroying all forms of life on and in bacteriological media, foods, hospital supplies, and other materials by means of moist or dry heat.

Membrane Filtration. A physical process to separate substances via membranes which serve as thin layers of semi-permeable material that separate substances when a driving force is applied across the membrane.

Ozonation. The process of treating with ozone, often as part of a purification process.

Potable Water. Water that is satisfactory for drinking, culinary, and domestic purposes and that meets the requirements of the health Authority Having Jurisdiction.

COMMITTEE STATEMENT:

The modification updates the term "biological" to "biochemical" for clarity regarding the definition for oxygen demand.

TOTAL ELIGIBLE TO VOTE: 30

VOTING RESULTS: AFFIRMATIVE: 23 NEGATIVE: 3 ABSTAIN: 2 NOT RETURNED: 2 CRAWFORD, WILLIAMS

EXPLANATION OF NEGATIVE:

KENZEL: It is understood that Appendices to WE•Stand can be considered for adoption at the local level. This proposal is not ready to be published as an Appendix written on code language. The consideration of adopting the onsite treatment of wastewater for direct potable water use requires a significant more amount of work and involvement of the appropriate government agencies to ensure all public health aspects have been fully considered before any appendix of this nature is published.

SMITH: I agree as written here from Chuck White: "I do not support these proposals related to direct potable water reuse and believe more clarification is needed."

WHITE: I do not support these proposals related to direct potable water reuse and believe more clarification is needed.

EXPLANATION OF ABSTAIN:

BARNES: I am changing my vote to abstain which is consistent with my vote for Item #124. More discussion on this topic is needed.

MCLEOD: More discussion is needed.



CODES ADMINISTRATION

Proposals

Item #: 126

WEStand 2023 Section: E 103.0 - E 103.7

SUBMITTER: Markus Lenger
Chair, WE-Stand Direct Potable Water Reuse Task Group

RECOMMENDATION:
Add new text

E 103.0 System Requirements.

E 103.1 Connections to Potable Water Supply. Onsite wastewater treatment systems shall have no direct connection to any potable water supply. Potable water shall be permitted to be used as makeup water for an onsite wastewater treatment system provided the potable water supply connection is protected by an airgap in accordance with the plumbing code.

E 103.1.1 Cross-Contamination. No person shall make a connection or allow one to exist between pipes or conduits carrying domestic water supplied by a public or private building supply system, and pipes, conduits, or fixtures containing or carrying water from any other source or containing or carrying water that has been used for any purpose whatsoever, or piping carrying chemicals, liquids, gases, or substances whatsoever, unless there is provided a backflow prevention device approved for the potential hazard and maintained in accordance with the plumbing code. Each point of use shall be separately protected where potential cross-contamination of individual units exists.

E 103.1.2 Cross-Connection Inspection and Testing. A cross-connection test is required in accordance with Section 601.11.2. Before the building is occupied or the system is activated, the installer shall perform the initial cross-connection test in the presence of the Authority Having Jurisdiction. The test shall be ruled successful by the Authority Having Jurisdiction before final approval is granted.

E 103.2 Overflow. Raw water overflow shall be connected directly to the plumbing drainage system. The overflow piping shall be provided with a backwater valve at the point of connection to the plumbing drainage system. The backwater valve shall be accessible for inspection and maintenance.

E 103.3 Treated Water. Treated water shall be connected directly to an aerated storage tank capable of maintaining water quality in accordance with Section E 101.6. Storage capacity shall be determined based on the estimated daily volume of wastewater and usage of potable water.

E 103.4 Diverter Valves. The onsite wastewater treatment system shall connect to the sanitary drainage system through a diverter valve(s) approved by the Authority Having Jurisdiction. At a minimum, a diverter valve shall be installed between the main drain line and the onsite treatment system. Additional diverter valves shall be permitted to be installed at other locations as specified by the registered design professional and the Authority Having Jurisdiction.

E 103.5 Isolation Valves. A means of isolation shall be provided between the treatment system and the plumbing system. Automatic shutoff shall be provided in accordance with Section E 103.6.

E 103.6 Monitoring and Controls. Onsite wastewater treatment systems shall be provided with a means of continuous monitoring of the treatment stages and shall be provided with a means of automatic shutoff when a malfunction occurs or when measured parameters are outside of the acceptable ranges specified by the Authority Having Jurisdiction. In the event of a malfunction, raw water shall be diverted to the sewage system, and the diverter valve shall be reset only once safe operating conditions are met.

Notes:

(1) Biological and pathogen parameters may only be measured by a qualified testing laboratory. Such testing requires multi-day turnaround for results. To control a system in real-time and react to water quality and flow fluctuations, reliable online measurement technology should be deployed.

(2) The following types of sensors are available in the industry and provide reliable outputs:

- (a) Flow rate
- (b) Pressure
- (c) Solid content
- (d) ORP

- (e) Temperature
- (f) pH
- (g) Dissolved oxygen
- (h) Turbidity
- (i) Total Suspended Solids
- (j) Conductivity
- (k) Gas

E 103.7 Validation. Where required by the Authority Having Jurisdiction, treatment processes shall be tested to verify the pathogen reduction performance. The treatment processes shall be validated through third-party component validation or field verification using challenge testing. The results of the third-party component validation and/or challenge testing shall be summarized in a validation report prepared by a registered design professional. The validation report shall document the treatment technology's log reduction performance, including information on the operating conditions and surrogate parameters.

SUBSTANTIATION:

Section E 103.0 (System Requirements) dictates the provisions for protecting the potable water supply along with cross-connection testing. In particular, Section E 103.1.1 (Cross-Contamination) was carried over from the plumbing code. Requirements have also been laid out to address raw water overflow and approved discharge to the plumbing drainage system. Furthermore, diverter valves at a minimum must be installed between the main drain line and the onsite treatment system. The installation of these valves is needed to connect the onsite wastewater treatment system to the sanitary drainage system. Additional diverter valves may also be installed per the AHJ or the registered design professional depending on the selected design.

Section E 103.5 (Isolation Valves) and Section E 103.6 (Monitoring and Controls) address water quality parameters, method of monitoring such parameters, and isolation of treatment stages/systems. All biological and pathogen parameters, as well as a host of other important water parameter readings, can only be measured in a qualified laboratory, and therefore, require a multi-day turnaround for test results. To control a system in real-time and react to water quality and flow fluctuations, reliable online measurement technology must be deployed. Sensors that are currently available and affordable producing reliable outputs are flow rate, solid content, ORP, temperature, pH, dissolved oxygen, turbidity, total suspended solids, conductivity, and a selection of gas sensors.

While critical water parameters such as Total Coliform, e-coli, and other pathogens as well as COD and BOD cannot be monitored online, it is still possible to assess system health via the sensors mentioned above. For example, ozone disinfection efficiency can be reliably measured using an ORP measurement. Filter removal efficiency can be measured via TDS, conductivity, or turbidity.

Therefore, a control system should be designed to monitor the system's performance and initiate a system safety shut down if it detects unsafe treatment conditions or unacceptable output water quality. A remote request for service with relevant error codes and diagnostic information can be sent to the remote monitoring system. Automated safety shutdowns and lockouts ensure operational safety and should alleviate health concerns due to output water quality, system malfunction, or user tampering.

COMMITTEE ACTION: ACCEPT AS AMENDED BY THE TC

E 103.0 System Requirements.

E 103.1 Connections to Potable Water Supply. Onsite wastewater treatment systems shall have no direct connection to any potable water supply. Potable water shall be permitted to be used as makeup water for an onsite wastewater treatment system provided the potable water supply connection is protected by an airgap in accordance with the plumbing code.

E 103.1.1 Cross-Contamination. No person shall make a connection or allow one to exist between pipes or conduits carrying domestic water supplied by a public or private building supply system, and pipes, conduits, or fixtures containing or carrying water from any other source or containing or carrying water that has been used for any purpose whatsoever, or piping carrying chemicals, liquids, gases, or substances whatsoever, unless there is provided a backflow prevention device approved for the potential hazard and maintained in accordance with the plumbing code. Each point of use shall be separately protected where potential cross-contamination of individual units exists.

E 103.1.2 Cross-Connection Inspection and Testing. A cross-connection test is required in accordance with Section 601.11.2. Before the building is occupied or the system is activated, the installer shall perform the initial cross-connection test in the presence of the Authority Having Jurisdiction. The test shall be ruled successful by the Authority Having Jurisdiction before final approval is granted.

E 103.2 Overflow. Raw water overflow shall be connected directly to the plumbing drainage system. The overflow piping shall be provided with a backwater valve at the point of connection to the plumbing drainage system. The backwater valve shall be accessible for inspection and maintenance.

E 103.3 Treated Water. Treated water shall be connected directly to an aerated storage tank capable of maintaining water quality in accordance with Section E 101.6. Storage capacity shall be determined based on the estimated daily volume of wastewater and usage of potable water.

E 103.4 Diverter Valves. The onsite wastewater treatment system shall connect to the sanitary drainage system through a diverter valve(s) approved by the Authority Having Jurisdiction. At a minimum, a diverter valve shall be installed between the main drain line and the onsite treatment system. Additional diverter valves shall be permitted to be installed at other locations as specified by the registered design professional and the Authority Having Jurisdiction.

E 103.5 Isolation Valves. A means of isolation shall be provided between the treatment system and the plumbing system. Automatic shutoff shall be provided in accordance with Section E 103.6.

E 103.6 Monitoring and Controls. Onsite wastewater treatment systems shall be provided with a means of continuous monitoring of the treatment stages and shall be provided with a means of automatic shutoff when a malfunction occurs or when measured parameters are outside of the acceptable ranges specified by the Authority Having Jurisdiction. In the event of a malfunction, raw water shall be diverted to the sewage system, and the diverter valve shall be reset only once safe operating conditions are met.

Notes:

(1) Biological and pathogen parameters may only be measured by a qualified testing laboratory. Such testing requires multi-day turnaround for results. To control a system in real-time and react to water quality and flow fluctuations, reliable online measurement technology should be deployed.

(2) The following types of sensors are available in the industry and provide reliable outputs:

- (a) Flow rate
- (b) Pressure
- (c) Solid content
- (d) Oxidation-reduction potential (ORP)
- (e) Temperature
- (f) pH
- (g) Dissolved oxygen
- (h) Turbidity
- (i) Total Suspended Solids
- (j) Conductivity
- (k) Gas

E 103.7 Validation. Where required by the Authority Having Jurisdiction, treatment processes shall be tested to verify the pathogen reduction performance. The treatment processes shall be validated through third-party component validation or field verification using challenge testing. The results of the third-party component validation and/or challenge testing shall be summarized in a validation report prepared by a registered design professional. The validation report shall document the treatment technology's log reduction performance, including information on the operating conditions and surrogate parameters.

COMMITTEE STATEMENT:

The proposal is be modified to expand the acronym for ORP, oxidation-reduction potential.

TOTAL ELIGIBLE TO VOTE: 30

VOTING RESULTS: AFFIRMATIVE: 23 NEGATIVE: 4 NOT RETURNED: 3 CRAWFORD, MCLEOD, WILLIAMS

EXPLANATION OF NEGATIVE:

BARNES: I agree with the comment by the American Supply Association (Jim Kendzel).

KENDZEL: It is understood that Appendices to WE•Stand can be considered for adoption at the local level. This proposal is not ready to be published as an Appendix written on code language. The consideration of adopting the onsite treatment of wastewater for direct potable water use requires a significant more amount of work and involvement of the appropriate government agencies to ensure all public health aspects have been fully considered before any appendix of this nature is published.

SMITH: I agree with Chuck White as shown here: "I do not support these proposals related to direct potable water reuse and believe more clarification is needed."

WHITE: I do not support these proposals related to direct potable water reuse and believe more clarification is needed.



CODES ADMINISTRATION

Proposals

Item #: 127

WEStand 2023 Section: E 104.0 - E 104.4.4.1, Figure E 104.1, Table 1201.1

SUBMITTER: Markus Lenger
Chair, WE-Stand Direct Potable Water Reuse Task Group

RECOMMENDATION:
Add new text

E 104.0 System Design.

E 104.1 General. Onsite wastewater treatment systems shall be designed in accordance with this appendix and installed by a registered design professional. Onsite wastewater treatment systems covered by this appendix shall include the following treatment stages:

Stage 1: Solid separation in accordance with Section E 104.2.

Stage 2: Primary treatment in accordance with Section E 104.3.

Stage 3: Secondary treatment in accordance with Section E 104.4.

Stage 4: Electrolyte addition and remineralization.

(See Figure E 104.1 for a flow diagram of treatment stages utilized in DPR systems.)

Note: To eliminate a single point of failure in the sterilization stage, an additional method of filtration is recommended between Stage 3 and Stage 4. The recommended level of filtration is 0.05 micron (0.05 μm).

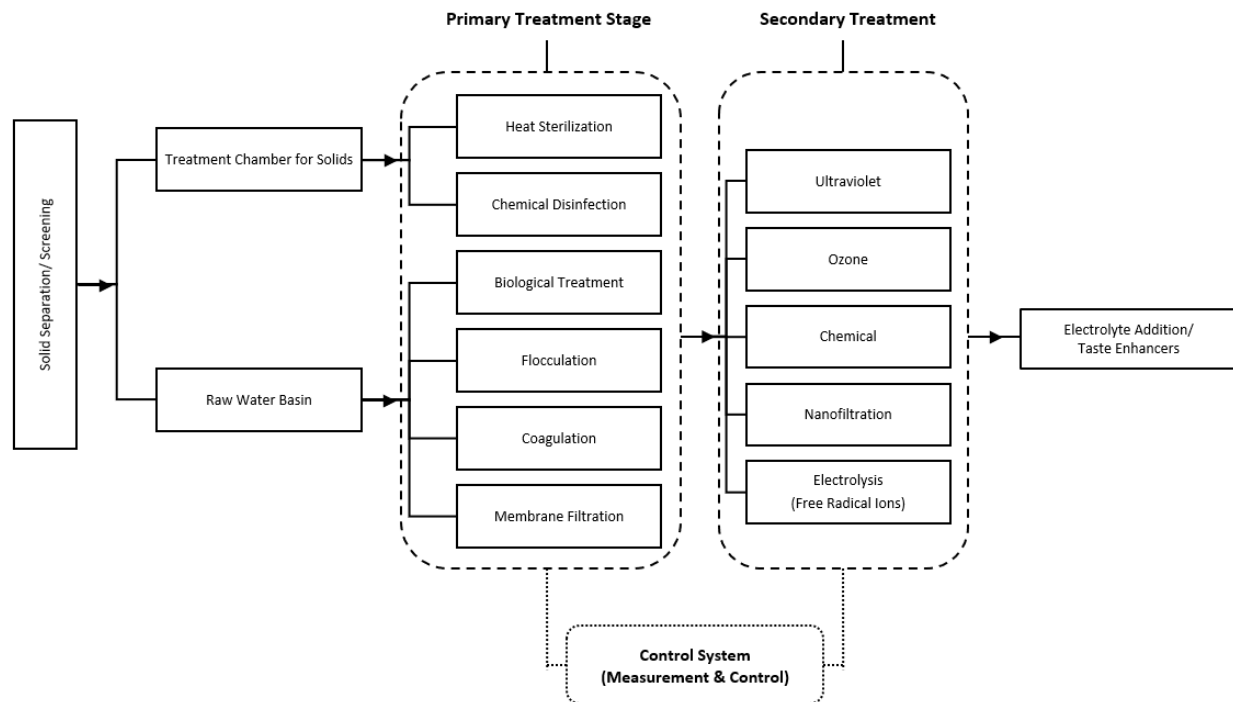

FIGURE E 104.1
ONSITE WASTEWATER TREATMENT STAGES FOR DPR

E 104.2 Solid Separation. Collected wastewater shall pass through a filter screen of not less than 18 mesh (1 mm) prior to primary treatment. Separated solids and organic matter from the wastewater shall be diverted to a treatment chamber. Wastewater shall be diverted to a designated basin or storage tank.

E 104.3 Primary Treatment. Separated solids and organic matter shall undergo heat sterilization or chemical disinfection prior to removal. Primary treatment for wastewater shall be completed by one or more of the following means:

- (1) Biological treatment,
- (2) Flocculation,
- (3) Coagulation,
- (4) Membrane filtration, or
- (5) Other equivalent method of treatment as approved by the Authority Having Jurisdiction.

Minimum standards for the biological oxygen demand (BOD), total suspended solids (TSS), and pH limitations shall be in accordance with the Authority Having Jurisdiction.

E 104.4 Secondary Treatment. Secondary treatment for wastewater shall be in accordance with this section, and Section E 104.4.1 through Section E 104.4.4.1. Treatment shall be completed by one or more of the following means:

- (1) Ultraviolet sterilization,
- (2) Ozone sterilization,
- (3) Chemical disinfection,
- (4) Nanofiltration,
- (5) Electrolysis, or
- (6) Other equivalent method of treatment as approved by the Authority Having Jurisdiction.

E 104.4.1 UV Sterilization. Where utilized, ultraviolet microbiological treatment systems shall be in accordance with NSF/ANSI 55. A minimum of 2 inline filters, one 5 micron (5 µm) filter followed by one 0.5-1 micron (0.5-1 µm) filter, shall be installed prior to the UV disinfection system. UV systems shall deliver a minimum of 40 mJ/cm² (2.45 E-4 Btu/in²) at the minimum intensity specified by the manufacturer at the flow rates specified for the application.

E 104.4.2 Ozone. Design, installation, and commissioning of ozone systems shall comply with AWWA F120. Ozone systems shall be equipped with an airflow switch monitored by a controller as well as an oxidation reduction potential (ORP) sensor. The ORP reading of water shall not be less than 500 mV near the exit point of the system.

E 104.4.3 Chlorination/Dechlorination. In systems where chlorine is used for secondary treatment, the chlorine dosage shall be determined by the total chlorine level required for disinfection, and a means of dechlorination shall be provided to meet the potable water quality parameters for free chlorine as approved by the Authority Having Jurisdiction. Plans and procedures for dechlorination shall be in accordance with AWWA C655. Chlorine disinfection systems shall be equipped with ORP sensors, or equivalent, to determine the concentration of free available chlorine.

E 104.4.4 Filtration. The level of filtration shall be selected in accordance with the water quality requirements of Section E 101.6.

E 104.4.4.1 Reverse Osmosis (RO). Where installed, reverse osmosis water treatment systems shall be listed in accordance with NSF/ANSI 58 and ASSE 1086, or other equivalent standards, and shall be installed and maintained in accordance with the manufacturer's specifications. Reverse osmosis water treatment systems shall be equipped with automatic shutoff valves to prevent discharge when there is no call for producing treated water. RO systems shall be selected and sized based on the following conditions:

- (1) Estimated volume of water to be disinfected (gal/day) (L/day).
- (2) Not less than a 20 percent variation in volume.
- (3) Lowest expected water temperature.

**TABLE 1201.1
REFERENCED STANDARDS**

STANDARD NUMBER- YEAR	STANDARD TITLE	REFERENCED SECTION
ASSE 1086-2020*	Performance Specification for Reverse Osmosis Water Efficiency – Drinking Water	E 104.4.4.1
AWWA C655-2009*	Field Dechlorination	E 104.4.3
AWWA F120-2018*	Ozone Systems for Water	E 104.4.2
NSF/ANSI 55-2020*	Ultraviolet Microbiological Water Treatment Systems	E 104.4.1
NSF/ANSI 58-2020*	Reverse Osmosis Drinking Water Treatment Systems	E 104.4.4.1

(portion of table not shown remains unchanged)

Note: ASSE 1086, AWWA C655, AWWA F120, NSF/ANSI 55, and NSF/ANSI 58 meet the requirements for mandatory referenced standards in accordance with Section 15.0 of IAPMO's Regulations Governing Consensus Development of the Water Efficiency and Sanitation Standard.

SUBSTANTIATION:

The stages of treatment for a DPR system include solid separation, primary treatment, secondary treatment, and electrolyte addition. Where solids are separated out of the collected raw water, they must be treated before safe removal and approved disposal.

The primary treatment stage includes sterilization via heat, chemical disinfection, biological treatment, flocculation, coagulation, or membrane filtration. A means of secondary treatment is then required to further purify the wastewater through additional processes listed in Section E 104.4. Each of these treatment types are supported by definitions proposed in previous items by this Task Group. Figure E 104.1 also serves as a process flow diagram of the required treatment stages. Overall the layout of the section clearly states the needed treatment stages and appropriate methods of completing such treatment to ensure water quality and safety.

UV sterilization is an environmentally friendly method of treatment which removes a vast majority of harmful waterborne microorganisms. NSF 55 covers UV microbiological water treatment systems and components for point-of-use and point-of-entry (POE) applications. The standard is intended to establish minimum requirements for the reduction of microorganisms using ultraviolet (UV) radiation.

AWWA F120 provides a minimum set of requirements for ozone systems for the treatment of potable water, wastewater, reclaimed water, and storm water. This standard is intended to assist with the design, procurement, installation, and commissioning of ozone systems.

AWWA C655 describes procedures, materials, and requirements for the dechlorination of chlorinated water discharges. It includes current dechlorination regulations, chemical and nonchemical dechlorination, dechlorination plans and procedures, dechlorination methods, and verification.

NSF 58 establishes minimum requirements for materials, design and construction, and performance of reverse osmosis (RO) drinking water treatment systems. This Standard also specifies the minimum product literature that manufacturers shall supply to authorized representatives and owners, as well as the minimum service-related obligations that manufacturers shall extend to system owners.

ASSE 1086 covers water efficiency, automatic shut-off valves, and flow restrictor requirements for residential RO systems and performance testing to address the membrane life concerns of high efficiency RO membranes. This standard includes test requirements for complete systems or components (RO membrane, automatic shut off valve, flow restrictor).

Furthermore, the required level of filtration was selected based on particle sizing of bacteria and viruses. As the selected micron size effectively becomes a measure of the efficiency of a filter in terms of purity, it was necessary to provide the minimum level of filtration for secondary treatment. Nanofiltration was selected as it removes most organic molecules and nearly all viruses.

Reverse osmosis removes turbidity, including microbes and virtually all dissolved substances. In addition, this method of filtration also removes many harmful and healthy minerals. In cases where RO systems are employed, it is necessary to add minerals back into the water to increase pH and decrease corrosion potential within the residential plumbing system.

COMMITTEE ACTION: ACCEPT AS AMENDED BY THE TC

E 104.0 System Design.

E 104.1 General. Onsite wastewater treatment systems shall be designed in accordance with this appendix and installed by a registered design professional. Onsite wastewater treatment systems covered by this appendix shall include the following treatment stages:

Stage 1: Solid separation in accordance with Section E 104.2.

Stage 2: Primary treatment in accordance with Section E 104.3.

Stage 3: Secondary treatment in accordance with Section E 104.4.

Stage 4: Electrolyte addition and remineralization.

(See Figure E 104.1 for a flow diagram of treatment stages utilized in DPR systems.)

Note: To eliminate a single point of failure in the sterilization stage, an additional method of filtration is recommended between Stage 3 and Stage 4. The recommended level of filtration is 0.05 micron (0.05 µm).

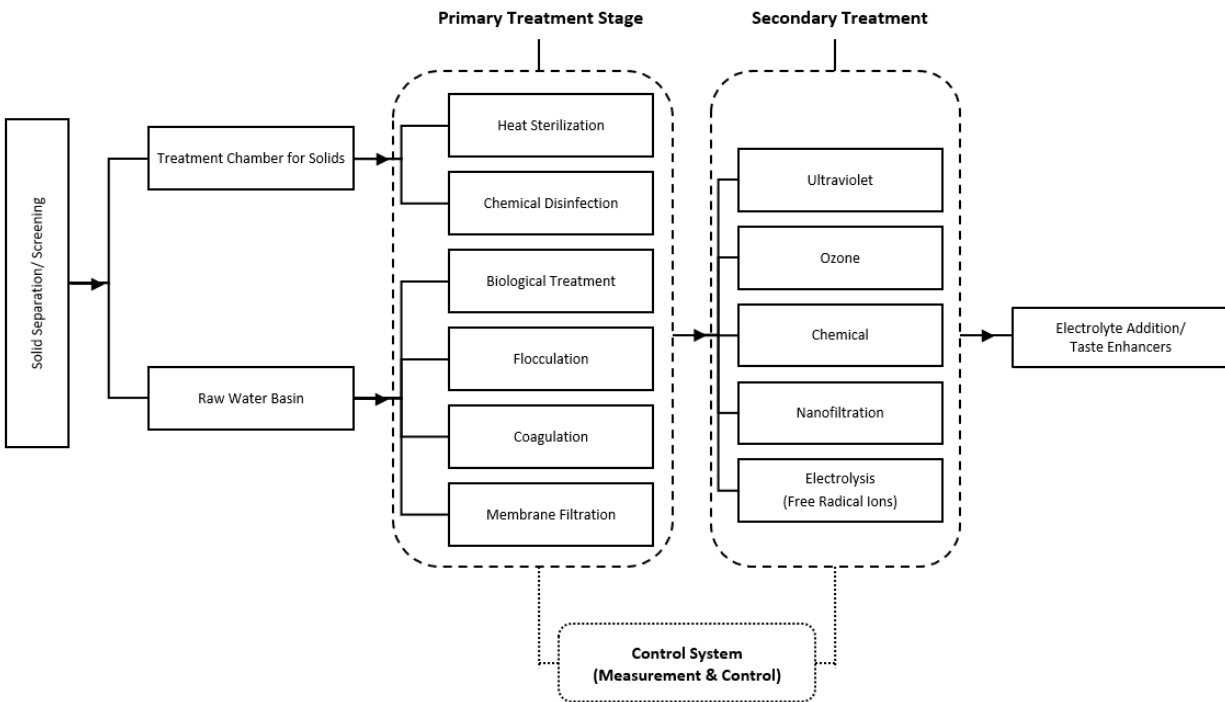

FIGURE E 104.1
ONSITE WASTEWATER TREATMENT STAGES FOR DPR

E 104.2 Solid Separation. Collected wastewater shall pass through a filter screen of not less than 18 mesh (1 mm) prior to primary treatment. Separated solids and organic matter from the wastewater shall be diverted to a treatment chamber. Wastewater shall be diverted to a designated basin or storage tank.

E 104.3 Primary Treatment. Separated solids and organic matter shall undergo heat sterilization or chemical disinfection prior to removal. Primary treatment for wastewater shall be completed by one or more of the following means:

- (1) Biological treatment,
- (2) Flocculation,
- (3) Coagulation,
- (4) Membrane filtration, or
- (5) Other equivalent method of treatment as approved by the Authority Having Jurisdiction.

Minimum standards for the ~~biological-biochemical~~ oxygen demand (BOD), total suspended solids (TSS), and pH limitations shall be in accordance with the Authority Having Jurisdiction.

E 104.4 Secondary Treatment. Secondary treatment for wastewater shall be in accordance with this section, and Section E 104.4.1 through Section E 104.4.4.1. Treatment shall be completed by one or more of the following means:

- (1) Ultraviolet sterilization,
- (2) Ozone sterilization,
- (3) Chemical disinfection,
- (4) Nanofiltration,
- (5) Electrolysis, or
- (6) Other equivalent method of treatment as approved by the Authority Having Jurisdiction.

E 104.4.1 UV Sterilization. Where utilized, ultraviolet microbiological treatment systems shall be in accordance with NSF/ANSI 55, Class A systems. A minimum of 2 inline filters, one 5 micron (5 μm) filter followed by one 0.5-1 micron (0.5-1 μm) filter, shall be installed prior to the UV disinfection system. ~~UV systems shall deliver a minimum of 40 mJ/cm^2 (2.45 E-4 Btu/in²) at the minimum intensity specified by the manufacturer at the flow rates specified for the application.~~

E 104.4.2 Ozone. Design, installation, and commissioning of ozone systems shall comply with AWWA F120. Ozone systems shall be equipped with an airflow switch monitored by a controller as well as an oxidation reduction potential (ORP) sensor. The ORP reading of water shall not be less than 500 mV near the exit point of the system.

E 104.4.3 Chlorination/Dechlorination. In systems where chlorine is used for secondary treatment, the chlorine dosage shall be determined by the total chlorine level required for disinfection, and a means of dechlorination shall be

provided to meet the potable water quality parameters for free chlorine as approved by the Authority Having Jurisdiction. Plans and procedures for dechlorination shall be in accordance with AWWA C655. Chlorine disinfection systems shall be equipped with ORP sensors, or equivalent, to determine the concentration of free available chlorine.

E 104.4.4 Filtration. The level of filtration shall be selected in accordance with the water quality requirements of Section E 101.6.

E 104.4.4.1 Reverse Osmosis (RO). Where installed, reverse osmosis water treatment systems shall be listed in accordance with NSF/ANSI 58 and ASSE 1086, or other equivalent standards, and shall be installed and maintained in accordance with the manufacturer’s specifications. Reverse osmosis water treatment systems shall be equipped with automatic shutoff valves to prevent discharge when there is no call for producing treated water. RO systems shall be selected and sized based on the following conditions:

- (1) Estimated volume of water to be disinfected (gal/day) (L/day).
- (2) Not less than a 20 percent variation in volume.
- (3) Lowest expected water temperature.

**TABLE 1201.1
REFERENCED STANDARDS**

STANDARD NUMBER- YEAR	STANDARD TITLE	REFERENCED SECTION
ASSE 1086-2020*	Performance Specification for Reverse Osmosis Water Efficiency – Drinking Water	E 104.4.4.1
AWWA C655-2009*	Field Dechlorination	E 104.4.3
AWWA F120-2018*	Ozone Systems for Water	E 104.4.2
NSF/ANSI 55-2020*	Ultraviolet Microbiological Water Treatment Systems	E 104.4.1
NSF/ANSI 58-2020*	Reverse Osmosis Drinking Water Treatment Systems	E 104.4.4.1

(portion of table not shown remains unchanged)

COMMITTEE STATEMENT:

Since the provided requirement for UV systems to deliver a minimum of 40 mJ/cm² is consistent with Class A systems in NSF/ANSI 55, the proposal is being modified to make this distinction and remove unneeded language.

TOTAL ELIGIBLE TO VOTE: 30

VOTING RESULTS: AFFIRMATIVE: 20 NEGATIVE: 8 NOT RETURNED: 2 CRAWFORD, WILLIAMS

EXPLANATION OF AFFIRMATIVE:

KOELLER: I agree with the comments by Mr. Markus Lenger.

LENGER: As the proponent, I agree that references to the existing standards need to be revised/clarified as they are used to reference desired water quality parameters, not the technology used. As to the statements that the technologies listed are not able to achieve the stated water quality, they are false. The listed treatment trains achieve the desired quality, as they are used in all existing treatment systems. The descriptions are not specific enough to state that the performance is NOT achievable. The purpose of this appendix is to leave that up to the designers.

EXPLANATION OF NEGATIVE:

ALLEN: I support the intent of this proposal and had voted affirmative. However, it’s come to my attention that the listed product standards for the RO section conflict with the quality of incoming water. This seems like an easy fix for public comment.

Standard 58 section 1.2: “The point-of-use (POU) RO drinking water treatment systems addressed by this standard are designed to be used for the reduction of specific substances that may be present in drinking water (public or private) considered to be microbiologically safe and of known quality”.

From 1086: “Residential Reverse Osmosis (RO) systems are used to treat drinking water.”

BARNES: I support the intent of this proposal however I cannot support it as written. Products certified to the referenced standards (NSF 55, 58 and 1086) are intended to be used on a potable water source. The following are quotes directly from those standards:

NSF/ANSI 58 section 1.2: "The point-of-use (POU) RO drinking water treatment systems addressed by this standard are designed to be used for the reduction of specific substances that may be present in drinking water (public or private) considered to be microbiologically safe and of known quality."

ASSE 1086: "Residential Reverse Osmosis (RO) systems are used to treat drinking water."

NSF/ANSI 55: "Systems covered by this standard are not intended for the treatment of water that has an obvious contamination or intentional source, such as raw sewage, nor are systems intended to convert wastewater to drinking water. The systems are intended to be installed on visually clear water (not colored, cloudy, or turbid)."

The quality of water that will result from the primary treatment stage defined in this proposal will not meet potable water standards and therefore it would be inappropriate to apply the above listed standards to this application. Products certified to these standards may not perform as expected in the proposed wastewater treatment application.

KENDZEL: It is understood that Appendices to WE•Stand can be considered for adoption at the local level. This proposal is not ready to be published as an Appendix written on code language. The consideration of adopting the onsite treatment of wastewater for direct potable water use requires a significant more amount of work and involvement of the appropriate government agencies to ensure all public health aspects have been fully considered before any appendix of this nature is published.

MCLEOD: The standards need to be investigated in more detail.

PREMER: I agree with the comments listed, nothing more to add.

SMITH: I agree with Chuck White as written here: "I do not support these proposals related to direct potable water reuse and believe more clarification is needed. Additionally, this proposal says these will be installed by registered design professionals. Design professionals will likely not do the installation."

TABAKH: I agree with the comments listed.

WHITE: I do not support these proposals related to direct potable water reuse and believe more clarification is needed. Additionally, this proposal says these will be installed by registered design professionals. Design professionals will likely not do the installation.



CODES ADMINISTRATION

Proposals

Item #: 128

WEStand 2023 Section: E 105.0 - E 105.5

SUBMITTER: Markus Lenger
Chair, WE-Stand Direct Potable Water Reuse Task Group

RECOMMENDATION:
Add new text

E 105.0 Commissioning.

E 105.1 General. Onsite wastewater treatment systems for potable use shall be commissioned in accordance with the requirements of Section E 105.2 through Section E 105.5.

E 105.2 Requirements. Commissioning for onsite wastewater treatment systems shall be included in the design and construction processes of the project. Commissioning shall be performed by a person who demonstrates competency in commissioning onsite wastewater treatment systems as required by the Authority Having Jurisdiction.

E 105.3 Plan. The construction documents shall include the commissioning plan for the onsite wastewater treatment system. The commissioning plan shall be approved by the Authority Having Jurisdiction prior to commissioning the onsite wastewater treatment system. The commissioning plan shall include the following:

- (1) General project information.
- (2) Equipment to be tested, including the test methodology.
- (3) Processes to be tested.
- (4) Criteria or process for testing.
- (5) Criteria for acceptance.
- (6) Commissioning team contact information.
- (7) Commissioning process activities, schedules, and responsibilities.
- (8) Plans for the completion of functional performance testing, post construction documentation and training, and the commissioning report.

E 105.4 Performance Testing. Performance tests shall verify that the installation and operation of the equipment of the onsite wastewater treatment system are in accordance with the approved plans and specifications. The performance test report shall include the equipment tested, the testing methods utilized, and proof of proper calibration of the equipment.

E 105.5 Commissioning Report. The commissioning report shall be submitted to the Authority Having Jurisdiction.

SUBSTANTIATION:

The final section to address pertains to the commissioning of onsite wastewater treatment systems. The language mimics the commissioning requirements specified for the other onsite treatment systems listed within the WE-Stand. For consistency with provisions pertaining to the same topic, it was necessary to correlate such information.

COMMITTEE ACTION: ACCEPT AS SUBMITTED

TOTAL ELIGIBLE TO VOTE: 30

VOTING RESULTS: AFFIRMATIVE: 23 NEGATIVE: 5 NOT RETURNED: 2 CRAWFORD, WILLIAMS

EXPLANATION OF NEGATIVE:

BARNES: I agree with the comment by the American Supply Association (Jim Kendzel).

KENDZEL: It is understood that Appendices to WE-Stand can be considered for adoption at the local level. This proposal is not ready to be published as an Appendix written on code language. The consideration of adopting the onsite treatment of wastewater for direct potable water use requires a significant more amount of work and

involvement of the appropriate government agencies to ensure all public health aspects have been fully considered before any appendix of this nature is published.

MCLEOD: I agree with Jim Kendzel and hope the task group can get there soon.

SMITH: I agree with Chuck White as written here: "I do not support these proposals related to direct potable water reuse and believe more clarification is needed."

WHITE: I do not support these proposals related to direct potable water reuse and believe more clarification is needed.



CODES ADMINISTRATION

Proposals

Item #: 129

WEStand 2023 Section: Appendix F, F 101.0 - F 101.4.1

SUBMITTER: Laura Allen
Chair, WE-Stand Gray Water Ready Plumbing Task Group

RECOMMENDATION:
Add new text

APPENDIX F **GRAY WATER READY PLUMBING**

F 101.0 General.

F 101.1 Purpose. The purpose of this appendix is to lower barriers for the future installation of a gray water system by installing the necessary piping during the construction or remodel of a building.

F 101.2 Scope. This appendix provides requirements for the design and installation of gray water drainage systems for future installation of gray water irrigation or reuse systems in new construction, additions, and retrofits in accordance with Section F 101.3 and Section F 101.4. Gray water systems shall comply with Chapter 6 of this code.

F 101.3 New Construction. Gray water drainage systems shall be installed in new construction of residential buildings in accordance with Section F 101.3.1 through Section F 101.3.3.

Exception: Where ground conditions do not provide percolations, where setbacks cannot be maintained, or other such limitations are prohibited by the plumbing code. Project applicants shall submit documentation satisfactory to the Authority Having Jurisdiction for an exemption.

F 101.3.1 Single-Family Dwellings. For new construction of single-family dwellings, gray water drainage systems shall be installed and connected to at least one clothes washer and at least one primary shower or bathtub.

F 101.3.1.1 Accessory Dwellings. For new construction of accessory dwellings, gray water drainage systems shall be installed and connected to at least one clothes washer and at least one primary shower or bathtub.

Exception: Where an accessory dwelling is constructed without a clothes washer system, dual drainage plumbing shall be installed and connected to at least one primary shower or bathtub.

F 101.3.2 Multi-Family Dwellings. For new construction of multi-family dwellings, gray water drainage systems shall be installed and connected to each common laundry facility and each pool or spa shower.

F 101.3.3 Duplexes. For new construction of duplexes, gray water drainage systems shall be installed and connected to at least one clothes washer and one primary shower or bathtub per dwelling unit.

F 101.4 Additions. Bathroom and laundry room additions in single-family dwellings, duplex dwellings, and accessory dwellings shall require the installation of gray water drainage systems for newly installed showers and washing machines.

F 101.4.1 Alterations and Renovations. Alterations and renovations to a bathroom or laundry room, which alter the drainage piping to showers or washing machines, shall require the installation of gray water drainage piping.

SUBSTANTIATION:

Graywater can be a valuable resource, especially in places with water shortages. Unfortunately, many buildings are plumbed; so it's challenging to retrofit the pipes to access gray water flows for reuse. However, during new construction or renovations of plumbing systems, it is typically easy (and low cost) to keep the graywater pipes separate from blackwater pipes.

This appendix details how to safely and efficiently divert gray water. The Task Group reviewed language from existing ordinances, spoke to gray water installers, and used that information to craft an appendix that would maximize the benefits of gray water while minimizing the impact on builders and future building owners who want to install a gray water system.

For example, some ordinances require all gray water sources to be piped separately, which limits the options for a future owner because the piping ends up deep underground and requires pumping to move it to the landscape. An owner of this building would lose their options for gravity flow, low energy, and gray water systems. If all gray water fixtures were required to be kept separate independently, the future system owner would have more options, but the builders would have extra work. Since some gray water sources generate more of the total house's gray water than others, the Task Group targeted those sources and required them to be plumbed separately.

For example, we require at least one primary bath/shower be plumbed for graywater, but not all the showers. We felt this was the appropriate compromise between making it easy to access the gray water and not being onerous for the builder.

COMMITTEE ACTION: ACCEPT AS AMENDED BY THE TC

APPENDIX F GRAY WATER READY PLUMBING

F 101.0 General.

F 101.1 Purpose. The purpose of this appendix is to lower barriers for the future installation of a gray water system by installing the necessary piping during the construction or remodel of a building.

F 101.2 Scope. This appendix provides requirements for the design and installation of gray water drainage systems for future installation of gray water irrigation or reuse systems in new construction, additions, and retrofits in accordance with Section F 101.3 and Section F 101.4. Gray water systems shall comply with Chapter 6 of this code.

F 101.3 New Construction. Gray water drainage systems shall be installed in new construction of residential buildings in accordance with Section F 101.3.1 through Section F 101.3.3.

Exception: Where ground conditions do not provide percolations, where setbacks cannot be maintained, or other such limitations are prohibited by the plumbing code. Project applicants shall submit documentation satisfactory to the Authority Having Jurisdiction for an exemption.

F 101.3.1 Single-Family Dwellings. For new construction of single-family dwellings, gray water drainage systems shall be installed and connected to at least one clothes washer and at least one primary shower or bathtub.

F 101.3.1.1 Accessory Dwellings. For new construction of accessory dwellings, gray water drainage systems shall be installed and connected to at least one clothes washer and at least one primary shower or bathtub.

Exception: Where an accessory dwelling is constructed without a clothes washer system, ~~dual drainage plumbing~~ a gray water drainage system shall be installed and connected to at least one primary shower or bathtub.

F 101.3.2 Multi-Family Dwellings. For new construction of multi-family dwellings, gray water drainage systems shall be installed and connected to each common laundry facility and each pool or spa shower.

F 101.3.3 Duplexes. For new construction of duplexes, gray water drainage systems shall be installed and connected to at least one clothes washer and one primary shower or bathtub per dwelling unit.

F 101.4 Additions. Bathroom and laundry room additions in single-family dwellings, duplex dwellings, and accessory dwellings shall require the installation of gray water drainage systems for newly installed showers and washing machines.

F 101.4.1 Alterations and Renovations. Alterations and renovations to a bathroom or laundry room, which alter the drainage piping to showers or washing machines, shall require the installation of gray water drainage piping.

COMMITTEE STATEMENT:

The proposal is being modified to replace the phrase "dual draining plumbing" with "gray water drainage system." This was an oversight as the language was intended to reflect "gray water drainage system" throughout this proposed appendix.

TOTAL ELIGIBLE TO VOTE: 30

VOTING RESULTS: AFFIRMATIVE: 25 NEGATIVE: 3 NOT RETURNED: 2 CRAWFORD, WILLIAMS

EXPLANATION OF NEGATIVE:

KLEIN: I am confused. This section is only about gray water ready collection piping. What about the gray water use piping? At a minimum something about the connections that need to be made ready where the gray water collection piping comes together before entering the sewer piping. This proposal needs to be amended.

KOELLER: I concur with Mr. Gary Klein's comments.

WHITE: This proposal is written to force the specified occupancies to be affected rather than spelling out what to do if one chooses to elect a gray water system. I would say it goes beyond lowering the barriers to using gray water systems and forces everyone most of the way there.



CODES ADMINISTRATION

Proposals

Item #: 130

WEStand 2023 Section: F 201.0, F 201.1

SUBMITTER: Laura Allen
Chair, WE-Stand Gray Water Ready Plumbing Task Group

RECOMMENDATION:
Add new text

F 201.0 Definitions.

F 201.1 General. For the purposes of this appendix, the following definitions shall apply:

Accessory Dwelling. An interior attached, or detached residential structure that is used in connection with, or that is accessory to, a single-family dwelling. Also known as an auxiliary dwelling, accessory dwelling unit (ADU), granny flat, an accessory apartment.

Gray Water Drainage System. Piping, fittings, and appurtenances which separately drain untreated gray water to facilitate the installation of a gray water irrigation or reuse system.

Stub Out. The termination point of gray water drainage piping for future connection to a gray water irrigation or reuse system.

SUBSTANTIATION:

The definitions for "accessory dwelling," "gray water drainage system," and "stub out" have been included to support the remaining recommendations within Appendix F. This terminology is consistent with the intent of this appendix and offers additional necessary guidance for users.

As there may be some confusion when using the phrase "dual drainage plumbing," it was determined that a more specific phrase, "gray water drainage system," should be used, and an appropriate description should be provided.

COMMITTEE ACTION: ACCEPT AS SUBMITTED

TOTAL ELIGIBLE TO VOTE: 30

VOTING RESULTS: AFFIRMATIVE: 28 NOT RETURNED: 2 CRAWFORD, WILLIAMS



Proposals

Item #: 131

WEStand 2023 Section: 602.2, F 301.0 - F 401.2, Table 1201.1

SUBMITTER: Laura Allen
Chair, WE-Stand Gray Water Ready Plumbing Task Group

RECOMMENDATION:
Revise text

602.0 Gray Water Systems.

602.2 Gray Water Collection Piping. ~~New single-family dwellings shall have the a separate waste piping system for all gray water fixtures per the Plumbing Code. The separate piping system shall be piped to outside the building and terminate into an approved Gray Water Diverter Valve per Section 602.5 before connecting to the waste system from non-gray water fixtures.~~

~~**Exception:** Where ground conditions do not provide percolation or where prohibited by the Plumbing Code, Gray water collection piping shall be in accordance with the plumbing code. See Appendix F for guidelines on gray water ready plumbing.~~

F 301.0 Gray Water Drainage System Design.

~~**F 301.1 General.** Gray water drainage systems shall be in accordance with Section F 301.2 through Section F 301.5, the plumbing code, and the Authority Having Jurisdiction. [See Figure F 301.1(1) through Figure F 301.1(9).]~~

~~**F 301.2 Diversion.** Gray water drainage piping shall be diverted downstream of fixture traps and vent connections through a diverter valve. [See Figure F 301.1(1) through Figure F 301.1(5).]~~

~~**Exception:** Gray water drainage piping coming directly from a clothes washer. [See Figure F 301.1(6) and Figure F 301.1(7).]~~

~~**F 301.2.1 Laundry Gray Water Diversion.** Gray water from a clothes washer shall be diverted from the drainage piping, downstream of the fixture trap and vent, or shall be diverted directly from the clothes washer appliance through 1-inch (25 mm) piping.~~

~~**F 301.3 Diverter Valve(s).** The diverter valve(s) shall be readily accessible for operation and clearly indicate the direction of flow. The gray water diversion port shall be plumbed to a stub out that is capped off for future use until a gray water irrigation/reuse system is installed. The diverter valve shall be left in the open position to the building sewer. A means of automatic or manual operation shall be provided for control of the diverter valve(s).~~

~~**Note:** Where actuators are to be used as a means of controlling the diverter valve(s), an electrical outlet should be located within 10 feet (3048 mm) of the diverter valve for power connection, unless the valve is controlled by an external controller providing power for the valve.~~

~~**F 301.4 Backwater Valve.** Gray water drainage plumbing subject to backflow shall be provided with a backwater valve. The valve shall be accessible for inspection and maintenance. [See Figure F 301.1(1) through Figure F 301.1(5).]~~

~~**F 301.5 Stub Out(s).** Stub outs shall be identified in accordance with Section 401.0 and shall be readily accessible for future connection to a gray water irrigation or reuse system. [See Figure F 301.1(1) through Figure F 301.1(7).]~~

~~**F 301.5.1 Electrical Requirements.** A dedicated 120V electrical receptacle shall be located not more than 10 feet (3048 mm) from a gray water stub out. All wiring and electrical equipment shall comply with NFPA 70.~~

~~**Exception:** Gray water drainage piping from a clothes washer system that diverts directly from the appliance. [See Figure F 301.1(6) and Figure F 301.1(7).]~~

~~**Note:** A dedicated electrical receptacle is required to ensure that power is available for a future gray water system pump.~~

F 401.0 Identification.

F 401.1 General. Gray water piping and stub out(s) shall be clearly identified with a label having a purple (Pantone color No. 512, 522C, or equivalent) background and black uppercase lettering. Labeling shall be field or factory marked as follows: "CAUTION: NONPOTABLE GRAY WATER, DO NOT DRINK"

F 401.2 Cleanout Labeling. Cleanouts for drains that pass through a backwater valve shall be clearly identified with a permanent label stating: "BACKWATER VALVE DOWNSTREAM"

**TABLE 1201.1
REFERENCED STANDARDS**

STANDARD NUMBER- YEAR	STANDARD TITLE	REFERENCED SECTION
NFPA 70-2020*	National Electrical Code	F 301.5.1

(portion of table not shown remains unchanged)

Note: NFPA 70 meets the requirements for a mandatory referenced standard in accordance with Section 15.0 of IAPMO's Regulations Governing Consensus Development of the Water Efficiency and Sanitation Standard.

SUBSTANTIATION:

Section 602.2 directs new single-family dwellings to have a separate waste piping system for gray water fixtures "per the Plumbing Code" but no current plumbing codes have this requirement. This means the existing language in Section 602.2 does not require gray water collection piping to be installed anywhere. In summary, the revisions remove incorrect language and support the other recommendations generated by this Task Group.

Section F 301.0 offers detailed design requirements for gray water drainage systems. Since these design requirements take into account the future installation of gray water irrigation or reuse systems, it was necessary to address diverter valves, backwater valves, stub outs, and electrical requirements. This section includes details of how to construct the piping system, where to locate the diverter valve, when and where to include backwater valves.

Notes have also been provided where additional clarification or explanation was required. In particular, a note has been provided under electrical requirements since some systems require power for pump operation. Furthermore, Section F 401.0 has been included as it addresses the identification and labeling of gray water piping and stub out(s).

COMMITTEE ACTION: ACCEPT AS SUBMITTED

TOTAL ELIGIBLE TO VOTE: 30

VOTING RESULTS: AFFIRMATIVE: 28 NOT RETURNED: 2 CRAWFORD, WILLIAMS

EXPLANATION OF AFFIRMATIVE:

TABAKH: References to specific plumbing code sections should identify the plumbing code as the UPC and the applicable edition.



CODES ADMINISTRATION

Proposals

Item #: 132

WEStand 2023 Section: Figure F 301.1(1) - Figure F 301.1(9)

SUBMITTER: Laura Allen
Chair, WE-Stand Gray Water Ready Plumbing Task Group

RECOMMENDATION:
Add new text

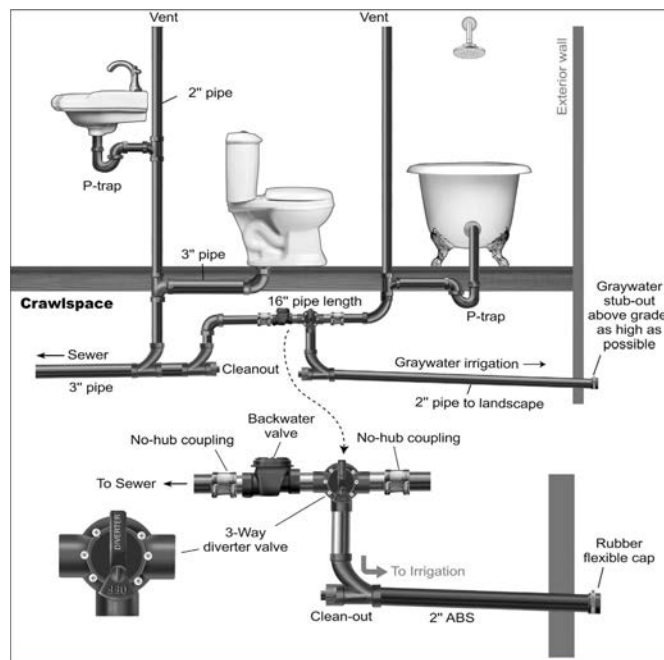

FIGURE F 301.1(1)
GRAY WATER DRAINAGE SYSTEM- DIVERTER VALVE IN CRAWL SPACE

For SI units: 1 inch = 25 mm

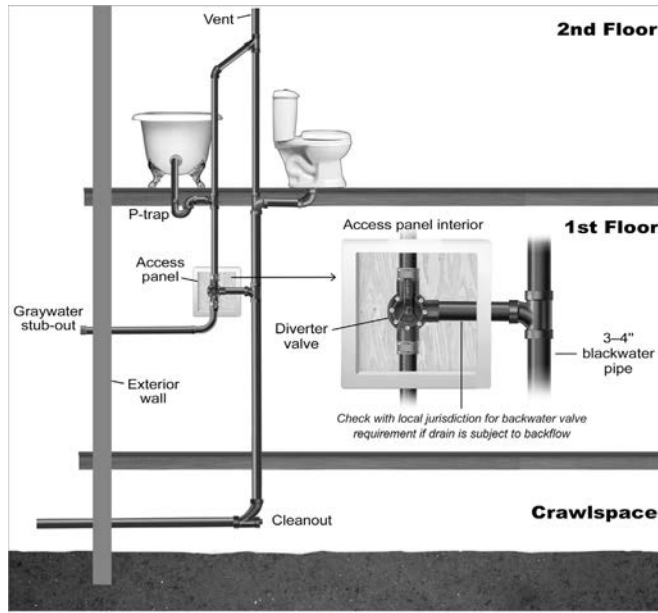

FIGURE F 301.1(2)_
GRAY WATER DRAINAGE SYSTEM – SINGLE FIXTURE ON SECOND FLOOR NEAR EXTERIOR WALL

For SI units: 1 inch = 25 mm

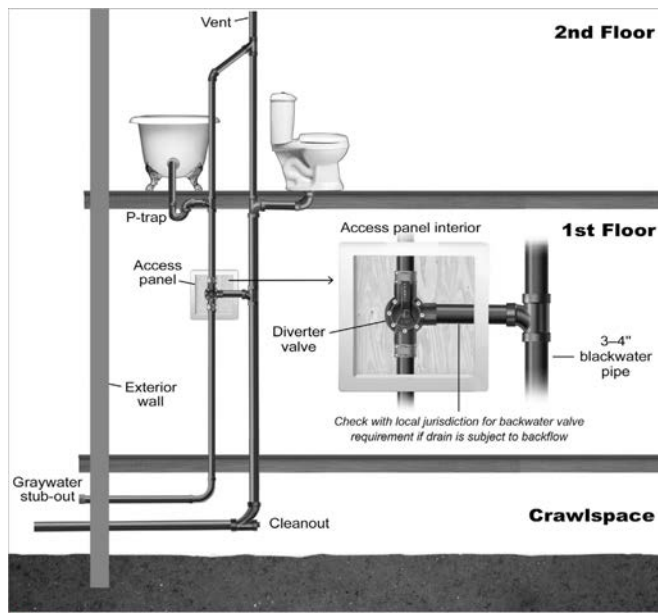
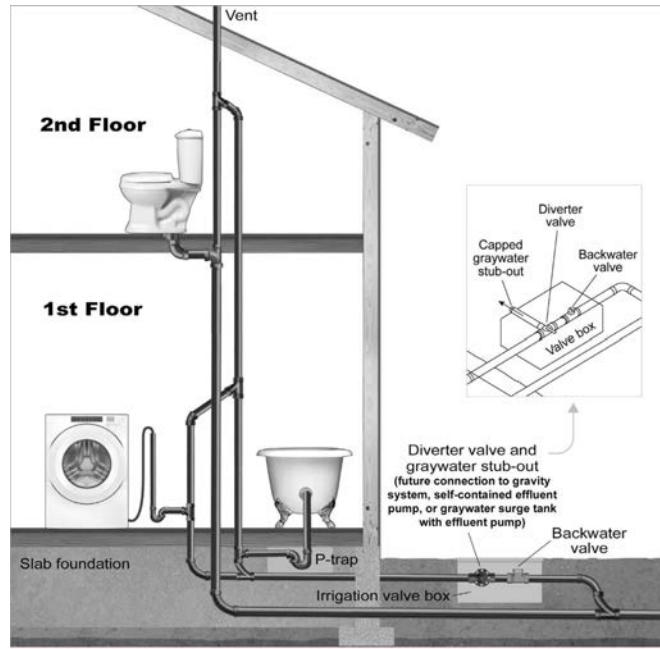

FIGURE F 301.1(3)_
GRAY WATER DRAINAGE SYSTEM – SINGLE FIXTURE ON SECOND FLOOR WITH STUB-OUT ABOVE GRADE, FROM CRAWL SPACE UNDER THE FIRST FLOOR

For SI units: 1 inch = 25 mm



**FIGURE F 301.1(4).
GRAY WATER DRAINAGE SYSTEM – MULTIPLE FIXTURES ON CONCRETE SLAB FOUNDATION**

For SI units: 1 inch = 25 mm

Note: A dedicated electrical receptacle should be installed not less than 10 feet (3048 mm) away from the stub out to ensure that power is available for a future gray water system pump.

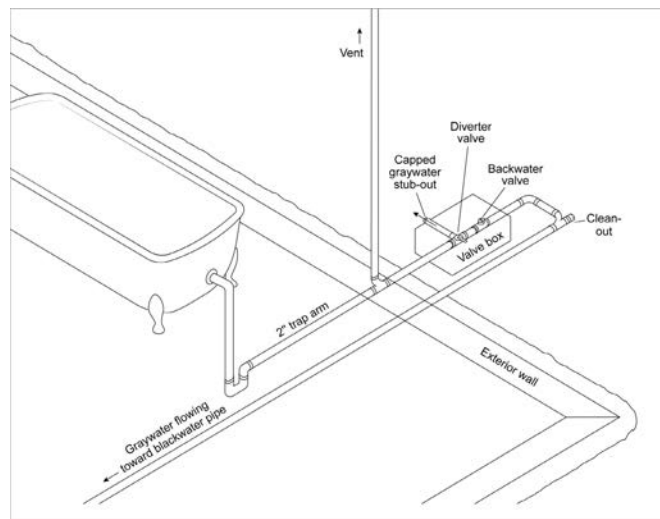

**FIGURE F 301.1(5).
GRAY WATER DRAINAGE SYSTEM – GRAYWATER PIPING EXTENDS OUTSIDE SLAB FOR ACCESS, THEN RETURNS INTO SLAB TO JOIN OTHER DRAINAGE PIPING**

For SI units: 1 inch = 25 mm

Note: A dedicated electrical receptacle should be installed not less than 10 feet (3048 mm) away from the stub out to ensure that power is available for a future gray water system pump.

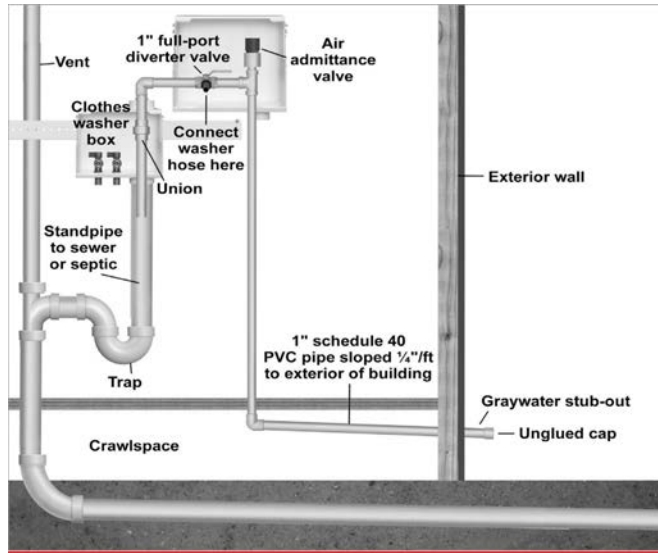
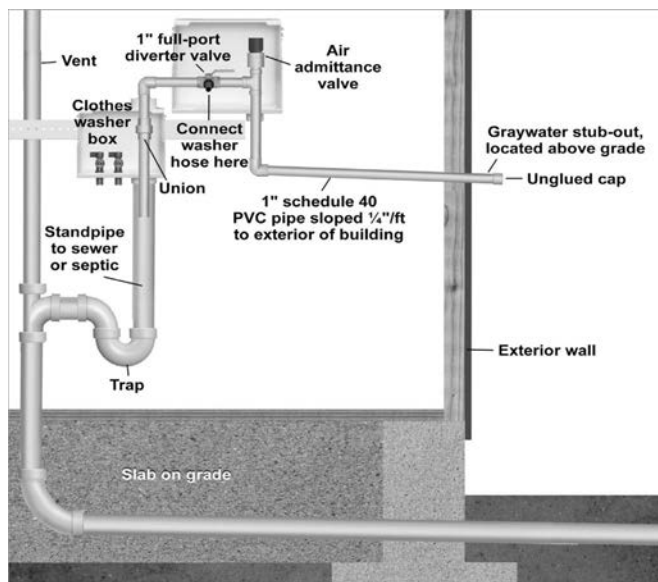

**FIGURE F 301.1(6).
GRAY WATER DRAINAGE SYSTEM – CLOTHES WASHER GRAYWATER SYSTEM WHERE GRAYWATER
IRRIGATION PIPE IS RUN THROUGH CRAWLSPACE**

For SI units: 1 inch = 25 mm

Notes:

- 1_The union is necessary to provide access for maintenance of the standpipe and trap.
- 2_The air admittance valve prevents accidental siphoning of the washing machine and is installed at the highest elevation of the piping on the irrigation side of the diverter valve.



**FIGURE F 301.1(7).
GRAY WATER DRAINAGE SYSTEM – CLOTHES WASHER GRAYWATER SYSTEM WHERE CLOTHES WASHER IS
NEAR AN EXTERIOR WALL OR ON A CONCRETE SLAB FOUNDATION**

For SI units: 1 inch = 25 mm

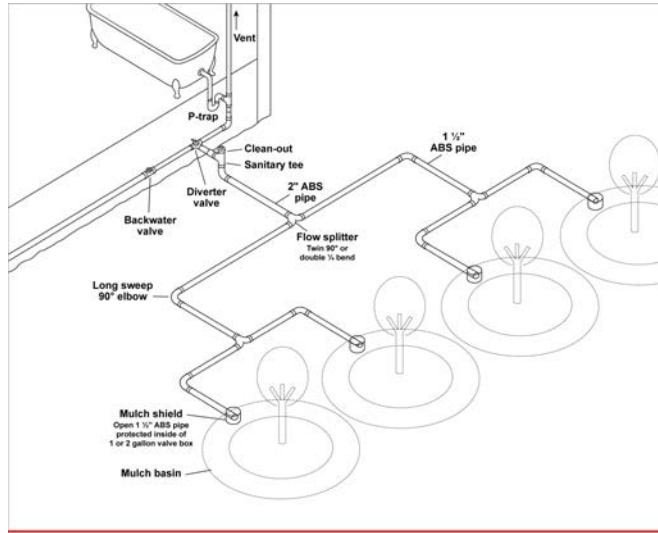

**FIGURE F 301.1(8)
OVERVIEW OF A GRAVITY-FLOW, BRANCHED DRAIN SYSTEM**

For SI units: 1 inch = 25 mm

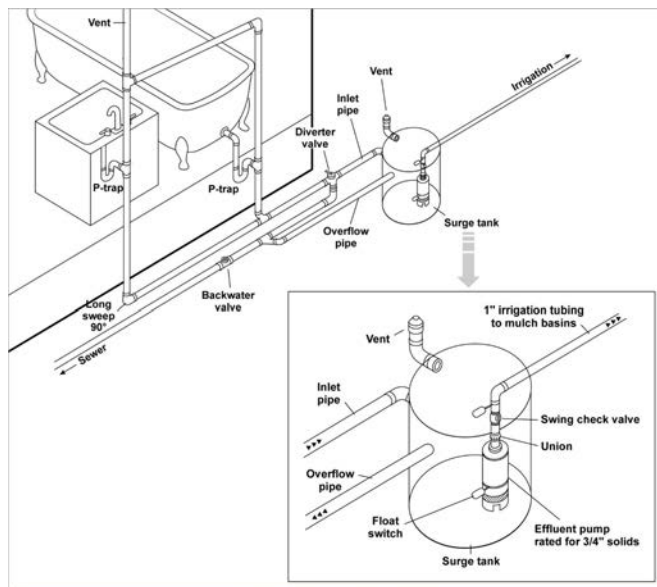

**FIGURE F 301.1(9)
OVERVIEW OF PUMPED GRAYWATER TO IRRIGATION SYSTEM**

For SI units: 1 inch = 25 mm

Notes:

¹ Check with AHJ for surge tank venting requirements.

² A dedicated electrical receptacle should be installed not less than 10 feet (3048 mm) away from the stub out or pump basin to ensure that power is available for a future gray water system pump.

SUBSTANTIATION:

Figure F 301.1(1) through Figure F 301.1(9) have been included to assist users of the appendix in visualizing the listed requirements. Offering a wide variety of detailed figures ensures that provisions are understood and implemented correctly.

Figure F 301.1(1) illustrates graywater being collected from a first-floor shower/bath, with the diverter valve located in the crawlspace or basement.

Figure F 301.1(2) shows graywater being collected from a second-story shower/bath, with the diverter valve located below the bathroom inside the wall of the first floor.

Figure F 301.1(3) shows the same plumbing set-up as installed in Figure F 301.1(2), except the shower/bath drain pipe runs through the first floor and into the crawlspace. The graywater stub-out is located outside of the exterior crawl space foundation wall or crawl space vent, above grade. This configuration may be applicable when fixtures are located in the interior of the building and a stub-out can't be piped easily through an exterior wall above floor level.

Figure F 301.1(4) shows graywater diversion from the shower/bath and clothes washing machine in a house with a slab-on-grade foundation, where the diverter valve is located outside the building envelope in a subsurface enclosure (i.e., an irrigation valve box). The subsurface enclosure containing the diverter valve needs to be permanently accessible (i.e., no structures or hardscape covering it). The diverter valve should be positioned as high as possible in the enclosure to ensure graywater can drain at a 1/4 inch per 12 inch slope into a future gravity irrigation system or pump basin.

Figure F 301.1(5) demonstrates how to make graywater from a tub/shower (or other fixture) accessible when the bathroom is on a slab and the main drain is in another area of the building. The tub/shower drain has been directed through the slab and perimeter foundation to a subsurface enclosure (i.e., an irrigation valve box). A diverter valve and backwater valve are located in the box, providing a graywater stub out. The tub/shower drain then loops back through the foundation and into the slab to proceed to where it connects with the building's other drainage piping. 1/4 inch per 12 inches of slope must be carefully maintained on this loop piping

Figure F 301.1(6) illustrates laundry-to-landscape piping in a building with a crawl space.

Figure F 301.1(7) illustrates laundry to landscape piping in a slab on grade building. A diverter valve is mounted to the wall in an access panel and connected directly to the discharge hose of the clothes washer.

Figure F 301.1(8) demonstrates a conceptual image of how a gravity-flow, branched drain graywater system transports graywater to multiple landscape plants without a storage tank or pump.

Figure F 301.1(9) shows graywater from a lavatory and tub/shower being made available for irrigation. All of figures were gathered from the Guidance on Ordinance Compliance in Illustrations which may be accessed via the following link:
https://localenergycodes.com/download/787/file_path/fieldList/CCGA%20Illustrated%20Compliance%20Guidance.pdf

COMMITTEE ACTION: ACCEPT AS SUBMITTED

TOTAL ELIGIBLE TO VOTE: 30

VOTING RESULTS: AFFIRMATIVE: 27 NEGATIVE: 1 NOT RETURNED: 2 CRAWFORD, WILLIAMS

EXPLANATION OF AFFIRMATIVE:

ALLEN: As the proponent, I plan to check back in with the task group and incorporate the concerns I heard at the TC meeting, for example, not calling-out specific pipe material in the images. I think the images are important to include in the appendix as they turn the concept of graywater ready plumbing into what a builder would actually need to do to comply with it.

EXPLANATION OF NEGATIVE:

WHITE: The illustrations show some issues with this concept. The use of diverter valves seems to show an issue for cleaning out the line through the diverter valve, and it does not appear they are sanitary pattern valves. Also, the use of splitter fittings (double elbows) would present cleanout issues.



CODES ADMINISTRATION

Proposals

Item #: 133

WEStand 2023 Section: Appendix G, Table 1201.1

SUBMITTER: Kent Sovocool
Chair, WE-Stand Efficiency Rating Task Group

RECOMMENDATION:
Add new text

APPENDIX G **WATER EFFICIENCY RATINGS**

G 101.0 General.

G 101.1 Applicability. This appendix establishes criteria for the use of water efficiency ratings applicable to residential properties containing single-family dwellings. Properties shall also meet the water efficiency and conservation requirements specified in Section 402.0 and Section 403.0, as applicable to residential applications.

G 102.0 Water Efficiency Ratings.

G 102.1 General. Properties shall be evaluated for water efficiency by one of the following methods:

- (1) EPA WaterSense Specification for Homes,
- (2) RESNET/ICC 850, or
- (3) Water Efficiency Rating Score (WERS)

G 102.2 Compliance. The rated proposed design and confirmed built property shall have a water efficiency rating not exceeding 65 when compared to the water rating's reference design.

Exception: Where the EPA WaterSense Specification for Homes is used to evaluate water efficiency, the property shall be certified to the WaterSense labeled home specification.

G 102.3 Validation. Properties shall be inspected for compliance by a home verifier, certified rater, or rating field inspector based on the water efficiency rating methodology and certifying agency selected.

G 102.4 Certification. Where properties are certified for compliance, a certificate shall be provided to the property owner including the following information:

- (1) Name of the certifying organization.
- (2) Address of the property.
- (3) Water efficiency rating assigned.
- (4) Name of the verifier, rater, or inspector.
- (5) Date of certification.

G 102.5 Additional Documentation. Upon request, the following documentation shall be provided to the Authority Having Jurisdiction:

- (1) Documentation with the property component characteristics of the water rating reference design.
- (2) A certification signed by the builder or property owner providing the property component characteristics of the rated proposed design.
- (3) Documentation of the actual values used in the water rating calculations for the confirmed built property.

**TABLE 1201.1
REFERENCED STANDARDS**

STANDARD NUMBER- YEAR	STANDARD TITLE	REFERENCED SECTION
EPA WaterSense-2021	Specification for Homes	G 102.1, G 102.2
RESNET/ICC 850-2020*	Calculation and Labeling of the Water Use Performance of One- and Two-Family Dwellings Using the Water Rating Index	G 102.1

(portion of table not shown remains unchanged)

Note: The EPA WaterSense Specification for Homes and RESNET/ICC 850 meet the requirements for mandatory referenced standards in accordance with Section 15.0 of IAPMO's Regulations Governing Consensus Development of the Water Efficiency and Sanitation Standard.

SUBSTANTIATION:

The proposed new appendix supports water efficient residential design by providing available methodologies and validation measures along with appropriate backstops. Since there are multiple water efficiency rating systems, all with their own approach for determining efficiencies, the Task Group consulted with representatives from both RESNET and WERS to ensure compatibility with the proposed language.

Additionally, a representative from EPA WaterSense assisted the Task Group with ensuring the reference to the Specification for Homes was appropriately addressed. This review was pertinent for clarity on the intent of the listed methodologies since the Specification for Homes utilizes available rating systems to compare efficiencies with standard construction.

The language in Section G 102.3 through Section G 102.5 adds basic requirements for validation and certification based on the selected method of evaluating water efficiency. For evident reasons, the residential property must be inspected for compliance by a home verifier, certified rater, or rating field inspector.

Such language is beneficial as these water efficiency evaluation methods and agencies allow for independent confirmation of the water-saving practices of residential projects. Furthermore, the proposed language is designed to help expand the reach of WE•Stand into the single-family sector. For these reasons, the proposal is valuable to the code and promotes more sustainable requirements for water efficiency and conservation.

The EPA WaterSense Specification for Homes may be accessed via the following link:

https://www.epa.gov/sites/default/files/2021-02/documents/watersense_final_homes_specification_v2.0.pdf

Information pertaining to WERS may be accessed via the following link:

<https://www.wers.us/>

COMMITTEE ACTION: ACCEPT AS AMENDED BY THE TC

**APPENDIX G
WATER EFFICIENCY RATINGS**

G 101.0 General.

G 101.1 Applicability. This appendix establishes criteria for the use of water efficiency ratings applicable to residential properties containing single-family dwellings. Properties shall also meet the water efficiency and conservation requirements specified in Section 402.0 and Section 403.0, as applicable to residential applications.

G 102.0 Water Efficiency Ratings.

G 102.1 General. Properties shall be evaluated for water efficiency by one of the following methods:

- (1) EPA WaterSense Specification for Homes,
- (2) RESNET/ICC 850, or
- (3) Water Efficiency Rating Score (WERS)

Exception: Where the property to be rated includes a water softener, the Water Efficiency Rating Score (WERS) or the EPA WaterSense Specification for Homes shall be used.

G 102.2 Compliance. The rated proposed design and confirmed built property shall have a water efficiency rating not exceeding 65 when compared to the water rating's reference design.

Exception: Where the EPA WaterSense Specification for Homes is used to evaluate water efficiency, the property shall be certified to the WaterSense labeled home specification.

G 102.3 Validation. Properties shall be inspected for compliance by a home verifier, certified rater, or rating field inspector based on the water efficiency rating methodology and certifying agency selected.

G 102.4 Certification. Where properties are certified for compliance, a certificate shall be provided to the property owner including the following information:

- (1) Name of the certifying organization.
- (2) Address of the property.
- (3) Water efficiency rating assigned.
- (4) Name of the verifier, rater, or inspector.
- (5) Date of certification.

G 102.5 Additional Documentation. Upon request, the following documentation shall be provided to the Authority Having Jurisdiction:

- (1) Documentation with the property component characteristics of the water rating reference design.
- (2) A certification signed by the builder or property owner providing the property component characteristics of the rated proposed design.
- (3) Documentation of the actual values used in the water rating calculations for the confirmed built property.

**TABLE 1201.1
REFERENCED STANDARDS**

STANDARD NUMBER-YEAR	STANDARD TITLE	REFERENCED SECTION
EPA WaterSense-2021	Specification for Homes	G 102.1, G 102.2
RESNET/ICC 850-2020*	Calculation and Labeling of the Water Use Performance of One- and Two-Family Dwellings Using the Water Rating Index	G 102.1

(portion of table not shown remains unchanged)

COMMITTEE STATEMENT:

The Water Efficiency Rating Score (WERS) and the EPA WaterSense Specification for Homes promote water conservation for water softeners in ways that do not contradict established North American Standards. Meanwhile, the RESENT/ICC 850 rating system is inconsistent with those established standards, and the adoption of RESNET/ICC 850 would cause unintended consequences.

TOTAL ELIGIBLE TO VOTE: 30

VOTING RESULTS: AFFIRMATIVE: 17 NEGATIVE: 11 NOT RETURNED: 2 CRAWFORD, WILLIAMS

Note: Item # 133 failed to achieve the necessary two-thirds affirmative vote of returned ballots. In accordance with Section 6.8.2 of the Regulations Governing Consensus Development of the Water Efficiency and Sanitation Standard, a public comment is requested for this proposal. The Technical Committee will reconsider this proposal as a public comment.

EXPLANATION OF AFFIRMATIVE:

BARNES: The amendment to the proposal is necessary as the RESNET/ICC 850 efficiency rating system restricts softening below 10 grains of hardness per gallon of water (gpg) which is inconsistent with long established North American Standards. The current definition of soft water and softening established within North American Standards is based on removing hardness down to <1gpg. Multiple industries rely upon these North American Standards for product design and warranties. Therefore, using the RESNET/ICC rating system on homes that include a water softener will have unintended consequences for many American homeowners and other stakeholders.

KENDZEL: I am in support of the amendment to the proposal. Based on the concerns raised by the WQA representative during the meeting, I believe the proponent of the proposal needs to provide a sound technical justification for penalizing water softeners used in homes based on a limit of 10 grains of hardness per gallon as well as the potential impact of this limitation on both the industry and the consumer. The RESNET standard provides an equation on this issue but the proponent of the proposal 131 provides no technical rationale for the use of the 10 gpg. Until this issue is resolved I am uncomfortable not having an exception for water softeners in the proposal, as approved by the Committee at our June meeting. I am comfortable in having an exception for one of the three Water Efficiency programs for water heaters since there are two other options available.

MCLEOD: I do not see enough technical justification to support the limitation.

EXPLANATION OF NEGATIVE:

ALLEN: I agree with the other comments. I support the original proposal but not the amendment.

KLEIN: I agree with the proposal, but not the amendment. In most cases, water used for drinking should not be softened, but in most retrofit systems all of the water is softened because the system is installed on all of the piping to the building. In addition, the recommended level of softening is too much. And, the sizing of the softeners is based on very unrealistic amounts of water use. The RESNET standard was heavily debated, and its recommendation should stand, perhaps even strengthened.

KOELLER: The proposed committee action would preclude the ANSI/RESNET/ICC 850 water efficiency rating system in any home with a water softener. The assertion that North American standards are "contradicted" by the use of Standard 850 is unfounded. If Standard 850 actually contradicted any established standard, it should be taken up with ANSI. Instead, with this proposal, a trade association seeks to foster the marketing of water softeners in locations without significantly hard water. Standard 850 does not penalize homes with water softeners, but rather it properly accounts for water softener water use in locations without hard water.

LANDO: The proposed committee action would preclude the ANSI/RESNET/ICC 850 water efficiency rating system in any home with a water softener. The assertion that North American standards are "contradicted" by the use of Standard 850 is unfounded. If Standard 850 actually contradicted any established standard, it should be taken up with ANSI. Instead, with this proposal, a trade association seeks to foster the marketing of water softeners in locations without significantly hard water. Standard 850 does not penalize homes with water softeners, but rather it properly accounts for water softener water use in locations without hard water.

LANSING: I agree with prior comments. Further substantiation is needed for the proposal.

LENGER: Agree with all arguments.

OSANN: The proposed committee action would preclude the ANSI/RESNET/ICC 850 water efficiency rating system in any home with a water softener. The assertion that North American standards are "contradicted" by the use of Standard 850 is unfounded. If Standard 850 actually contradicted any established standard, it should be taken up with ANSI. Instead, with this proposal, a trade association seeks to foster the marketing of water softeners in locations without significantly hard water. Standard 850 does not penalize homes with water softeners, but rather it properly accounts for water softener water use in locations without hard water.

PAPE: The proposed committee action would preclude the ANSI/RESNET/ICC 850 water efficiency rating system in any home with a water softener. The assertion that North American standards are "contradicted" by the use of Standard 850 is unfounded. If Standard 850 actually contradicted any established standard, it should be taken up with ANSI. Instead, with this proposal, a trade association seeks to foster the marketing of water softeners in locations without significantly hard water. Standard 850 does not penalize homes with water softeners, but rather it properly accounts for water softener water use in locations without hard water.

PREMER: Further substantiation is needed for proposal.

SOVOCOOL: Agree with the others and urge all to vote negative on this now with this change (acknowledgement: this was originally from the workgroup I chaired). It is unfortunate this single issue derailed ANSI/RESNET/ICC 850 cross-incorporation.

TABAKH: I agree with the arguments against.



CODES ADMINISTRATION

Proposals

Item #: 134

WEStand 2023 Section: Table 1201.1

SUBMITTER: Nicholas Capezza
PHTA

RECOMMENDATION:
Revise text

**TABLE 1201.1
REFERENCED STANDARDS**

STANDARD NUMBER- YEAR	STANDARD TITLE	REFERENCED SECTION
APSP-14 2014-2019 *	Portable Electric Spa Energy Efficiency	418.3.1

(portion of table not shown remains unchanged)

Note: APSP 14 meets the requirements for a mandatory reference standard in accordance with Section 15.0 of IAPMO's Regulations Governing Consensus Development of the Water Efficiency and Sanitation Standard.

SUBSTANTIATION:
The above revision reflects the latest update to the APSP standard that is referenced in Table 1201.1.

COMMITTEE ACTION: ACCEPT AS SUBMITTED

TOTAL ELIGIBLE TO VOTE: 30

VOTING RESULTS: AFFIRMATIVE: 28 NOT RETURNED: 2 CRAWFORD, WILLIAMS



CODES ADMINISTRATION

Proposals

Item #: 135

WEStand 2023 Section: Table 1201.1

SUBMITTER: Karl Aittaniemi
ICC

RECOMMENDATION:
Revise text

**TABLE 1201.1
REFERENCED STANDARDS**

STANDARD NUMBER- YEAR	STANDARD TITLE	REFERENCED SECTION
ASABE/ICC 802- 2014 <u>2020*</u>	Landscape Irrigation Sprinkler and Emitter Standard	415.8, 415.13, 415.13.4

(portion of table not shown remains unchanged)

Note: ASABE/ICC 802 meets the requirements for a mandatory referenced standard in accordance with Section 15.0 of IAPMO's Regulations Governing Consensus Development of the Water Efficiency and Sanitation Standard.

SUBSTANTIATION:
The above revision reflects the latest update to the ICC standard that is referenced in Table 1201.1.

COMMITTEE ACTION: ACCEPT AS SUBMITTED

TOTAL ELIGIBLE TO VOTE: 30

VOTING RESULTS: AFFIRMATIVE: 28 NOT RETURNED: 2 CRAWFORD, WILLIAMS



CODES ADMINISTRATION

Proposals

Item #: 136

WEStand 2023 Section: Table 1201.1

SUBMITTER: Emily Toto
ASHRAE

RECOMMENDATION:
Revise text

**TABLE 1201.1
REFERENCED STANDARDS**

STANDARD NUMBER- YEAR	STANDARD TITLE	REFERENCED SECTION
ANSI/ASHRAE/IES 90.1-2016 (I-P) 2019*	Energy Standard for Buildings Except Low-Rise Residential Buildings	1004.6, Table 1005.2
ANSI/ASHRAE 146-2011 2020*	Methods of Testing for Rating Pool Heaters	Table 1005.2

(portion of table not shown remains unchanged)

Note: The ASHRAE standards meet the requirements for mandatory referenced standards in accordance with Section 15.0 of IAPMO's Regulations Governing Consensus Development of the Water Efficiency and Sanitation Standard.

SUBSTANTIATION:

The above revisions reflect the latest updates to the ASHRAE standards that are referenced in Table 1201.1.

COMMITTEE ACTION: ACCEPT AS SUBMITTED

TOTAL ELIGIBLE TO VOTE: 30

VOTING RESULTS: AFFIRMATIVE: 28 NOT RETURNED: 2 CRAWFORD, WILLIAMS



CODES ADMINISTRATION

Proposals

Item #: 137

WEStand 2023 Section: Table 1201.1

SUBMITTER: Angel Guzman Rodriguez
ASME

RECOMMENDATION:
Revise text

**TABLE 1201.1
REFERENCED STANDARDS**

STANDARD NUMBER- YEAR	STANDARD TITLE	REFERENCED SECTION
ASME A112.14.6-2010 (R2015-R2019)*	FOG (Fats, Oils, and Greases) Disposal Systems	407.4.1
ASME A112.19.19-2016 (R2021)*	Vitreous China Nonwater Urinals	402.3.2

(portion of table not shown remains unchanged)

Note: The ASME standards meet the requirements for mandatory referenced standards in accordance with Section 15.0 of IAPMO's Regulations Governing Consensus Development of the Water Efficiency and Sanitation Standard.

SUBSTANTIATION:

The above revisions reflect the latest updates to the ASME standards that are referenced in Table 1201.1.

COMMITTEE ACTION: ACCEPT AS SUBMITTED

TOTAL ELIGIBLE TO VOTE: 30

VOTING RESULTS: AFFIRMATIVE: 28 NOT RETURNED: 2 CRAWFORD, WILLIAMS



CODES ADMINISTRATION

Proposals

Item #: 138

WEStand 2023 Section: Table 1201.1

SUBMITTER: Steve Mawn
ASTM

RECOMMENDATION:
Revise text

**TABLE 1201.1
REFERENCED STANDARDS**

STANDARD NUMBER-YEAR	STANDARD TITLE	REFERENCED SECTION
ASTM F2831- 2012-(R2017) <u>2019*</u>	Standard Practice for Internal Non Structural Epoxy Barrier Coating <u>of</u> Material Used in Rehabilitation of Metallic Pressurized Piping Systems	303.2

(portion of table not shown remains unchanged)

Note: ASTM F2831 meets the requirements for a mandatory referenced standard in accordance with Section 15.0 of IAPMO's Regulations Governing Consensus Development of the Water Efficiency and Sanitation Standard.

SUBSTANTIATION:

The above revision reflects the latest update to the ASTM standard that is referenced in Table 1201.1.

COMMITTEE ACTION: ACCEPT AS SUBMITTED

TOTAL ELIGIBLE TO VOTE: 30

VOTING RESULTS: AFFIRMATIVE: 28 NOT RETURNED: 2 CRAWFORD, WILLIAMS



CODES ADMINISTRATION

Proposals

Item #: 139

WESand 2023 Section: Table 1201.1

SUBMITTER: Lauro Pilla / Nikki Kidd
CSA

RECOMMENDATION:
Revise text

**TABLE 1201.1
REFERENCED STANDARDS**

STANDARD NUMBER-YEAR	STANDARD TITLE	REFERENCED SECTION
CSA/ANSI Z21.10.3-2017 <u>2019/CSA 4.3-2019*</u>	Gas-Fired Water Heaters, Volume III, Storage Water Heaters W with Input Ratings Above 75,000 BTU per Hour, e Circulating and Instantaneous (same as CSA 4.3)	Table 1005.2

(portion of table not shown remains unchanged)

Note: CSA/ANSI Z21.10.3/CSA 4.3 meets the requirements for a mandatory referenced standard in accordance with Section 15.0 of IAPMO's Regulations Governing Consensus Development of the Water Efficiency and Sanitation Standard.

SUBSTANTIATION:

The above revision reflects the latest update to the CSA standard that is referenced in Table 1201.1.

COMMITTEE ACTION: ACCEPT AS SUBMITTED

TOTAL ELIGIBLE TO VOTE: 30

VOTING RESULTS: AFFIRMATIVE: 28 NOT RETURNED: 2 CRAWFORD, WILLIAMS



CODES ADMINISTRATION

Proposals

Item #: 140

WEStand 2023 Section: Table 1201.1

SUBMITTER: Robert Pickering
Eastern Research Group, Inc. (ERG)
Environmental Protection Agency (EPA)

RECOMMENDATION:
Revise text

**TABLE 1201.1
REFERENCED STANDARDS**

STANDARD NUMBER-YEAR	STANDARD TITLE	REFERENCED SECTION
EPA WaterSense- 2010 2018	Specification for Showerheads	402.6
EPA WaterSense- 2011 2021	Specification for Weather-Based Irrigation Controllers	415.6

(portion of table not shown remains unchanged)

Note: The EPA WaterSense Specifications meet the requirements for mandatory referenced standards in accordance with Section 15.0 of IAPMO’s Regulations Governing Consensus Development of the Water Efficiency and Sanitation Standard.

SUBSTANTIATION:
The above revisions reflect the latest updates to the EPA WaterSense Specifications that are referenced in Table 1201.1.

A minor revision to the WaterSense Specification for Showerheads was published by EPA in 2018. The revision was made to permit high-efficiency rain showers to earn the WaterSense label. All water efficiency and performance criteria remained effectively the same.

EPA published a minor revision to its WaterSense Specification for Weather-Based Irrigation Controllers in 2021. The minor revision adopted the ASABE S627 standard, which is an ANSI standard that was developed to align with the original test method from the WaterSense specification. It also incorporated multiple technical clarifications that EPA issued over the years. The water efficiency and performance criteria of the specification were not changed.

These EPA WaterSense Specifications may be accessed via the following links:
<https://www.epa.gov/sites/default/files/2018-07/documents/ws-products-specification-showerheads-v1-1.pdf>
<https://www.epa.gov/system/files/documents/2021-09/ws-outdoor-product-specification-wbic-revised-v1.1.pdf>

COMMITTEE ACTION: ACCEPT AS SUBMITTED

TOTAL ELIGIBLE TO VOTE: 30

VOTING RESULTS: AFFIRMATIVE: 28 NOT RETURNED: 2 CRAWFORD, WILLIAMS



CODES ADMINISTRATION

Proposals

Item #: 141

WEStand 2023 Section: Table 1201.1

SUBMITTER: Terry Burger
IAPMO

RECOMMENDATION:
Revise text

**TABLE 1201.1
REFERENCED STANDARDS**

STANDARD NUMBER- YEAR	STANDARD TITLE	REFERENCED SECTION
IAPMO IGC 115-2013 ^{e1}	Automatic Water Leak Detection and Control Devices	409.1
IAPMO IGC 207-2009a	Reclaimed Water Conservation System for Flushing Toilets WITHDRAWN	604.7
IAPMO IGC 324-2016 ^{e1} 2019	Alternate Water Source Systems for Single-Family Dwellings-Multi-Family, Residential, and Commercial Use	Table 702.9(2), Table 802.9(2)
ANSI/CAN/IAPMO IGC 349 Z1349-2018-2021*	Electronic Plumbing Supply System Integrity Protection Devices for Detection, Monitoring or Control of Plumbing Systems	409.1
IAPMO PS 76-2012a 2021	Trap Primers for Fill Valves and Flushometer Valves	416.1
IAPMO/ANSI UMC 1-2018 2021*	Uniform Mechanical Code	101.6.3
IAPMO/ANSI UPC 1-2018 2021*	Uniform Plumbing Code	103.6.4
IAPMO/ANSI USEG USHGC 1-2018-2021*	Uniform Solar Energy, Hydronics and Geothermal Code	101.6.5
IAPMO/ANSI USPSHTC 1-2018-2021*	Uniform Swimming Pool, Spa, and Hot Tub Code	101.6.6

(portion of table not shown remains unchanged)

Note: The IAPMO standards meet the requirements for mandatory referenced standards in accordance with Section 15.0 of IAPMO's Regulations Governing Consensus Development of the Water Efficiency and Sanitation Standard.

SUBSTANTIATION:

The above revisions reflect the latest updates to the IAPMO standards that are referenced in Table 1201.1. ANSI/CAN/IAPMO Z1349 supersedes IAPMO IGC 115 and IAPMO IGC 349. Table 1201.1 has been modified to reflect this update.

COMMITTEE ACTION: ACCEPT AS AMENDED BY THE TC

**TABLE 1201.1
REFERENCED STANDARDS**

STANDARD NUMBER-YEAR	STANDARD TITLE	REFERENCED SECTION
<u>IAPMO IGC 115-2013^{e1}</u>	<u>Automatic Water Leak Detection and Control Devices</u>	<u>409.1</u>
IAPMO IGC 324-2019	Alternate Water Source Systems for Multi-Family, Residential, and Commercial Use	Table 702.9(2), Table 802.9(2)
<u>IAPMO IGC 349-2018^{e1}</u>	<u>Electronic Plumbing Supply System Integrity Protection Devices</u>	<u>409.1</u>
ANSI/CAN/IAPMO Z1349-2021*	Devices for Detection, Monitoring or Control of Plumbing Systems	409.1
IAPMO PS 76-2021	Trap Primers for Fill Valves and Flushometer Valves	416.1
IAPMO/ANSI UMC 1-2021*	Uniform Mechanical Code	101.6.3
IAPMO/ANSI UPC 1-2021*	Uniform Plumbing Code	103.6.4
IAPMO/ANSI USHGC 1 2021*	Uniform Solar, Hydronics and Geothermal Code	101.6.5
IAPMO/ANSI USPSHTC 1-2021*	Uniform Swimming Pool, Spa, and Hot Tub Code	101.6.6

(portion of table not shown remains unchanged)

COMMITTEE STATEMENT:

Item #141 is being amended to keep reference to IAPMO IGC 115, IAPMO IGC 349, and ANSI/CAN/IAPMO Z1349. This change is in support of the actions taken by the Technical Committee on Item #055.

TOTAL ELIGIBLE TO VOTE: 30

VOTING RESULTS: AFFIRMATIVE: 28 NOT RETURNED: 2 CRAWFORD, WILLIAMS



CODES ADMINISTRATION

Proposals

Item #: 142

WEStand 2023 Section: Table 1201.1

SUBMITTER: Jeremy Brown
NSF

RECOMMENDATION:
Revise text

**TABLE 1201.1
REFERENCED STANDARDS**

STANDARD NUMBER-YEAR	STANDARD TITLE	REFERENCED SECTION
NSF/ ANSI 14- 2018-2020 *	Plastics Piping System Components and Related Materials	302.1.1
NSF/ ANSI 41-2018*	Non-Liquid Saturated Treatment Systems	502.1.1
NSF/ ANSI 44-2018*	Residential Cation Exchange Water Softeners	406.1
NSF/ ANSI 53- 2018-2020 *	Drinking Water Treatment Units – Health Effects	A 104.3.1
NSF/ ANSI 58- 2018-2020 *	Reverse Osmosis Drinking Water Treatment Systems	406.3
NSF/ ANSI/CAN 61- 2018-2021 *	Drinking Water Systems Components - Health Effects	A 103.2, A 104.5.1
NSF/ ANSI 350- 2019-2020 *	Onsite Residential and Commercial <u>Water</u> Reuse Treatment Systems	601.7, 604.7
NSF P151- 2014-2021	Health Effects from Rainwater Catchment System Components	A 103.1, A 103.2

(portion of table not shown remains unchanged)

Note: The NSF standards meet the requirements for mandatory referenced standards in accordance with Section 15.0 of IAPMO's Regulations Governing Consensus Development of the Water Efficiency and Sanitation Standard.

SUBSTANTIATION:

The above revisions reflect the latest updates to the NSF standards that are referenced in Table 1201.1.

COMMITTEE ACTION: ACCEPT AS SUBMITTED

TOTAL ELIGIBLE TO VOTE: 30

VOTING RESULTS: AFFIRMATIVE: 28 NOT RETURNED: 2 CRAWFORD, WILLIAMS



CODES ADMINISTRATION

Proposals

Item #: 143

WEStand 2023 Section: Table 1201.1

SUBMITTER: Jazmin Curiel
Self

RECOMMENDATION:
Revise text

**TABLE 1201.1
REFERENCED STANDARDS**

STANDARD NUMBER-YEAR	STANDARD TITLE	REFERENCED SECTION
AHRI 1160 (I-P)-2014*	Performance Rating of Heat Pump Pool Heaters	Table 1005.2
ARCSA/ASPE 63- 2013 2020*	Rainwater Catchment Systems	902.1, A 104.9.1
ARCSA/ASPE 78-2015*	Stormwater Harvesting System Design for Direct End-Use Applications	802.1.1

(portion of table not shown remains unchanged)

Note: AHRI 1160, ARCSA/ASPE 63, and ARCSA/ASPE 78 meet the requirements for mandatory referenced standards in accordance with Section 15.0 of IAPMO's Regulations Governing Consensus Development of the Water Efficiency and Sanitation Standard.

SUBSTANTIATION:

The above designations within Table 1201.1 are being updated to include an asterisk where approved as an American National Standard (ANSI). Such changes are for consistency and to ensure all ANSI approved standards are appropriately identified. Additionally, ARCSA/ASPE 63 has been updated to reflect the most recent edition published.

COMMITTEE ACTION: ACCEPT AS SUBMITTED

TOTAL ELIGIBLE TO VOTE: 30

VOTING RESULTS: AFFIRMATIVE: 28 NOT RETURNED: 2 CRAWFORD, WILLIAMS